



# Fischer Panda®

Power  
wherever  
you are™



## Manual Marine Generator

Panda PMS 12.000 NE - 230/400V 50Hz 10,2kW

Panda PMS 12 mini - 120/240V 60Hz 10,2kW (115/230V 60Hz 10,2kW)

Panda PMS 14.000 NE - 230/400V 50Hz 11,9kW - Panda PMS 14 mini - 120/240V 60Hz 11,9kW

Panda PMS 15.000 NE - 230/400V 50Hz 12,7kW

Super silent technology

## Fischer Panda GmbH



## Current revision status

	Document
Actual:	Panda_12000NE-15000NE_PMS_eng.R02.1_3.9.14
Replace:	Panda_12000NE-15000NE_PMS_eng.R02

Revision	Page
Jahresupdate - Bilder Gen getauscht	

### Erstellt durch / created by

Fischer Panda GmbH - Leiter Technische Dokumentation

Otto-Hahn-Str. 32-34

33104 Paderborn - Germany

Tel.: +49 (0) 5254-9202-0

email: [info@fischerpanda.de](mailto:info@fischerpanda.de)

web: [www.fischerpanda.de](http://www.fischerpanda.de)

### Copyright

**Duplication and change of the manual is permitted only in consultation with the manufacturer!**

Fischer Panda GmbH, 33104 Paderborn, reserves all rights regarding text and graphics. Details are given to the best of our knowledge. No liability is accepted for correctness. Technical modifications for improving the product without previous notice may be undertaken without notice. Before installation, it must be ensured that the pictures, diagrams and related material are applicable to the genset supplied. Enquiries must be made in case of doubt.



## Inhalt / Contents

<b>Current revision status</b> .....	<b>2</b>
<b>1 General Instructions and Regulations</b> .....	<b>12</b>
1.1 Safety first!.....	12
1.2 Tools .....	16
1.3 Manufacturer declaration in accordance with the Machinery Directive 2006/42/EC .....	18
1.4 Customer registration and guarantee .....	18
1.4.1 Technical support .....	18
1.4.2 Caution, important information for start-up! .....	18
1.5 Safety Instructions - Safety First! .....	19
1.5.1 Safe operation .....	19
1.5.2 Observe safety instructions! .....	19
1.5.3 Personal protective clothing (PPE) .....	19
1.5.4 Cleanliness ensures safety .....	19
1.5.5 Safe handling of fuels and lubricants .....	20
1.5.6 Exhaust fumes and fire protection .....	20
1.5.7 Safety precautions against burns and battery explosions .....	21
1.5.8 Protect your hands and body from rotating parts! .....	21
1.5.9 Anti-freeze and disposal of fluids .....	21
1.5.10 Implementation of safety inspections and maintenance .....	22
1.6 Warning and instruction signs.....	22
1.6.1 Special instructions and hazards of generators .....	22
1.6.1.1 Protective conductor and potential equalisation:.....	23
1.6.1.2 Protective conductor for Panda AC generators:.....	23
1.6.1.3 Switch off all loads while working on the generator .....	23
1.6.1.4 Potential equalisation for Panda AGT DC generators.....	23
1.6.1.5 Safety instructions concerning cables.....	24
1.6.2 Recommended starter battery sizes .....	24
1.6.3 Important instructions for batteries - starter and/or traction batteries .....	24
1.6.4 General safety instructions for handling batteries .....	25
<b>2 In case of Emergency First Aid / Im Notfall - Erste Hilfe</b> .....	<b>27</b>
2.1 WHEN AN ADULT STOPS BREATHING .....	28
<b>3 Basics</b> .....	<b>29</b>
3.1 Intended use of the machine .....	29
3.1.1 Purpose of the manual and description of the definitions trained person/operator/user .....	29
3.1.1.1 Trained persons .....	29
3.1.2 Operator .....	29
3.1.2.1 User.....	29
3.2 Panda Transport Box.....	30
3.2.1 Bolted Fischer Panda Transport Box .....	30
3.2.2 Fischer Panda Transport Box with metal tab closure .....	30
3.3 Transport and Loading/Unloading .....	30
3.3.1 Transporting the generator .....	30
3.3.2 Loading/unloading of the generator .....	30
3.4 Scope of delivery .....	31
3.4.1 Asynchronous Generator: .....	31
3.4.2 Opening the MPL sound insulation capsule .....	33
3.4.3 Opening the GFK sound insulation capsule .....	33



## Inhalt / Contents

3.5	Special maintenance notes and arrangements at long periods of stand still time or shutdown.....	34
3.5.1	Reference note for the starter battery at a long-term standstill .....	34
3.5.2	Arrangements at a short-term standstill .....	35
3.5.3	Arrangements at a medium-term standstill / winter storage .....	35
3.5.3.1	Arrangements for conservation: .....	35
3.5.3.2	Arrangements for deconservation after a medium-term standstill (3 to 6 months). .....	36
3.5.4	Arrangements at a long-term standstill / shutdown .....	36
3.5.4.1	Arrangements for conservation: .....	36
3.5.4.2	Arrangements after a long-term standstill (shutdown) / recommissioning (more than 6 months): .....	37
<b>4</b>	<b>The Panda Generator .....</b>	<b>39</b>
4.1	Position of Identification plate .....	39
4.2	Description of the Generator .....	40
4.2.1	Generator side view RH .....	40
4.2.2	Generator side view LH .....	41
4.2.3	Generator front view .....	42
4.2.4	Generator back view .....	43
4.2.5	Generator top view .....	44
4.3	Details of functional units .....	45
4.3.1	Control panel .....	45
4.3.2	The Cooling System - Schema .....	46
4.3.3	The Fuel System - Schema .....	47
4.3.4	The operation surveillance system .....	48
4.3.5	The Oil Circuit - Schema .....	50
<b>5</b>	<b>Generator operation instruction .....</b>	<b>51</b>
5.1	Personal requirements .....	51
5.2	Hazard notes for the operation .....	51
5.3	General operating instruction .....	51
5.3.1	Operation at low temperatures .....	51
5.3.1.1	Pre-heating the diesel motor .....	52
5.3.1.2	Tips regarding starter battery .....	52
5.3.2	Light load operation and engine idle .....	52
5.3.2.1	The soot of the generator is due to the fact that: .....	52
5.3.2.2	To prevent the soot of the generator following steps should be observed: .....	52
5.3.3	Generator load for a longer period and overload .....	52
5.3.4	Protection conductor: .....	53
5.3.5	Operating control system on the Fischer Panda generator .....	53
5.4	Instructions for capacitors - not present at all models .....	53
5.5	Checks before start - see remote control panel data sheet .....	53
5.6	Starting the generator - see remote control panel data sheet .....	54
5.7	Stopping the generator - see remote control panel data sheet .....	54
<b>6</b>	<b>Installation Instructions .....</b>	<b>55</b>
6.1	Personal requirements .....	55
6.1.1	Hazard notes for the installation .....	55
6.2	Preparing the base - Placement .....	57
6.2.1	Advice for optimal sound insulation .....	57
6.3	Generator Connections .....	57



## Inhalt / Contents

6.4	Installation of the cooling system - raw water .....	58
6.4.1	General Information .....	58
6.4.2	Installation of the through hull fitting in Yachts .....	58
6.4.3	Quality of the Raw Water Sucking In Line .....	58
6.4.4	Generator Installation above Waterline .....	59
6.4.5	Generator Installation below Water-Line .....	60
6.4.6	Generator Housing cooled by Raw Water .....	61
6.4.7	Indirect Cooling of the Genset Housing (by the Heat Exchanger) .....	62
6.5	Installation of the cooling system - fresh water .....	62
6.5.1	Position of the external cooling water expansion tank .....	62
6.5.2	Ventilating at the first filling of the Internal Cooling Water Circuit .....	63
6.5.3	Pressure Test for Controlling the Cooling Water Circuit .....	64
6.5.4	Scheme for Freshwater Circuit at Two Circuit Cooling System .....	65
6.6	Installation of the water cooled exhaust system .....	66
6.6.1	Installation of the standard exhaust system .....	66
6.7	.Installation of the waterlock .....	67
6.7.1	Possible cause for water in the exhaust hose .....	67
6.7.1.1	Possible cause: exhaust hose.....	67
6.7.1.2	Possible cause: cooling water hose .....	67
6.7.2	Installation area of the waterlock .....	68
6.7.3	The volume of the waterlock .....	68
6.7.3.1	Ideal position of the waterlock.....	70
6.7.3.2	Example of the installation of the waterlock off-center and possible effects: ...	73
6.8	Exhaust / water separator.....	76
6.8.1	Installation exhaust water separator .....	78
6.9	Installation of the fuel system .....	80
6.9.1	General references .....	80
6.9.2	The Electrical Fuel Pump .....	81
6.9.3	Connection of the fuel lines at the tank .....	81
6.9.4	Position of the pre-filter with water separator .....	82
6.9.5	Ventilating air from the fuel system .....	82
6.10	Generator DC system installation .....	83
6.10.1	Connection of the starter battery block .....	83
6.10.2	Connection of the remote control panel - see separate control panel manual .....	86
6.11	Generator AC System Installation .....	87
6.11.1	Installation with looped in AC-Control box .....	87
6.11.2	Installation AC-Box / distribution panel separate connected .....	88
6.11.3	AC-Control Box with VCS and ASB - not all models .....	90
6.11.4	VCS voltage control .....	91
6.11.4.1	Alternative Mini VCS .....	92
6.11.5	Installation with mini VCS mounted at the generator .....	93
6.11.6	Jump start at high starting current (Booster) .....	93
6.11.7	Insulation test .....	94
<b>7</b>	<b>Maintenance Instructions.....</b>	<b>95</b>
7.1	Personal requirements.....	95
7.2	Hazard notes for the maintenance.....	95
7.3	Environmental protection .....	97
7.4	Maintenance interval.....	97



## Inhalt / Contents

7.5	General maintenance instructions .....	97
7.5.1	Checks before each start .....	97
7.5.2	Check of Hoses and rubber parts in the sound insulated capsule .....	98
7.6	Oil Change Intervals .....	98
7.7	Checking oil-level.....	98
7.7.1	Refilling Oil .....	99
7.7.2	After the oil level check and refilling the oil .....	100
7.8	Replacement of engine oil and engine oil filter .....	100
7.8.1	After the oil change .....	102
7.9	Verifying the starter battery and (if necessary) the battery bank.....	103
7.9.1	Battery .....	103
7.9.1.1	Check battery and cable connections .....	103
7.9.1.2	Check electrolyte level .....	103
7.9.1.3	Check electrolyte density .....	103
7.10	Grease lubricated generator backend bearing.....	104
7.10.1	Exchange of grease lubricated bearing .....	105
7.10.1.1	Demounting the cooling disc (if existent).....	105
7.10.1.2	Demounting the backend bearing .....	105
7.10.1.3	Installing the new backend bearing .....	107
7.11	Checking the oil level of the generator end bearing at Fischer Panda generators .....	110
7.11.1	Oil level check .....	110
7.11.2	Refilling oil .....	111
7.11.3	Refiller-Set .....	111
7.11.4	Screw plug .....	111
7.12	Replacement of the oil-cooled backend bearing.....	111
7.12.1	Exchange oil-cooled bearing .....	111
7.12.2	Demounting the bearing .....	111
7.13	Ventilating the fuel system.....	124
7.13.1	Replacement of the fuel filter .....	125
7.13.1.1	Optional fuel filter with sight glass .....	126
7.14	Checking the water separator in the fuel supply .....	128
7.14.1	Replace the air filter mat .....	128
7.14.2	Alternative replacement of the air filter mat with pull out holder .....	129
7.14.3	Alternative replacement of the air filter at housing with snap fasteners .....	131
7.14.4	Ventilation of the coolant circuit / freshwater .....	131
7.15	V-belt replacement for the internal cooling water pump.....	134
7.16	The raw water circuit.....	135
7.16.1	Clean raw water filter .....	135
7.17	Causes with frequent impeller waste .....	136
7.17.1	Replacement of the impeller .....	137
7.18	Replacing the Actuator .....	139
7.18.1	Check and discharge the capacitors .....	141
7.19	Replacing the Electric Starter .....	144
7.20	Replacing the DC/DC Converter .....	147
7.21	Replacing the DC Alternator .....	148
7.22	Replacing the Oil Pressure Switch .....	152
7.22.1	Replacing the oil pressure sensor (optional component) .....	153



## Inhalt / Contents

7.23	Replacing the Operating Current Relays .....	154
7.24	Replacing the fuses .....	155
7.25	Replacing a Thermoswitch .....	156
7.26	Replacing the Injection Nozzles .....	158
7.27	Checking the Flame Glow Plug (optional unit) .....	161
7.27.1	Replacing the Flame Glow Plug .....	162
7.28	Replacing the Stop Solenoid (Energize to stop) .....	163
7.29	Replacing the Glow Plugs .....	167
<b>8</b>	<b>Generator Faults .....</b>	<b>169</b>
8.1	Personal requirements.....	169
8.2	Hazard notes for the troubleshooting.....	169
8.3	Tools and Measuring Instruments .....	171
8.4	Troubleshooting Table and Flowchart .....	172
8.4.1	Generator output voltage too low .....	172
8.4.2	Generator voltage too high (more than 240 V - 50 Hz .....	172
8.4.3	Generator voltage fluctuates .....	172
8.4.4	Generator not able to start electric motor .....	172
8.4.5	Diesel motor fails to start .....	172
8.4.6	Starter is turning motor, but fails to start .....	172
8.4.7	Motor does not achieve enough speed during starting process .....	173
8.4.8	Motor runs unsteady .....	173
8.4.9	Motor speed drops .....	173
8.4.10	Motor runs in off position .....	173
8.4.11	Motor stops by itself .....	174
8.4.12	Sooty, black exhaust .....	174
8.4.13	Generator must be shut off immediately if: .....	174
8.4.14	Troubleshooting for the VCS-Voltage Control .....	174
8.4.15	Troubleshooting Flowcharts .....	175
8.4.15.1	Details and explanations concerning the troubleshooting flowchart .....	177
8.5	Versions of the generator power terminal box .....	181
8.6	Overloading the generator .....	185
8.6.1	Monitoring the Generator Voltage .....	186
8.6.2	Automatic voltage monitoring and auto-shut down .....	186
8.7	Generator-Output Voltage is too low .....	187
8.7.1	Discharging the Capacitors .....	187
8.7.2	Checking the Capacitors .....	188
8.7.2.1	Checking the electrical connections to the capacitors .....	188
8.7.3	Check the Generator Voltage .....	188
8.7.4	Measuring the Ohm Resistance of the Generator Windings .....	189
8.7.5	Check the Windings for Short circuit .....	189
8.7.6	Measuring the Inductive Resistance .....	190
8.8	Generator provides no voltage .....	190
8.8.1	Rotor Magnetism Loss and „Re-magnetising“ .....	190
8.9	Engine Starting Problems .....	191
8.9.1	Electric Fuel Solenoid Valve .....	191
8.9.2	Re-start with Failure Bypass Switch .....	191
8.9.3	Lifting solenoid for motor stop - optional .....	192



## Inhalt / Contents

8.9.4	Troubleshooting Table .....	193
<b>9</b>	<b>Tables .....</b>	<b>195</b>
9.1	Technical Data .....	195
9.2	Rated current .....	200
9.3	Cable cross section .....	200
9.4	Fuel .....	200
9.5	Engine oil .....	201
9.5.1	Engine oil classification .....	201
9.5.1.1	Operating range: .....	201
9.5.1.2	Quality of oil: .....	201
9.6	Coolant specifications .....	202
9.6.1	Coolant mixture ratio .....	202
9.7	Types of coil .....	203
9.7.1	HP1 - 230V / 50 Hz .....	203
9.7.2	HP2 - 120V / 60 Hz .....	203
9.7.3	HP2 - 120V / 60 Hz - Duo .....	203
9.7.4	HP3 - 400V / 50 Hz .....	204
9.7.5	HP2 - 120V / 60 Hz .....	204
9.7.6	DVS - 400V / 50 Hz .....	204
9.7.7	DVS - 120V 240V / 60 Hz .....	205
9.8	Resistor & inductance of the generator coil .....	205
9.9	Voltage values stator coil .....	206
9.10	Diameter of conduits .....	207
	<b>Generator Control Panel P6+ Manual .....</b>	<b>209</b>
	<b>Current revision status .....</b>	<b>210</b>
	<b>Hardware .....</b>	<b>210</b>
<b>10</b>	<b>Safety Instructions Generator Control P6+ .....</b>	<b>211</b>
10.1	Personal requirements .....	211
10.2	Safety instructions .....	211
<b>11</b>	<b>General operation .....</b>	<b>213</b>
11.1	Panel Generator Control .....	213
11.1	Rear view 12 V-version .....	214
11.2	Rear view 24 V-version .....	215
11.3	Installation of the remote control panel .....	216
11.3.1	Placement .....	216
11.3.2	Terminal connections .....	216
11.3.3	Function of the jumpers .....	217
11.3.4	Configuration and adjustment .....	218
11.3.4.1	Configuration and setting sheet KE01 .....	218
11.3.4.2	Configuration and setting sheet KE02 .....	219
11.3.4.3	Configuration and setting sheet KE03 .....	220
11.3.4.4	Configuration and setting sheet KE04 .....	221
11.4	Starting preparation / Checks (daily) .....	222
11.4.1	Marine version .....	222





## Inhalt / Contents

11.4.2	Vehicle version .....	222
11.5	Starting and stopping the generators .....	223
11.5.1	Starting the generator .....	223
11.5.2	Stopping the generator .....	224
11.6	Automatic adapter - optional .....	225
11.6.1	Function: .....	225
11.6.2	The Automatic input: .....	226
11.6.3	Terminal connections .....	227
11.7	Master-Slave adapter - optional.....	227
11.7.1	Fischer Panda Art. No. 21.02.02.015P, 12 V-version .....	227
11.7.2	Fischer Panda Art. No. 21.02.02.01P, 24 V-version .....	228
11.7.3	Terminal Connections: .....	228
11.7.4	Fuse: .....	228
11.7.5	Terminal connections .....	229
11.7.5.1	Terminal X2 (IN/OUT from view Master-Operating-Panel) .....	229
11.7.5.2	Terminal X3.....	229
11.7.6	Configuration and adjustment .....	230
11.7.6.1	Configuration and setting sheet KE05.....	230
11.7.6.2	Configuration and setting sheet KE06.....	231
<b>12</b>	<b>Measurements.....</b>	<b>233</b>
12.1	Hole pattern .....	233



Leere Seite / Intentionally blank



**Dear Customer,**

Thank you for purchasing a Fischer Panda Generator and choosing Fischer Panda as your partner for mobile power on board. With your generator, you now have the means to produce your own power – wherever you are - and experience even greater independence. Not only do you have a Fischer Panda generator on board, you also have worldwide support from the Fischer Panda Team. Please take the time to read this and find how we can support you further.

### **Installation Approval and Warranty**

Every generator has a worldwide warranty. You can apply for this warranty through your dealer when the installation is approved. If you have purchased an extended warranty, please ensure that it is kept in a safe place and that the dealer has your current address. Consult your dealer about warranty options especially if you have purchased a used generator. He will be able to advise about authorised Fischer Panda Services worldwide.

### **Service and Support**

To ensure that your generator operates reliably, regular maintenance checks and tasks as specified in this manual must be carried out. Fischer Panda can supply Service Kits which are ideal for regular servicing tasks. We only supply the highest quality components which are guaranteed to be the RIGHT parts for your generator. Service “Plus” Kits are also available and ideal for longer trips where more than one service interval may be required.

If you require assistance – please contact your Fischer Panda Dealer. Please do not attempt to undertake any repair work yourself, as this may affect your generator warranty. Your dealer will also be able to assist in finding your nearest Fischer Panda service station. Your nearest service station can also be found in our Global Service Network which can be downloaded from our homepage.

### **Product Registration**

Please take the time to register your Fischer Panda Generator on our website at

<http://www.fischerpanda.de/mypanda>

By registering, you will ensure that you will be kept up to date on any technical upgrades or specific information on the operation or servicing of your generator. We can even let you know about new Fischer Panda products – especially helpful if you are planning to upgrade or expand your installation at a later date.

### **Fischer Panda Quality - Tried and Tested**

DIN-certified according DIN ISO 9001

**Thank you for purchasing a Fischer Panda Generator.**

**Your Fischer Panda Team**

# 1. General Instructions and Regulations

## 1.1 Safety first!

---

These symbols are used throughout this manual and on labels on the machine itself to warn of the possibility of personal injury or lethal danger during certain maintenance work or operations. Read these instructions carefully.

Can cause acute or chronic health impairments or death even in very small quantities if inhaled, swallowed, or absorbed through the skin.

**WARNING: Hazardous materials**



This warning symbol draws attention to special warnings, instructions or procedures which, if not strictly observed, may result in damage or destruction of equipment.

**WARNING: Important information!**



Warning of materials that may ignite in the presence of an ignition source (cigarettes, hot surfaces, sparks, etc.).

**WARNING: Fire hazard**



In the environment described / during the work specified, smoking is prohibited.

**PROHIBITED: No smoking**



Fire and naked light are ignition sources that must be avoided.

**PROHIBITED: No fire or naked light**



The equipment shall not be activated or started up while work is in progress.

**PROHIBITED: Do not activate/start up**





Touching of the corresponding parts and systems is prohibited.

**PROHIBITED: Do not touch**



**Danger for life! Working at a running generator can result in severe personal injury.**

**DANGER: Automatic start-up**

The generator can be equipped with a automatic start device. This means, an external signal may trigger an automatic start-up. To avoid an unexpected starting of the generator, the starter battery must be disconnected before working at the generator.



This danger symbol refers to the danger of electric shock and draws attention to special warnings, instructions or procedures which, if not strictly observed, may result in severe personal injury or loss of life due to electric shock.

**WARNING: Hazardous electric voltage**



General warning of a hazard area

**WARNING: General warning**



Can cause acute or chronic health impairments or death even in very small quantities if inhaled or ingested.

**WARNING: Danger due to inhalation and/or ingestion**



Warning of live parts that may cause electric shock upon contact. Especially dangerous for persons with heart problems or pacemakers.

**WARNING: Risk of electric shock upon contact**



Danger of injury due to being pulled into equipment. Bruising and torn off body parts possible. Risk of being pulled in when touching with body part, loose-fitting clothing, scarf, tie, etc.

**WARNING: Danger due to rotating parts**



Warning of substances that may cause an explosion under certain conditions, e.g. presence of heat or ignition sources.

**WARNING: Explosion hazard**

Warning of hot surfaces and liquids. Burn/scalding hazard.

**WARNING: Hot surface**

Warning of substances that cause chemical burns upon contact. These substances can act as contaminants if introduced into the body.

**WARNING: Danger due to corrosive substances, potential contamination of person**

When the system is opened, the pressure can be relieved abruptly and expel hot gases and fluids. Risk of injury due to parts flying about, burn hazard due to liquids and gases.

**WARNING: System may be pressurised!**

Warning of hearing damages.

**WARNING: Hearing damage**

Warning of magnetic field.

**WARNING: Magnetic field**

Warning of overpressure.

**WARNING: Overpressure**



Wearing the applicable snugly fitting protective clothing provides protection from hazards and can prevent damage to your health.

**MANDATORY INSTRUCTION: Wear snugly fitting protective clothing (PPE).**



Wearing hearing protection provides protection from acute and gradual hearing loss.

**MANDATORY INSTRUCTION: Wear hearing protection (PPE).**



Wearing safety goggles protects the eyes from damage. Optical spectacles are not a replacement for the corresponding safety goggles.

**MANDATORY INSTRUCTION: Wear safety goggles (PPE).**



Wearing protective gloves provides the hands from hazards like friction, graze, punctures or deep cuts and protects them from contact with hot surfaces.

**MANDATORY INSTRUCTION: Wear protective gloves (PPE).**



Compliance with the instructions in the manual can avert danger and prevent accidents. This will protect you and the generator.

**MANDATORY INSTRUCTION: Observe the instructions in the manual.**



Environmental protection saves our living environment. For you and for your children.







**MANDATORY INSTRUCTION: Comply with environmental protection requirements.**







### 1.2 Tools

These symbols are used throughout this manual to show which tool must be used for maintenance or installation.

	Spanners W.A.F X = width across flats of X mm
	Hook wrench for oil filter
	Screw driver, for slotted head screws and for Phillips head screws
	Multimeter, multimeter with capacitor measuring unit
	Socket wrench set
	Hexagon socket wrench set



	Clamp-on ammeter (DC for synchronous generators; AC for asynchronous generators)
	Torque wrench



### 1.3 Manufacturer declaration in accordance with the Machinery Directive 2006/42/EC

---

---

Manufacturer declaration in accordance with the Machinery Directive 2006/42/EC

The generator was designed in such a way that all assemblies correspond with the CE guidelines. If Machinery Directive 2006/42/EC is applied, then it is forbidden to start the generator until it has been ascertained that the system into which the generator is to be integrated also complies with the Machinery Directive 2006/42/EC. This includes the exhaust system, cooling system and electrical installations.

The evaluation of "protection against contact" must be carried out when installed, in conjunction with the respective system. This also includes correct electrical connections, a safe ground wire connection, foreign body and humidity protection, protection against moisture due to excessive condensation, as well as overheating through appropriate and inappropriate use of the equipment in its installed state. The responsibility for implementing these measures lies with those who undertake the installation of the generator in the final system.

### 1.4 Customer registration and guarantee

---

---

Use the advantages of registering your product:

- you will receive a Guarantee Certificate after approval of your installation data
- you will receive extended product information that may be relevant to safety.
- You will receive free upgrades as necessary.

Additional advantages:

Based on your complete data record, Fischer Panda technicians can provide you with fast assistance, since 90 % of the disturbances result from defects in the periphery.

Problems due to installation errors can be recognized in advance.

#### 1.4.1 Technical support

---

Technical Support via the Internet: [info@fischerpanda.de](mailto:info@fischerpanda.de)

#### 1.4.2 Caution, important information for start-up!

---

1. The commissioning log shall be filled in immediately after initial operation and shall be confirmed by signature.
2. The commissioning log must be received by Fischer Panda GmbH at Paderborn within 4 weeks of initial operation.
3. After receiving the commissioning log, Fischer Panda will make out the official guarantee certificate and send it to the customer.
4. If warranty claims are made, the document with the guarantee certification must be submitted.

If the above requirements are not or only partly fulfilled, the warranty claim shall become void.



## 1.5 Safety Instructions - Safety First!

---

### 1.5.1 Safe operation

---

Careful handling of the equipment is the best insurance against an accident. Read the manual diligently, and make sure you understand it before starting up the equipment. All operators, regardless of their experience level, shall read this manual and additional pertinent manuals before commissioning the equipment or installing an attachment. The owner shall be responsible for ensuring that all operators receive this information and are instructed on safe handling practices.



### 1.5.2 Observe safety instructions!

---

Read and understand this manual and the safety instructions on the generator before trying to start up and operate the generator. Learn the operating practices and ensure work safety. Familiarise yourself with the equipment and its limits. Keep the generator in good condition.

### 1.5.3 Personal protective clothing (PPE)

---

For maintenance and repair work on the equipment, **do not** wear loose, torn, or ill-fitting clothing that may catch on protruding parts or come into contact with pulleys, cooling disks, or other rotating parts, which can cause severe injury.

Wear appropriate safety and protective clothing during work.



Do not operate the generator while under the influence of alcohol, medications, or drugs.



Do not wear head phones or ear buds while operating, servicing, or repairing the equipment.



### 1.5.4 Cleanliness ensures safety

---

Keep the generator and its environment clean.

Before cleaning the generator, shut down the equipment and secure it against accidental start-up. Keep the generator free from dirt, grease, and waste. Store flammable liquids in suitable containers only and ensure adequate distance to the generator. Check the lines regularly for leakage and eliminate leaks immediately as applicable.



### 1.5.5 Safe handling of fuels and lubricants

Keep fuels and lubricants away from naked fire.

Before filling up the tank and/or applying lubricant, always shut down the generator and secure it against accidental start-up.

Do not smoke and avoid naked flame and sparking near fuels and the generator. Fuel is highly flammable and may explode under certain conditions.

Refuel in well-ventilated open spaces only. If fuel/lubricant was spilled, eliminate fluids immediately.

Do not mix diesel fuel with petrol or alcohol. Such a mixture can cause fire and will damage the generator.

Use only approved fuel containers and tank systems. Old bottles and canisters are not adequate.



### 1.5.6 Exhaust fumes and fire protection

Engine fumes can be hazardous to your health if they accumulate. Ensure that the generator exhaust fumes are vented appropriately (leak-proof system), and that an adequate fresh air supply is available for the generator and the operator (forced ventilation).

Check the system regularly for leakage and eliminate leaks as applicable.

Exhaust gases and parts containing such fumes are very hot; they may cause burns under certain circumstances. Always keep flammable parts away from the generator and the exhaust system.

To prevent fire, ensure that electrical connections are not short-circuited. Check regularly that all lines and cables are in good condition and that there is no chafing. Bare wires, open chafing spots, frayed insulation, and loose cable connections can cause dangerous electric shocks, short-circuit, and fire.


The generator shall be integrated in the existing fire safety system by the operating company.



**CALIFORNIA**

Proposition 65 Warning

Diesel engine exhaust and some of its constituents are known to the State of California to cause cancer, birth defects, and other reproductive harm.



Exhaust gases from diesel motors and some components are carcinogenic and can cause deformities and other genetic defects.





### 1.5.7 Safety precautions against burns and battery explosions

The generator and its cooling agents and lubricants as well as the fuel can get hot while the generator is operated. Use caution around hot components such as parts containing exhaust fumes, radiator, hoses, and engine block during operation and after the generator was shut down.



The cooling system may be pressurised. Open the cooling system only after letting the engine and the coolant cool down. Wear appropriate protective clothing (e.g. safety goggles, gloves).

Prior to operation, ensure that the cooling system is sealed and that all hose clamps are tightened.



The battery represents an explosion hazard, this applies both to the starter battery and the battery bank of the AGT generators. While batteries are being charged, a hydrogen-oxygen mixture is generated, which is highly explosive (electrolytic gas).



Do not use or charge batteries if the fluid level is below the MINIMUM marking. The life span of the battery is significantly reduced, and the risk of explosion increases. Refill to a fluid level between maximum and minimum level without delay.

Especially during charging, keep sparks and naked fire away from the batteries. Ensure that the battery terminals are tightly connected and not corroded to avoid sparking. Use an appropriate terminal grease.



Check the charge level with an adequate voltmeter or acid siphon. Contact of a metal object across the terminals will result in short-circuiting, battery damage, and high explosion risk.

Do not charge frozen batteries. Heat the batteries to +16 °C (61 °F) prior to charging.

### 1.5.8 Protect your hands and body from rotating parts!

Always keep the capsule closed while operating the generator.

To check the V-belt tension, always shut down the generator.

Keep your hands and body away from rotating parts such as V-belt, fans, pulleys, and flywheel. Contact can cause severe injury.



Do not run the engine without the safety devices in place. Prior to start-up, mount all safety devices securely and check for proper attachment and function.

### 1.5.9 Anti-freeze and disposal of fluids

Anti-freeze contains toxic substances. To prevent injury, wear rubber gloves and wash off any anti-freeze immediately in case of skin contact. Do not mix different anti-freeze agents. The mixture may cause a chemical reaction generating harmful substances. Use only anti-freeze that was approved by Fischer Panda.



Protect the environment. Collect drained fluids (lubricants, anti-freeze, fuel), and dispose of them properly. Observe the local regulations for the respective country. Ensure that no fluids (not even very small quantities) can drain into the soil, sewers, or bodies of water.



### 1.5.10 Implementation of safety inspections and maintenance

---

Disconnect the battery from the engine before performing service work. Affix a sign to the control panel - both the main and the corresponding slave panel - with the instruction "DO NOT START UP - MAINTENANCE IN PROGRESS" to prevent unintentional start-up.



To prevent sparking due to accidental short-circuiting, always remove the earthing cable (-) first and reconnect it last. Do not start work until the generator and all fluids and exhaust system parts have cooled down.

Use only suitable tooling and appliances and familiarise yourself with their functions to prevent secondary damage and/or injury.



Always keep a fire extinguisher and a first aid box handy while performing maintenance work.

## 1.6 Warning and instruction signs

---

Keep warning and instruction signs clean and legible.

Clean the signs with water and soap and dry them with a soft cloth.

Immediately replace damaged or missing warning and instruction signs. This also applies to the installation of spare parts.

### 1.6.1 Special instructions and hazards of generators

---

The electrical installations may only be carried out by trained and qualified personnel!



**The generator must not be operated with the cover removed.**

If the generator is being installed without a sound insulation capsule, it must be ensured that all rotating parts (belt-pulley, belts etc.) are covered and protected so that there is no danger to life and body!



If a sound insulation covering will be produced at the place of installation, then easily visible signs must show that the generator must only be switched on while the capsule is closed.

All servicing, maintenance, or repair work may only be carried out when the motor is not running.



Electrical voltages above 48 volts (battery chargers greater than 36 volts) are always dangerous to life. The rules of the respective regional authority must be adhered to during installation. For safety reasons, only an electrician may carry out the installation of the electrical connections of the generator.



### 1.6.1.1 Protective conductor and potential equalisation:

Electric current below 48 V may be life-threatening. For this reason systems are grounded with a protective conductor. In connection with a RCD the current supply will be disconnected in case of a failure.

Appropriate safety precautions like the RCD and corresponding fuses have to be provided by the customer to guarantee a safe operation of the generator.

### 1.6.1.2 Protective conductor for Panda AC generators:

The generator is „earthed“ as a standard (centre and ground are interconnected in the generator terminal box by a shunt). This is a basic first-level safety measure, which offers protection as long as no other measures are installed. Above all, it is designed for delivery and a possible test run.

This „neutralisation“ (Protective Earthing Neutral - PEN) is only effective if all parts of the electrical system are jointly „earthed“ to a common potential. The shunt can be removed if this is necessary for technical reasons and another protective system has been set up instead.

**While the generator is being operated, the full voltage is applied to the AC control box, as well. Therefore, it is essential to ensure that the control box is closed and secured against touch while the generator is running.**

**The battery must always be disconnected if work on the generator or electrical system is to be carried out, so that the generator cannot be started up unintentionally.**



### 1.6.1.3 Switch off all loads while working on the generator

All loads must be disconnected prior to working on the generator to avoid damage to the devices. In addition, the semiconductor relays in the AC control box must be disconnected in order to avoid the booster capacitors being activated during set-up. The negative terminal of the battery must be disconnected.

Capacitors are required to run the generator. These have two varying functions:

- A) The working capacitors
- B) The booster capacitors

Both groups are located in a separate AC control box.

Capacitors store electrical energy. High voltages may remain across the capacitor contacts even after they have been disconnected from the mains. As a safety precaution, do not touch the contacts. If the capacitors must be replaced or inspected, the contacts shall be short-circuited by connecting an electrical conductor to discharge potentially remaining potential differences.

If the generator is switched off normally, the working capacitors are automatically discharged via the winding of the generator. The booster capacitors are discharged by means of internal discharge resistors.

For safety reasons, all capacitors must be discharged through short-circuiting before work is carried out on the AC control box.

### 1.6.1.4 Potential equalisation for Panda AGT DC generators

For further information specific to your generator, see the chapter installation.

### 1.6.1.5 Safety instructions concerning cables

#### Cable types

It is recommended to use cables that are in compliance with the standard UL 1426 (BC-5W2) with type 3 (ABYC section E-11).

#### Cable cross-section

The cable shall be selected taking into account the amperage, cable type, and conductor length (from the positive power source connection to the electrical device and back to the negative power source connection).

#### Cable installation

It is recommended to install a self-draining cable conduit classified as V-2 or higher in compliance with UL 94 in the area of the cable guide inside the capsule. It must be ensured that the cable guide is not routed along hot surfaces such as the exhaust manifold or the engine oil drain screw but instead is installed free from any influence due to friction and crushing.

### 1.6.2 Recommended starter battery sizes

---

Use only batteries approved by the manufacturer as starter batteries.

Use the battery capacity recommended by the engine manufacturer.

#### ATTENTION!

Prior to installation, verify that the voltage of the starter battery complies with the start-up system voltage.

e.g. 12 V starter battery for 12 V start-up system

e.g. 24 V starter battery for 24 V start-up system (e. g. 2x 12 V in series)



### 1.6.3 Important instructions for batteries - starter and/or traction batteries

---

#### ATTENTION!!! Start-up:

Installation of battery connection lines.

Observe the instructions installation guidelines of the battery manufacturer.



Observe the regulations "ABYC regulation E11 AC and DC electrical systems on boats", as EN ISO 10133:2000 "Small craft -- Electrical systems -- Extra-low-voltage DC installations", as applicable!

**The battery compartment and the corresponding installation shall be dimensioned adequately.**



The batteries can be separated mechanically or with an adequate power relay.





Observe the applicable instructions concerning fire and explosion protection of the battery manufacturer.

Install a fuse of appropriate size in the positive connection of the starter battery. Install as close to the battery as possible but with a max. distance of 300 mm (12 in) from the battery.

The cable from the battery to the fuse shall be protected with a conduit/protective sleeve against fraying.

Use self-extinguishing and fire-protected cables for installation that are designed for max. temperatures of 90 °C, 195 °F.

Install the battery cables in such a way that the insulation cannot be removed by chafing or other mechanical stresses.

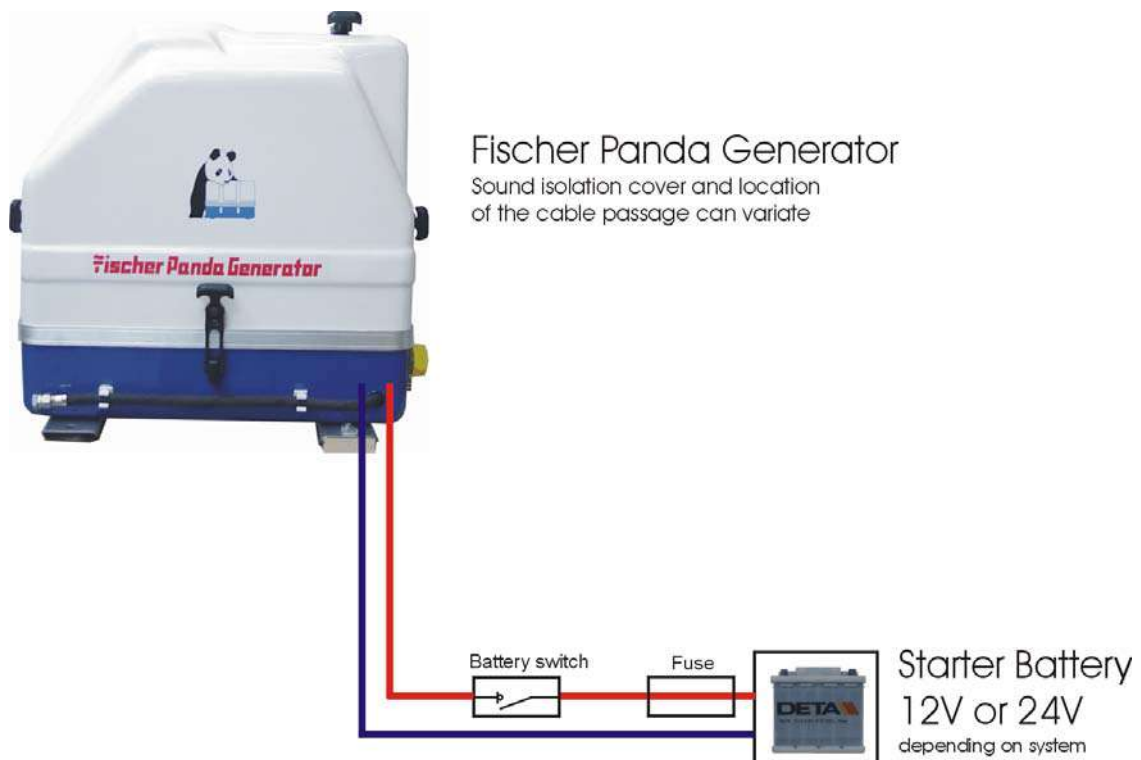
The battery terminals must be protected against accidental short-circuiting.

Inside the Fischer Panda generator capsule, the positive battery cable must be routed so that it is protected from heat and vibrations by means of an adequate conduit/protective sleeve. It must be installed so that it does not come into contact with rotating parts or such that heat up during operation such as pulley, exhaust manifold, exhaust pipe, and motor itself. Do not overtighten the cable, as it may be damaged otherwise.

After completing the installation, perform a test run of the generator and check the battery cable installation during and after the test run. Implement corrections as necessary.



Fig. 1.6-1: Sample diagram for starter battery installation



## 1.6.4 General safety instructions for handling batteries

**These instructions shall apply in addition to the instructions of the battery manufacturer:**

- While you are working on the batteries, a second person should be within earshot to help you if necessary.
- Keep water and soap ready in case battery acid is burning your skin.
- Wear eye protection and protective clothing. Do not touch your eyes while handling batteries.






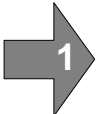
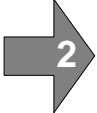
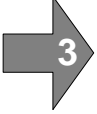
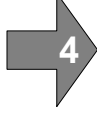
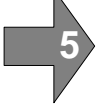
- If you have acid splashes on the skin or clothing, wash them out with lots of water and soap.
- If acid sprays into your eyes, immediately flush them with clean water until no more burning is felt. Immediately seek medical assistance.
- Do not smoke near the batteries. Avoid naked fire. The area around batteries is a potentially explosive atmosphere.
- Ensure that no tools are dropped on the battery terminals; cover them as necessary.
- Do not wear jewellery or watches on your arms during installation that might short-circuit the battery. Otherwise, there is a risk of skin burns.
- Protect all battery contacts against accidental contact.
- For battery banks: Use only deep cycle batteries. Starter batteries are not suitable. Lead-acid gel batteries are recommended. They are maintenance-free, cycle stable, and do not release gases.
- Never charge a frozen battery.
- Avoid battery short-circuits.
- Ensure proper ventilation of the battery to vent gases that may be released.
- Battery connection terminals must be checked for proper seating before operation.
- Battery connection cables shall be installed with utmost care and shall be checked for excessive heating under load. Check the battery near vibrating components regularly for chafing and insulation defects.



**ATTENTION! For battery charger generators (Fischer Panda AGT-DC)!**

**Prior to installation, verify that the voltage of the battery bank complies with the output voltage of the generator.**

## 2. In case of Emergency First Aid / Im Notfall - Erste Hilfe

		
	<p>First Aid in case of accidents by electrical shocks</p> <p>5 Safety steps to follow if someone is the victim of electrical shock</p>	
	Do not touch the injured person while the generator is running.	
	Switch off the generator immediately.	
	If you cannot switch off the generator, pull, push, or lift the person to safety using a wooden pole, rope or some nonconducting material.	
	Call an emergency doctor as soon as possible.	
	Immediately start necessary first aid procedures.	

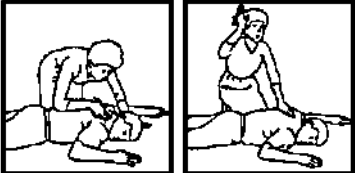

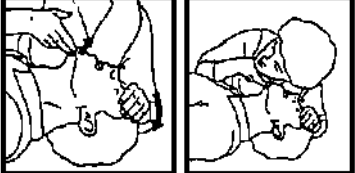





## 2.1 WHEN AN ADULT STOPS BREATHING

**DO NOT attempt to perform the rescue breathing techniques provided on this page, unless certified. Performance of these techniques by uncertified personnel could result in further injury or death to the victim.**

Warning:



<p><b>1</b> Does the Person Respond? Tap or gently shake victim. Shout, "Are you OK?"</p>		<p><b>2</b> Shout, "Help!" Call people who can phone for help.</p>
<p><b>3</b> Roll Person onto Back. Roll victim towards you by pulling slowly.</p>		
<p><b>4</b> Open Airway. Tilt head back, and lift chin. Shout, "Are you OK?"</p>		<p><b>5</b> Check for Breathing. Look, listen, and feel for breathing for 3 to 5 seconds.</p>
<p><b>6</b> Give 2 Full Breaths. Keep head tilted back. Pinch nose shut. Seal your lips tight around victim's mouth. Give 2 full breaths for 1 to 1½ seconds each.</p>		
<p><b>7</b> Check for Pulse at side of Neck. Feel for pulse for 5 to 10 seconds.</p>		<p><b>8</b> Phone EMS for Help. Send someone to call an ambulance.</p>
<p><b>9</b> Begin Rescue Breathing. Keep head tilted back. Lift chin. Pinch nose shut. Give 1 full breath every 5 seconds. Look, listen, and feel for breathing between breaths.</p>		<p><b>10</b> Recheck Pulse Every Minute. Keep head tilted back. Feel for pulse for 5 to 10 seconds. If victim has pulse, not breathing, continue rescue breathing. If no pulse, begin CPR.</p>

## 3. Basics

### 3.1 Intended use of the machine

---

---

The Fischer Panda generator is made to produce electrical energy out of diesel fuel.

The diesel fuel is converted to mechanical energy by the diesel engine. This mechanical energy drives the generator. In the genset, the mechanical energy is converted to electrical energy. This process is controlled by (sometimes external) components, the remote control panel and the voltage control system (VCS).

For the process is a sufficient amount of fuel and combustion air necessary. Arising exhaust and heat must be lead away.

If the electrical power should be applied to a local net, The regulation and installation instructions of the Net owner and the regional authorities must be respected. This includes lightning conductor, personal protection switch etc.

Misapplication of the Product can damage and destroy the product and the electrical net inclusive all load which is attached to the net, and contain hazards like short circuit. It is not allowed to modify the product in any case. Never open the sound cover during operation. The safety and hazard notes of the manual must be respected.

#### 3.1.1 Purpose of the manual and description of the definitions trained person/operator/user

---

This manual is work instruction and operation instruction for the owner and user of Fischer Panda generators.

The manual is the base and the guideline for the correct installation and maintenance of Fischer Panda Generators.

The manual does not substitute the technical evaluation and should be used as an example guide only.

The installation must be undertaken and proved by a suitable qualified/trained person and may in accordance with the law as required by the country and special situation.

##### 3.1.1.1 Trained persons

**Trained persons for the mechanical components are motor mechanics or persons with similar education and training.**

**Trained persons for the electrical components are electricians or persons with similar education and training.**

**After the Installation, the trained person must instruct the owner for operation and maintenance of the generator. This must include the hazards of the generator use.**

#### 3.1.2 Operator

---

**The operator is the for the operation of the generator responsible person.**

After the installation, the operator must be instructed for the operation ad maintenance of the generator. This must include the hazards during operation of the generator and a instruction for the maintenance.

The operator must read and follow the manual and must respect the hazard notes and safety instructions.

##### 3.1.2.1 User

**Users are persons, established by the operator, to operate the generator.**

The operator must assure that the user read and understand the manual and that all hazard notes and safety instructions are respected. The user must be instructed by the operator regarding his activity at the generator.



## 3.2 Panda Transport Box

---

### 3.2.1 Bolted Fischer Panda Transport Box

---

1. Remove the bolts for cover / sidewalls
2. Remove the cover
3. Remove the loose accessories
4. Remove the bolts for sidewalls / floor pallet
5. Remove the sidewalls
6. Open the generator attachment

### 3.2.2 Fischer Panda Transport Box with metal tab closure

---

1. Bend up the metal tab closures on the transport box lid.
2. Remove the cover
3. Remove the loose
4. Bend open the metal tab closures on the transport box bottom.
5. Remove the sidewalls
6. Open the generator attachment

## 3.3 Transport and Loading/Unloading

---

### 3.3.1 Transporting the generator

---

- The generator must always be upright for transport.
- For transport, the Fischer Panda Transport Box shall be used for the generator. The generator shall be securely attached to the bottom of the box.
- For loading/unloading, an adequate industrial truck shall be used.
- Depending on the transport distance (e.g. air cargo), the generator fluids (coolant, engine oil, fuel) may have to be drained. The corresponding instructions and warnings must be fitted to the transport packaging.

### 3.3.2 Loading/unloading of the generator

---

For loading/unloading the generator, appropriate ring eye bolts shall be installed in the holes in the support rails. The load bearing capacity of each ring eye bolt must at least equal the generator weight.



An adequate lifting yoke shall be used for transport/loading

Fig. 3.3-1: Lifting yoke (example)



## 3.4 Scope of delivery

The Fischer Panda PMS generator system contains following components:

### 3.4.1 Asynchronous Generator:

#### Fischer Panda Generator

representative picture

Fig. 3.4-1: Fischer Panda Generator



#### Remote control panel

representative picture

Fig. 3.4-2: Remote control panel



### AC Control Box

The AC Control Box contains the capacitors and the control circuit board (VCS) for the generator.

At ND generators and generators with mini VCS the capacitors and the VCS may be mounted at the generator. The AC Control Box is not required for these generators.

representative picture

Fig. 3.4-3: AC Control Box



### Fischer Panda Manual

The Fischer Panda Manual contains the following components:

- Clear foil bag with general information etc.
- Generator manual with added remote control panel manual
- Spare part catalogue „Installation & Service Guide“
- Engine manual from the engine manufacturer.
- Wiring diagram for the generator

representative picture

Fig. 3.4.1-4: Fischer Panda Manual



### Optionales components f.e.:

- Fuel pump
- Installation kit
- Water lock
- ect.





## 3.4.2 Opening the MPL sound insulation capsule

To open the sound insulation capsule, the closures must be rotated roughly 180° counter-clockwise. Use a flat head screwdriver. Pull the sidewalls out by gripping into the slots.



Closure locked

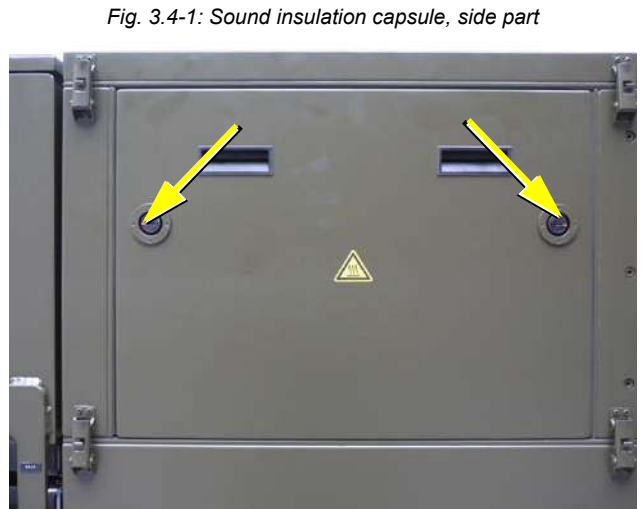


Fig. 3.4-1: Sound insulation capsule, side part

Fig. 3.4.2-2: Closure locked



Closure open

Fig. 3.4-3: Closure open



## 3.4.3 Opening the GFK sound insulation capsule

## GFK sound insulation capsule with lash closures

Fig. 3.4-1: Lash closures



To open the lash closures pull the handle in arrow direction and lift the lash of the closure pin. After lifting of the lashes, the sound isolation cover upper parts can be removed.

Fig. 3.4-2: Lash closures



## 3.5 Special maintenance notes and arrangements at long periods of stand still time or shutdown

Stand still is divided into the following groups:

- Short-term standstill (1 to 3 months).
- Medium-term standstill / winter storage (3 to 6 months).
- Long-term standstill (storage) / shutdown (more than 6 months).

### 3.5.1 Reference note for the starter battery at a long-term standstill

#### Starter batteries

Self-discharge of batteries is a physical and chemical process and cannot even be avoided by disconnecting the battery.

- Disconnect the battery from the generator at a long-term standstill.
- Charge the battery on a regular basis. Follow the notes of the battery manufacturer.

Before charging the battery, check the acid level according to the type of battery and refill each cell with distilled water up to the marking if necessary.

Today's starter batteries are normally maintenance-free.

#### Notice:



### **Deep discharge may damage the battery and may be useless afterwards.**

Keep the battery clean and dry. Continuously clean the battery terminals (+ and -) and clamps and lubricate with an acid-free and acid-resistant grease. Make sure there is a good contact of the clamp connections when assembling. If voltage is approx. below 1,95 Volt, the cell should not decline the open-circuit voltage of the battery. This equates approx. 2,1V / cell open-circuit voltage when battery is fully charged.

For a 12 V battery applies 11,7 V lower open-circuit voltage (battery flat) - conservation charging 13,2 V.

For a 24 V battery applies 23,4 V lower open-circuit voltage (battery flat) - conservation charging 26,4 V.

*These data relate to a battery temperature of 20-25°C. Consider the specifications of the battery manufacturer.*

#### **Fischer Panda recommendation:**

- Install a battery main switch and turn it to the off-position. (Disrupt the battery circuit)
- Install a sufficient fuse in the positive battery line close to the battery
- Check contacts for corrosion on a regular basis.

#### **Notice:**



### **3.5.2 Arrangements at a short-term standstill**

---

Short-term standstill (1 to 3 months)

- Measure the charge of battery via the open-circuit voltage
- At stand still >7 days - disconnect the battery (e.g. put battery main switch to 0)
- Within 2-3 months - let the engine run for at least 10 min
- Fill fuel tank to 100% (level to full).

### **3.5.3 Arrangements at a medium-term standstill / winter storage**

---

Medium-term stand still (3 to 6 months)

#### **3.5.3.1 Arrangements for conservation:**

- Check the charge of battery and recharge approximately every 3 months if necessary. Consider the specifications of the battery manufacturer.
- Check anti-freeze protection of the cooling water and refill if applicable.

The anti-freeze protection should not be older than 2 years. The content of the anti-freeze protection should be between 40% and 60% to ensure corrosion protection in the cooling water circuit; Refill anti-freeze if necessary.

If cooling water will be drained, for example after a conservation of the engine, no water should remain within the engine during the stand still. At the control unit a correspondent note „NO COOLING WATER“ has to be placed.

- Drain engine oil as required. Refill engine with conservation oil up to maximum at the oil dip stick.
- Drain diesel fuel from tank and refill with conservation mixture (90% diesel and 10% conservation oil - up to max).

#### **Let engine run for 10 min.**

- Remove v-belt as required and store packed at a dry place. Protect from UV radiation.

#### **Cover alternator openings.**

#### **Attention!**

No cleaning fluids or preserving agents may enter the alternator. Danger to destroy the alternator.



- Clean engine according to the manufacturer.
- Inject engine parts and v-belt pulleys with a preserving agent.
- Clean air filter housing and inject with a preserving agent.
- Close suction hole and exhaust opening (e.g. with tape or end caps).
- Drain sea water circuit.
- Close sea cock.
- Clean sea water filter.
- Remove impeller and store.

**Carry out a deconservation before recommissioning.**

**Attention!**



### **3.5.3.2 Arrangements for deconservation after a medium-term standstill (3 to 6 months).**

- Check charge of battery and recharge if necessary. Consider the specifications of the battery manufacturer.
- Check anti-freeze protection of the cooling water and refill if applicable.
- Drain engine oil. Renew oil filter and oil according to specification.
- Remove preservation agent of the engine with petroleum.
- Degrease the v-belt pulleys and install v-belt correctly. Check v-belt tension!
- Disconnect turbocharger oil pressure line if existent and refill clean motor oil in pipe.
- Keep engine shut-off lever in 0-position and turn engine several times by hand.
- Clean air filter housing with petroleum, check air filter and renew if necessary.
- Remove covers of the exhaust opening and the suction holes.
- Connect battery. Close battery main switch.
- Install impeller.
- Open sea cock.
- Check sea water filter.
- Keep shut-off lever at generator in 0-position and activate starter for approx. 10 sec. Make a break for 10 sec. and repeat procedure twice.
- Visual inspection of the generator according to initial operation and start generator.

### **3.5.4 Arrangements at a long-term standstill / shutdown**

---

Standstill (more than 6 months)

#### **3.5.4.1 Arrangements for conservation:**

- Check the charge of battery and recharge approximately every 3 months if necessary. Consider the specifications of the battery manufacturer.
- Check anti-freeze protection of the cooling water and refill if applicable.

The anti-freeze protection should not be older than 2 years. The content of the anti-freeze protection should be between 40% and 60% to ensure corrosion protection in the cooling water circuit; Refill anti-freeze if necessary.

If cooling water will be drained, for example after a conservation of the engine, no water should remain within the



engine during the stand still. At the control unit a correspondent note „NO COOLING WATER“ has to be placed.

- Drain engine oil as required. Refill engine with conservation oil up to maximum at the oil dip stick.
- Drain diesel fuel from tank and refill with conservation mixture (90% diesel and 10% conservation oil - up to max).

#### **Let engine run for 10 min.**

- Remove v-belt as required and store packed at a dry place. Protect from UV radiation
- Disconnect battery. Sprinkle terminals with acid-free grease.

#### **Cover alternator openings.**

#### **Attention!**

No cleaning fluids or preservative agents may enter the alternator. Danger to destroy the alternator.



- Clean engine according to the manufacturer.
- Inject engine parts and v-belt pulleys with a preserving agent.
- Clean air filter housing and inject with a preserving agent.
- Sprinkle exhaust turbo charger (if existent) with conservation agent at intake and exhaust and close lines again. Sprinkle preserving agent to the intake and exhaust lines than attach again.
- Remove valve cover and sprinkle the inside of the cover, shafts, springs, rocker lever etc. with preserving agent.
- Remove injectors and sprinkle the cylinder area with preserving agent. Keep the shut-off lever on the 0-position and turn the engine by hand for several times. Screw in the injectors with new gaskets. Consider the torsional moments.
- Sprinkle slightly the radiator cap and tank lid and respectively the radiator cap at the expansion tank and reinstall.
- Close intake and exhaust openings (for example with tape or end caps).
- Drain sea water circuit.
- Close sea cock.
- Clean sea water filter.
- Dismount impeller and store.

#### **Carry out a de-conservation before recommissioning.**

#### **Attention!**



### **3.5.4.2 Arrangements after a long-term standstill (shutdown) / recommissioning (more than 6 months):**

- Check the charge of battery and recharge if necessary. Consider the specifications of the battery manufacturer.
- Check anti-freeze protection and level of the cooling water and refill if applicable.
- Drain engine oil. Renew oil filter and oil according specification.
- Remove preservation agent of the engine with petroleum.
- Degrease the v-belt pulleys and install v-belt correctly. Check v-belt tension!
- Disconnect turbocharger oil pressure line if existent and refill clean motor oil in pipe.
- Keep engine shut-off lever in 0-position and turn engine several times by hand.
- Clean air filter housing with petroleum, check air filter and renew if necessary.
- Remove covers of the exhaust opening and the suction holes.
- Connect battery. Close battery main switch.
- Install impeller.

- Open sea cock.
- Check sea water filter.
- Keep shut-off lever at generator in 0-position and activate starter for approx. 10 sec. Make a break for 10 sec. and repeat procedure twice.
- Visual inspection of the generator according to initial operation and start generator.

**Fischer Panda recommendation:**

After a long-term standstill a complete 150 h inspection according to inspection schedule should be carried out.

**Notice:**

## 4. The Panda Generator

### 4.1 Position of Identification plate

Fig. 4.1-1: Position of identification plate

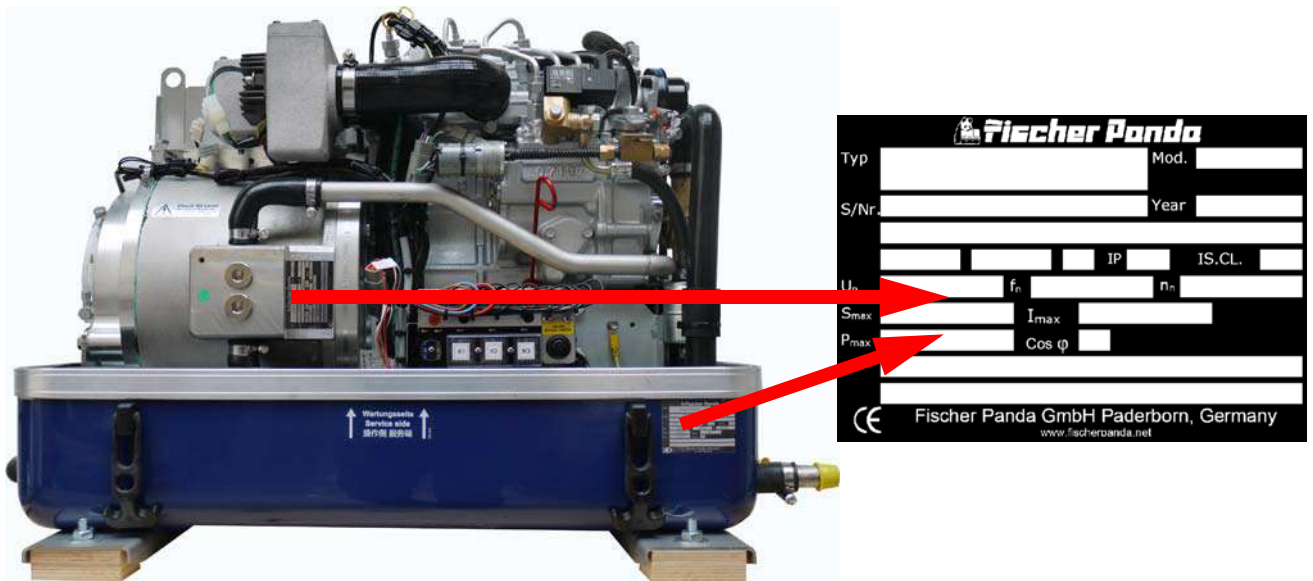
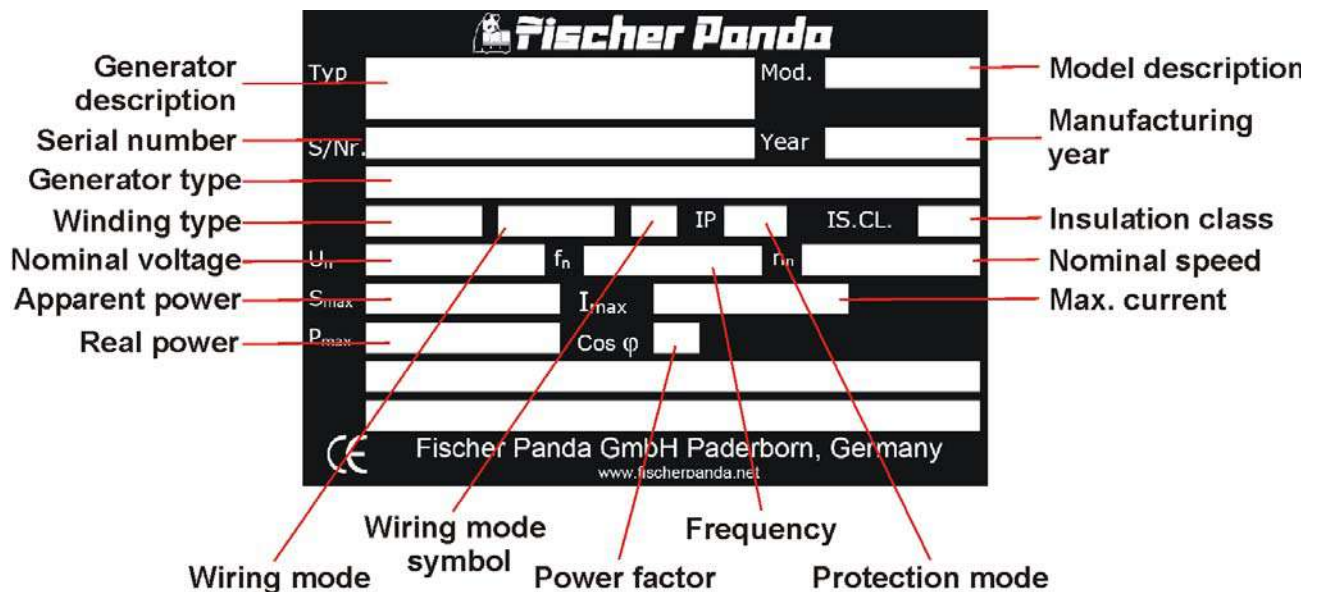


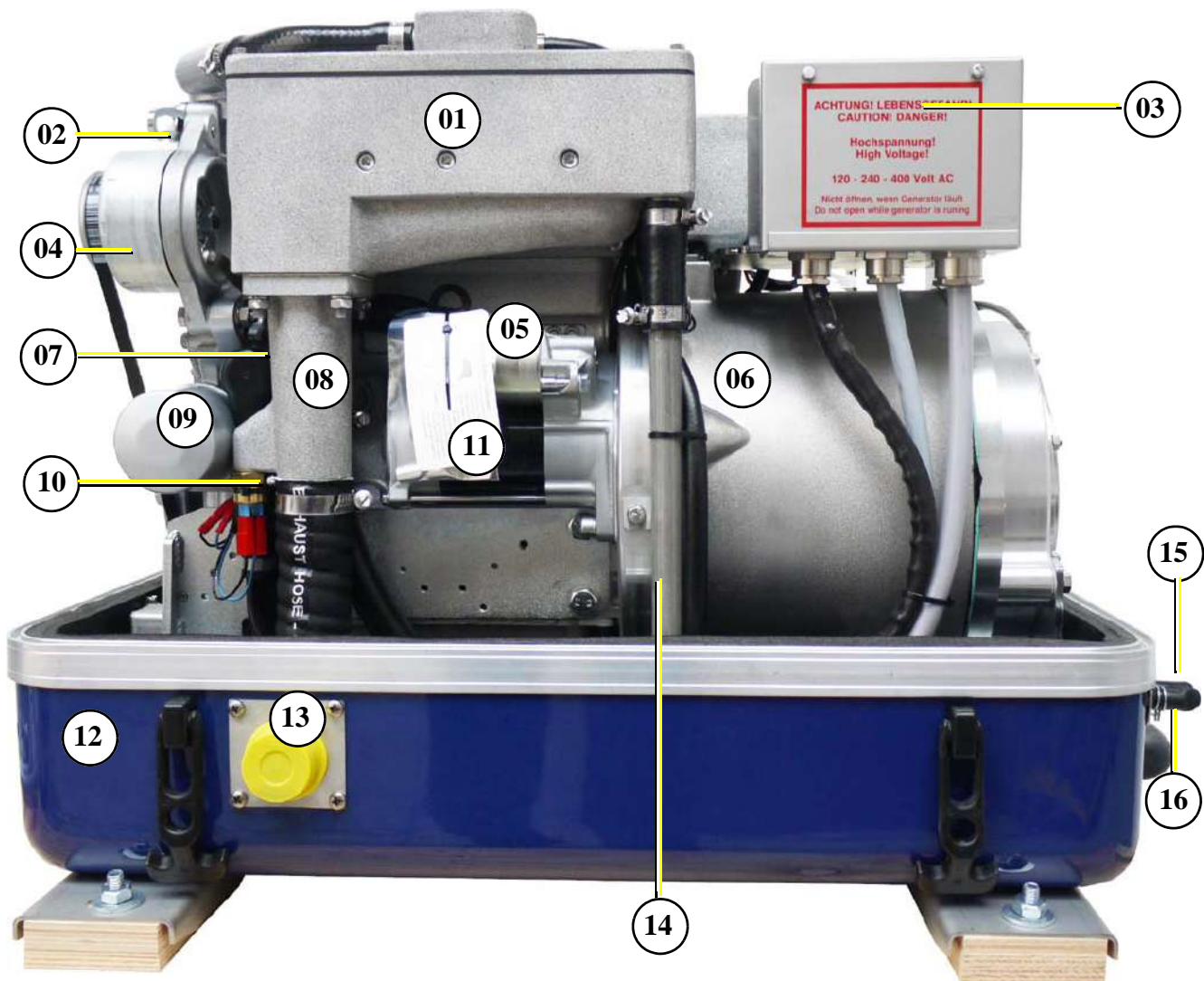
Fig. 4.1-2: Identification plate description



## 4.2 Description of the Generator

### 4.2.1 Generator side view RH

Fig. 4.2.1-1: Generator side view RH

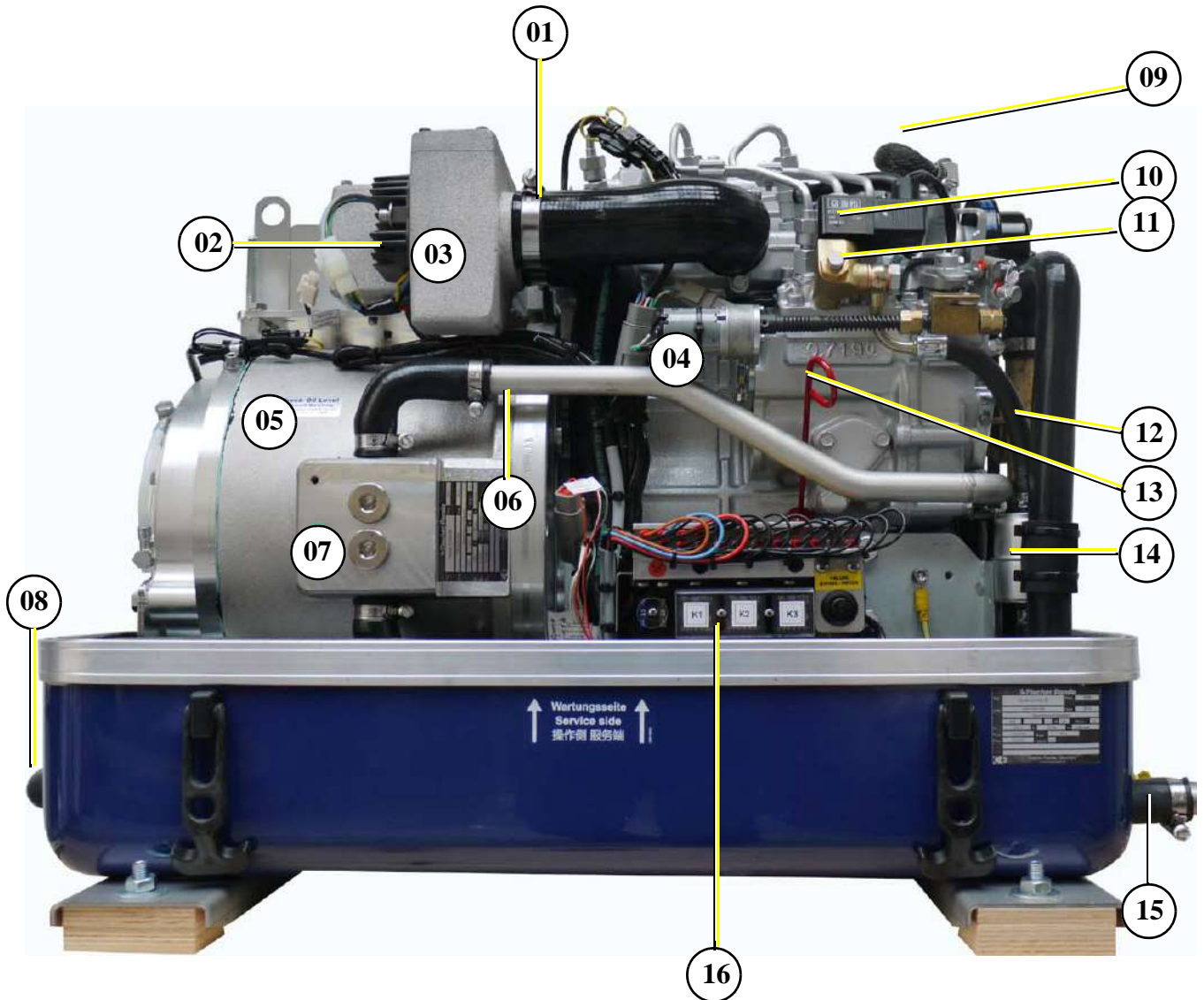


- |     |   |     |   |
|-----|---|-----|---|
| 01. | Water-cooled exhaust manifold                   | 09. | Engine oil filter                               |
| 02. | 12 V <sub>DC</sub> -alternator                  | 10. | Thermo-switch exhaust connection                |
| 03. | Generator power terminal box                    | 11. | Starter motor                                   |
| 04. | V-belt for DC-alternator and cooling water pump | 12. | Sound insulation capsule - base part            |
| 05. | Magnetic switch for starter motor               | 13. | Exhaust hose connection                         |
| 06. | Generator housing with coil                     | 14. | Cooling water return pipe                       |
| 07. | Oil pressure switch                             | 15. | Intake external cooling water expansion tank    |
| 08. | Exhaust connection                              | 16. | Back flow external cooling water expansion tank |



## 4.2.2 Generator side view LH

Fig. 4.2.2-1: Generator side view LH

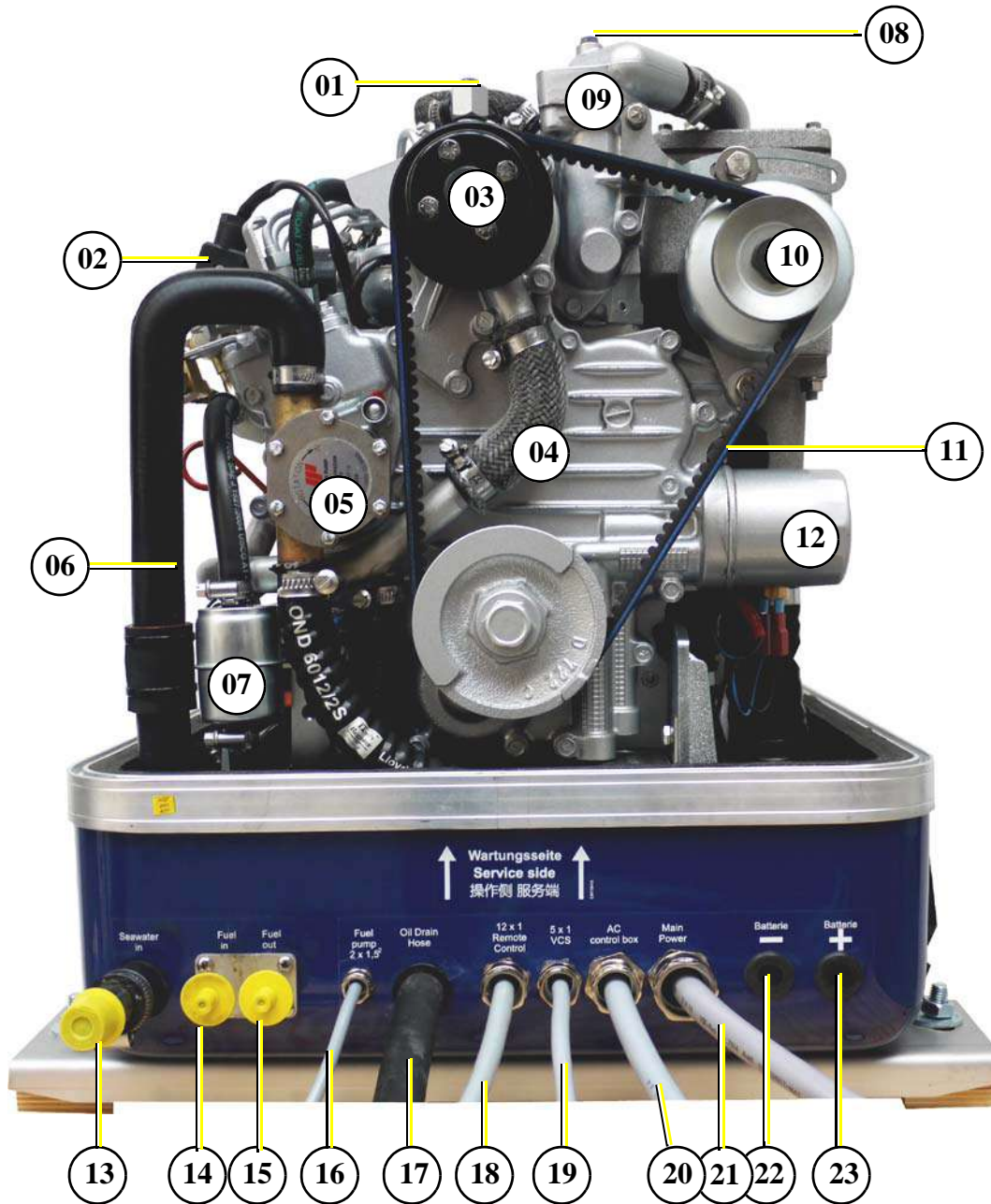


- |     |   |     |                                       |
|-----|---|-----|---------------------------------------|
| 01. | Thermo-switch cylinder head                               | 09. | Ventilation screw thermostat housing  |
| 02. | Charge control for DC-alternator                          | 10. | Fuel solenoid valve                   |
| 03. | Air suction housing with air filter                       | 11. | Ventilation screw fuel solenoid valve |
| 04. | Actuator for speed control                                | 12. | Raw water pump                        |
| 05. | Generator housing with coil                               | 13. | Oil dipstick                          |
| 06. | Cooling water pipe, connection block - cooling water pump | 14. | Fuel filter                           |
| 07. | Cooling water connection block                            | 15. | Raw water inlet                       |
| 08. | Connection external vent valve                            | 16. | DC terminal with fuses and relays     |



### 4.2.3 Generator front view

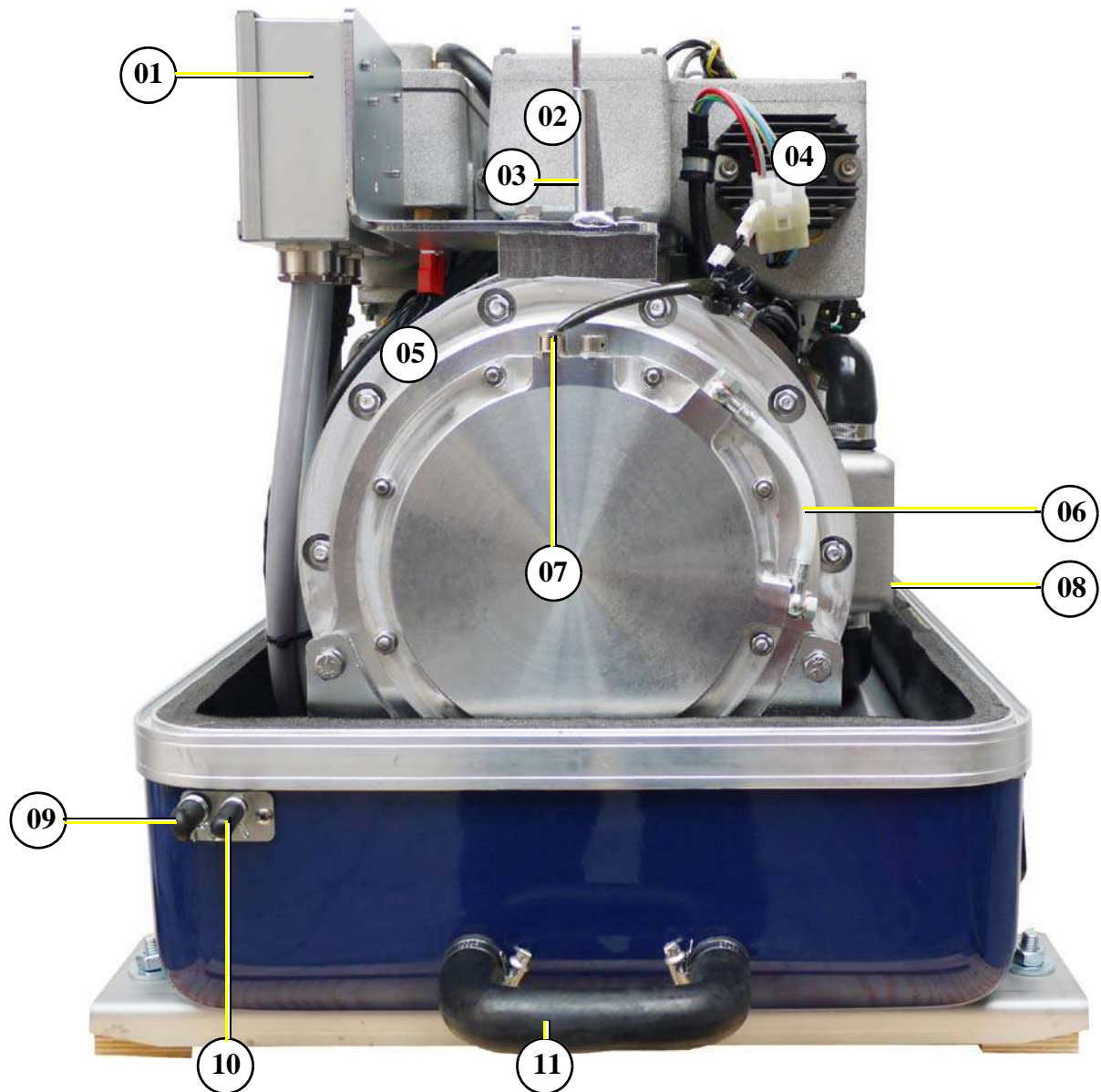
Fig. 4.2.3-1: Generator front view



- |  |  |
|--|--|
| 01. Ventilation screw internal cooling water pump            | 13. Raw water inlet  |
| 02. Fuel solenoid valve                                      | 14. Fuel intake connection                                     |
| 03. Pulley for internal cooling water pump                   | 15. Fuel back flow connection                                  |
| 04. Freshwater intake pipe                                   | 16. Fuel pump cable (2x1,5mm <sup>2</sup> )                    |
| 05. Raw water pump   | 17. Oil drain hose   |
| 06. Hose for seawater intake                                 | 18. Remote control panel cable (12x1mm <sup>2</sup> )          |
| 07. Fuel filter  | 19. Electronic Voltage Control cable VCS (5x1mm <sup>2</sup> ) |
| 08. Ventilation screw thermostat housing                     | 20. AC-Control box cable                                       |
| 09. Thermostat housing with thermostat set                   | 21. Load   |
| 10. DC-alternator  | 22. Battery minus (-)  |
| 11. V-belt for DC-alternator and internal cooling water pump | 23. Battery plus (+)   |
| 12. Engine oil filter  |  |

#### 4.2.4 Generator back view

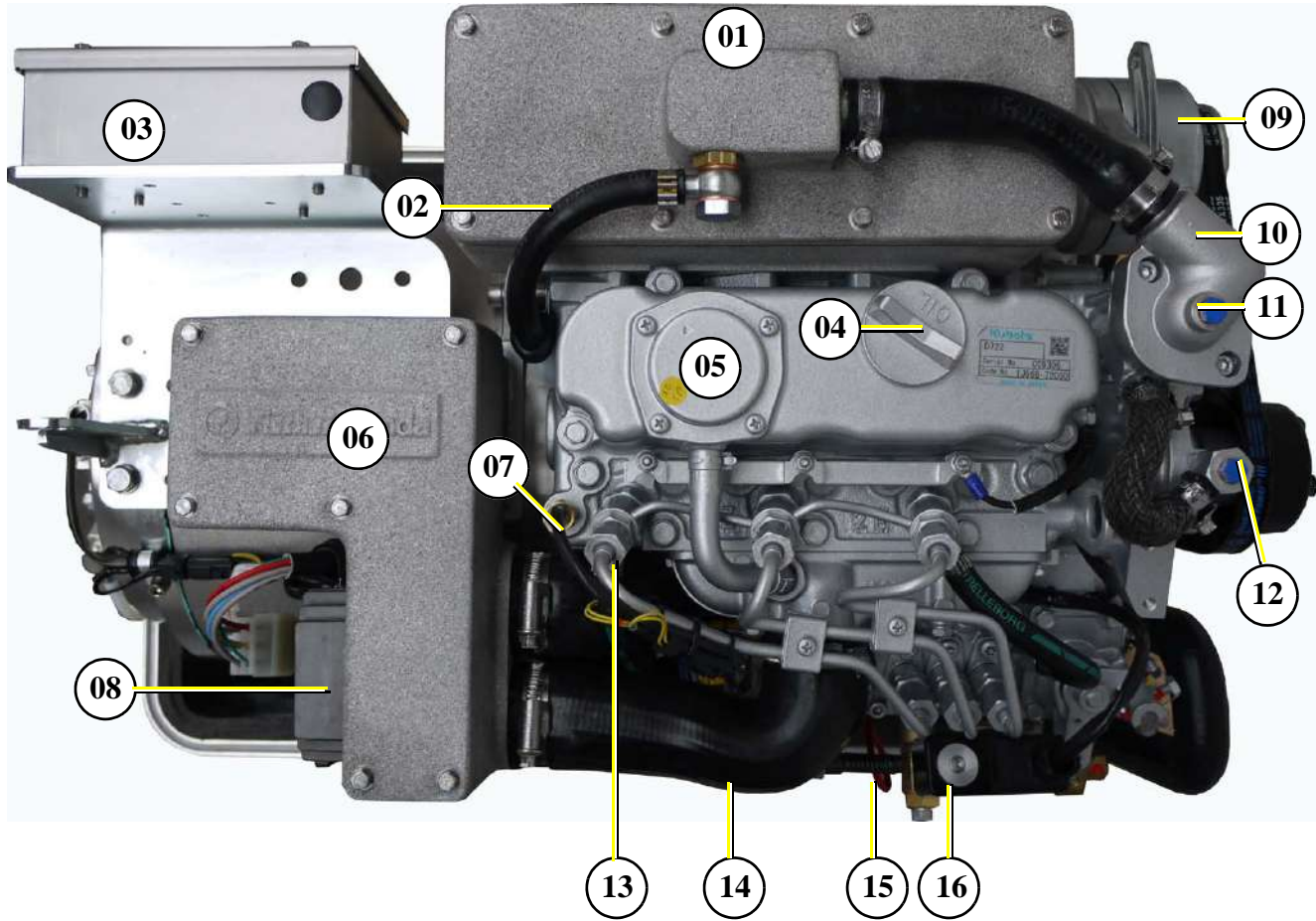
Fig. 4.2.4-1: Generator back view



- |     |                                     |     |   |
|-----|-------------------------------------|-----|---|
| 01. | Power terminal box                  | 07. | Thermo switch at oil cooled bearing             |
| 02. | Air suction housing with air filter | 08. | Cooling water connection block                  |
| 03. | Lifting device                      | 09. | Intake external cooling water expansion tank    |
| 04. | Charge control for DC-alternator    | 10. | Back flow external cooling water expansion tank |
| 05. | Generator front cover               | 11. | External ventilation valve connection           |
| 06. | Oil flow glass                      |     |   |

### 4.2.5 Generator top view

Fig. 4.2.5-1: Generator top view



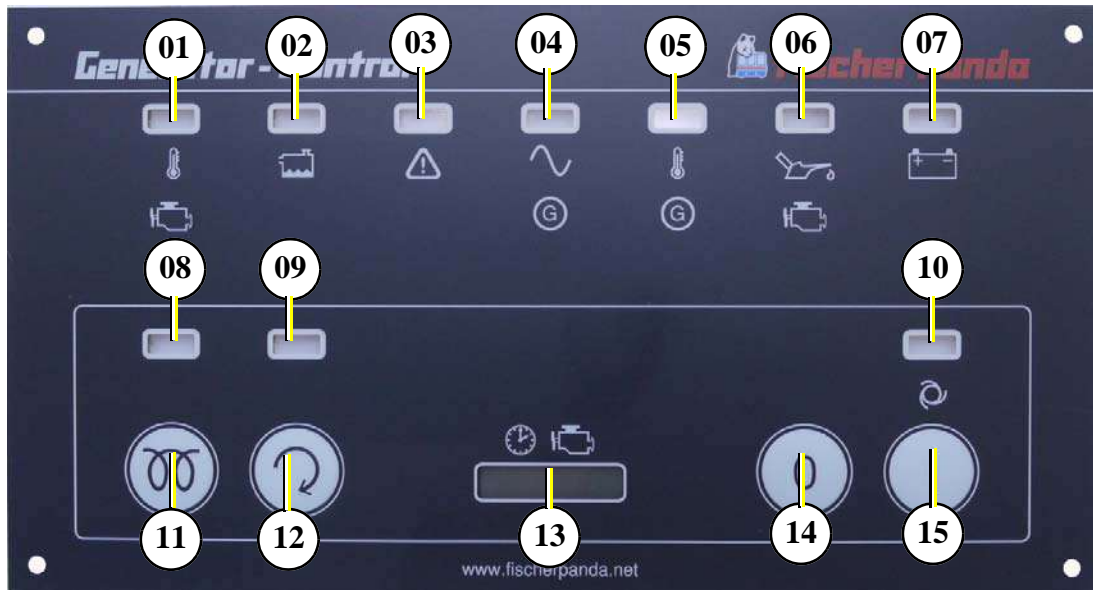
- |   |   |
|---|---|
| 01. Water-cooled exhaust manifold       | 09. DC alternator                                 |
| 02. De aerating hose                    | 10. Thermostat housing with thermostat set        |
| 03. Generator power terminal box        | 11. Ventilation screw thermostat housing          |
| 04. Engine oil filler neck              | 12. Ventilation screw internal cooling water pump |
| 05. Cylinder head                       | 13. Injection nozzle                              |
| 06. Air suction housing with air filter | 14. Air suction hose induction elbow              |
| 07. Cylinder head thermo-switch         | 15. Oil Dipstick                                  |
| 08. Charge control for DC-alternator    | 16. Fuel solenoid valve                           |

## 4.3 Details of functional units

### 4.3.1 Control panel

The control panel is fitted with various monitoring functions, which increase functional reliability and operating safety of the generator. Various parts of the generator are monitored with sensors which, when triggered, generate an error message and can shut down generator operation under certain circumstances to prevent damage.

Fig. 4.3.1-1: Control panel



- 01. LED for cooling water temperature red<sup>1</sup>
- 02. LED for cooling water level red/yellow<sup>1</sup>
- 03. LED for fuel level and air filter replacement red/yellow<sup>1</sup>
- 04. LED for AC voltage ok green<sup>1</sup>
- 05. LED for winding temperature red<sup>1</sup>
- 06. LED for oil pressure red<sup>1</sup>
- 07. Battery loading voltage DC charging light
- 08. LED for pre-heat, „heat“ orange<sup>1</sup>

- 09. LED for generator „start“ green<sup>1</sup>
- 10. LED for generator „stand-by“ green<sup>1</sup>
- 11. Push-button for pre-heat, „heat“
- 12. Push-button for generator „start“
- 13. Operating hours counter
- 14. Push-button panel „off“
- 15. Push-button panel „on“

<sup>1</sup> LED green: normal operating mode, LED red: fault, LED yellow: warning, LED orange: active depending on jumper

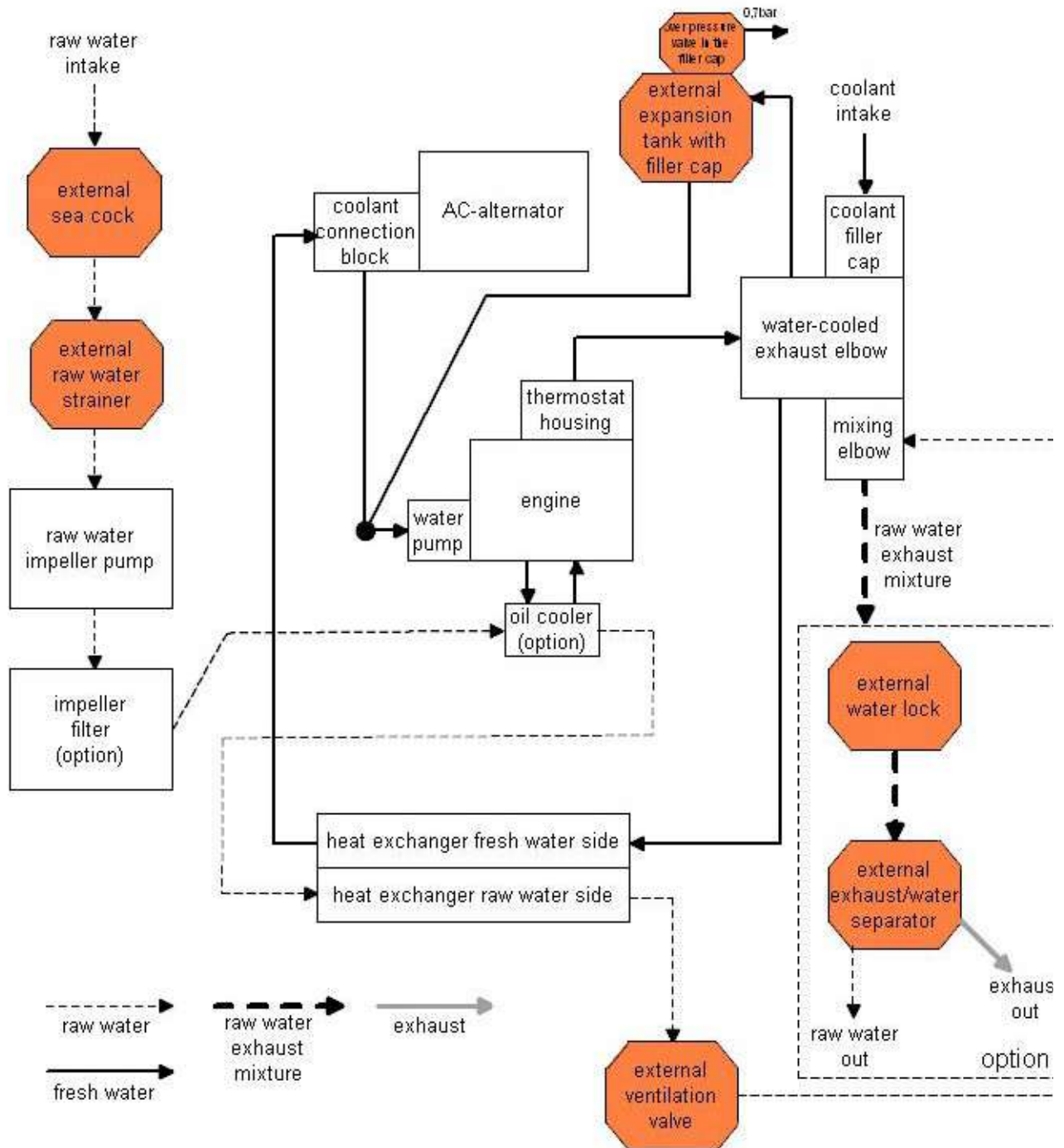
See remote control panel data sheet for details!

Notice!:



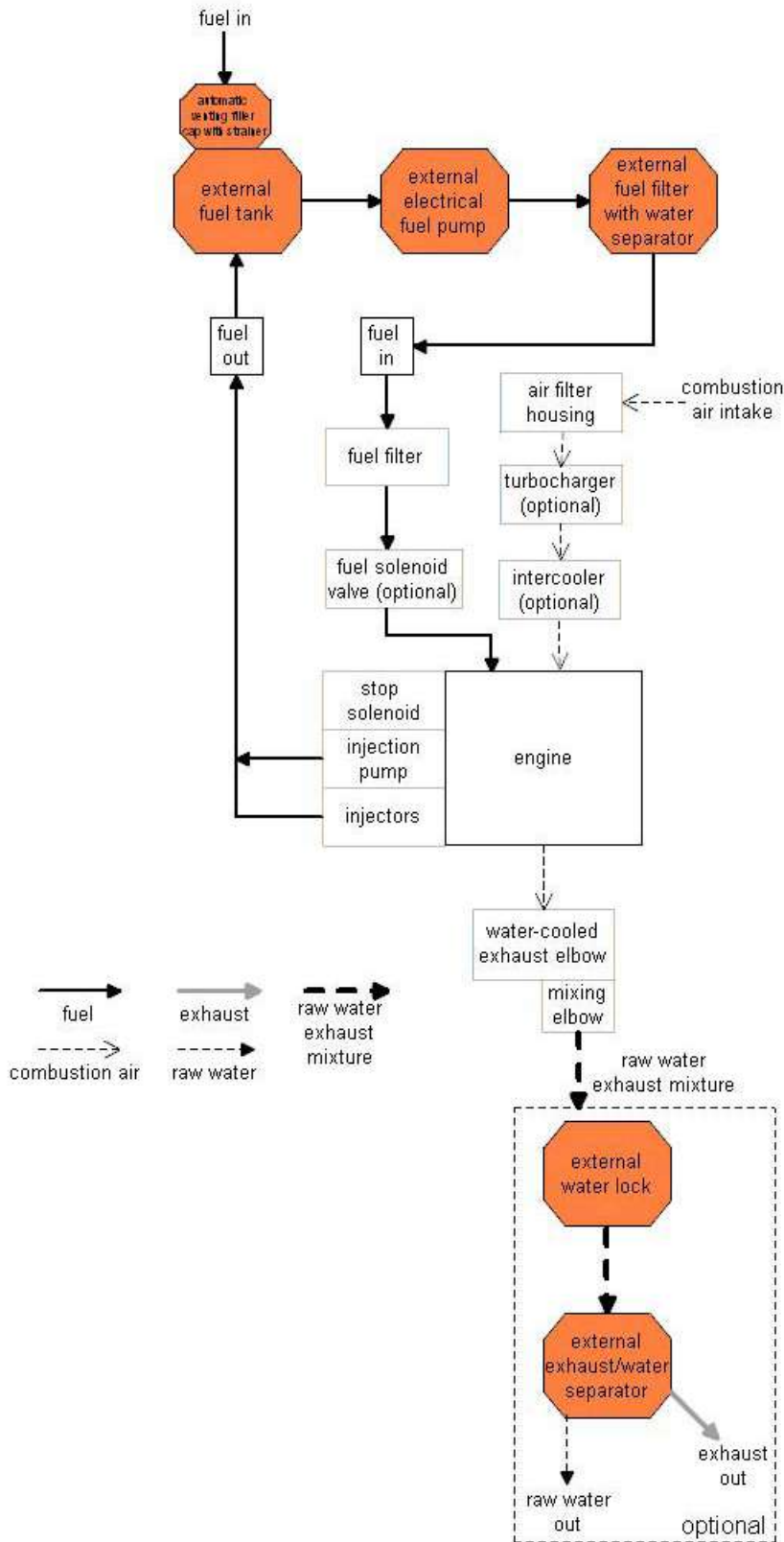
### 4.3.2 The Cooling System - Schema

Fig. 4.3.2-1: The Cooling System - Schema



### 4.3.3 The Fuel System - Schema

Fig. 4.3.3-1: The Fuel System - Schema



#### 4.3.4 The operation surveillance system

##### Thermo-switch at cylinder head

The thermo-switch at the cylinder head serves to monitor the generator temperature. All thermo-switches for the generators from Panda 6.000 upward are two-pole (earthed), so called „openers“. This means the contacts are open in normal cases and close only when the limits have been exceeded.

Fig. 4.3.4-1: Thermo-switch at cylinder head



##### Thermo-switch at exhaust connection

If the impeller pump stops and delivers no more raw water, the exhaust connection becomes extremely hot.

Fig. 4.3.4-2: Thermo-switch at exhaust connection

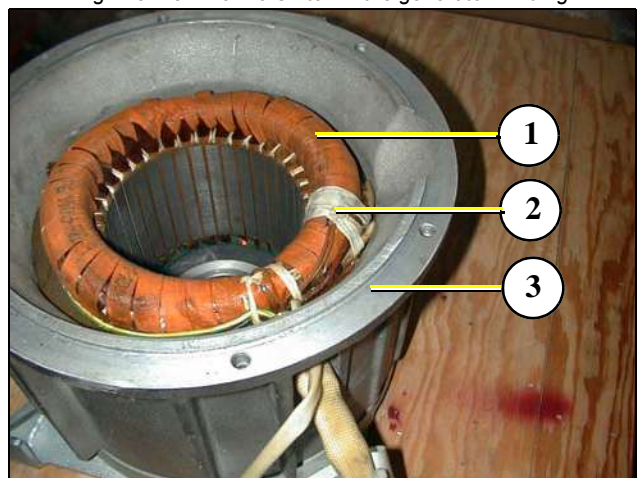


##### Thermo-switch in the generator winding

1. Generator winding
2. Thermo-switch
3. Housing

Two thermo-switches inside the windings to protect the generator winding, which for safety reasons are installed independently in parallel.

Fig. 4.3.4-3: Thermo-switch in the generator winding

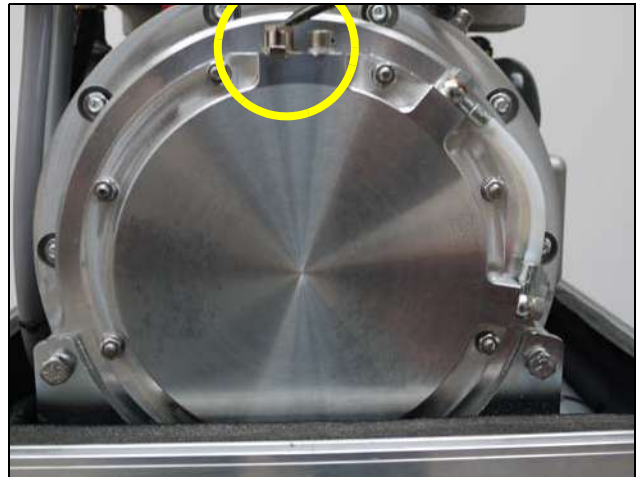




## Thermo-switch at the front plate (Models with oil cooled bearing only)

The generator bearing is equipped with an oil thermo-switch, which switches the engine off, if the oil temperature becomes too high.

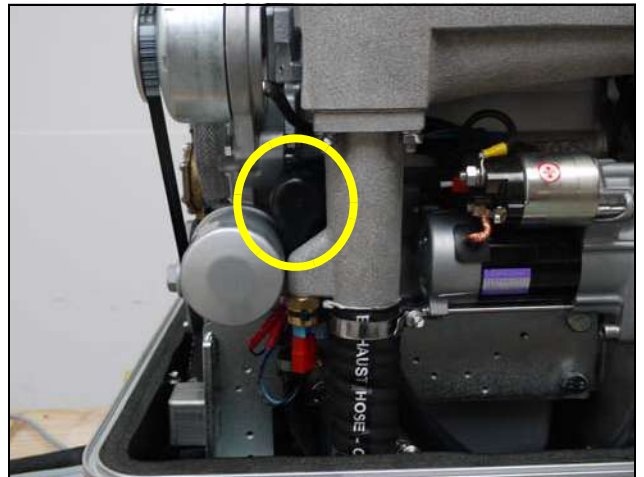
Fig. 4.3.4-4: Oil thermo-switch



## Oil pressure switch

In order to be able to monitor the lubricating oil system, an oil pressure switch is built into the system. The oil pressure switch is at the rear of the engine (In front of the electrical starter).

Fig. 4.3.4-5: Oil pressure switch



## Failure bypass switch

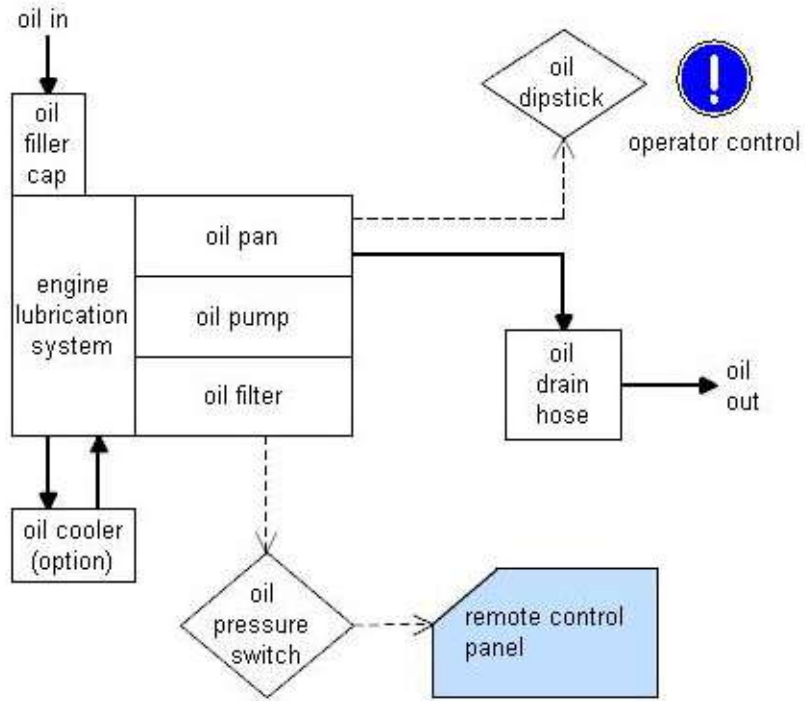
The failure bypass switch offers the possibility of starting the generator if the electrical control switches off due to overheating of the cooling system.

Fig. 4.3.4-6: Failure bypass switch



### 4.3.5 The Oil Circuit - Schema

Fig. 4.3.5-1: The Oil Circuit - Schema





## 5. Generator operation instruction

### 5.1 Personal requirements

---

Only instructed persons are allowed to run the generator. Instructed Persons has read the manual of the generator and all ancillary components and external equipment. He must be acquainted with the specific risks and safety instructions.

Only persons who are expected to perform their tasks reliably are permitted as personnel. Persons whose reaction capability is impaired, e.g. through drugs, alcohol or medication are not permitted.

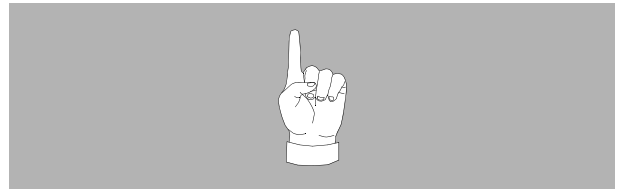
When selecting the personnel, the stipulations regarding age and occupation applying at the location must be observed.

### 5.2 Hazard notes for the operation

---

**Please note the safety first instructions in front of this manual.**

**Notice!**



**Danger for life! - The generator can be equipped with an automatic start device. This means the generator can be started by an external signal.**

**Warning!: Automatic start**



To avoid an unexpected starting of the generator, the starter battery must be disconnected before start working at the generator.

#### **Rotating parts inside of the generator**

**Attention!: Danger to life**



Do not run the generator with removed sound cover. If it is necessary to test the generator without sound cover, pay special attention. Never do this work alone. Do all service, maintenance and repair with engine stopped.

**Danger for Life. Improper handling, operation, installation and maintenance can result in severe personal injury and/or material damage.**

**Attention!: Danger to Life - High voltage**



Electrical voltages above 48 volts (battery chargers greater than 36 volts) are always dangerous to life). The rules of the respective regional authority must be adhered to. Only an electrician may carry out installation of the electrical connections for safety reasons.

### 5.3 General operating instruction

---

#### 5.3.1 Operation at low temperatures

---

The Generator can be started at temperatures down to - 20 °C, therefore the operation fluids like fuel, cooling water,



lubricant oil ect. must be suitable for this temperatures. These should be checked before start. Cold start spray ect. are not allowed to use, or the warranty will be lost.

### 5.3.1.1 Pre-heating the diesel motor

Pre.champer diesel engines are equipped with a quick glow plug. The maximum pre glow time should not exceed 20 sec. At 20 °C or more the pre glow time should be about 5-6 sec. Below 20 °C the pre glow time should be increased,

**If the operation fluids have been drained and then filled with cold weather fluids, always run the generator for 10 minutes to ensure the new fuel is present throughout the system.** **Note:**



### 5.3.1.2 Tips regarding starter battery

Fischer Panda recommends normal starter battery use. If an genset is required for extreme winter conditions, then the starter battery capacity should be doubled. It is recommended that the starter battery be regularly charged by a suitable battery-charging device (i.e., at least every 2 Months). A correctly charged starter battery is necessary for low temperatures.

## 5.3.2 Light load operation and engine idle

---

If an engine is operated on a load less than 25-30 % of its rated output, the soot of the generator will be observed which may give cause for concern. The usual results of this operation are heavier than normal lubricating oil consumption, and oil leaks from the air and exhaust manifolds. This condition is particularly evident on standby generator set applications.

### 5.3.2.1 The soot of the generator is due to the fact that:

The cylinder temperatures are too low to ensure complete burning of all the fuel delivered.

A further result is that of abnormal carbon build-up on the valves, piston crowns and exhaust ports. Fuel dilution of the lubricating oil will also occur.

### 5.3.2.2 To prevent the soot of the generator following steps should be observed:

Running on light load should be avoided or reduced to the minimum period.

In a period of 50 operation hours the engine or generator set should be run on full load for four hours, to burn off accumulations of carbon in the engine and exhaust system. This may require the use of a 'dummy load'. The load should be built up gradually from 30 % to 100 % within 3 hours and hold at 100 % for one hour.

## 5.3.3 Generator load for a longer period and overload

---

Ensure the generator is not overloaded. Overloading occurs when the electrical load is higher than the generator can provide. If this occur for a longer period, the engine may be damaged. Overloading may cause rough running, high oil and fuel consumption, increased emissions.

For a long engine life, the long therm load should not exceed 80 % of the nominal load. Long therm load is the load over several hours. It is harmless for the generator to deliver full nominal power for 2-3 hours.

The hole conception of the Fischer Panda generator make sure, that the full power operation at extreme condition will not increase the engine temperatures over. Please note that the emissions of the generator also increase at full power operation.



### 5.3.4 Protection conductor:

---

The standard Panda generator is grounded. The 3-phase connection (delta) centre point is bridged to earth in the AC output terminal box (mounted on the generator). This is the initial earth safety point and is sufficient to ensure safe operation however only as long as no other system is installed. This system is adapted to enable test running of the generator before delivery.

The bridge to ground (PEN) is only effective when all components in the electrical system share a common ground. The bridge to ground can be removed and reconnected to another ground system if required for other safety standards.

Full voltage connections are mounted in the electrical cabinet. It must be ensured that the electrical cabinet is secured and closed while the generator is running.

The starter battery cable should be disconnected when work is being done on either the generator or the electrical system in order to prevent accidental starting of the generator.

### 5.3.5 Operating control system on the Fischer Panda generator

---

Fischer Panda generators are equipped with various sensors/temperatures switches. The combustion engine is further equipped with a oil pressure control switch, which switches the motor off, if the oil pressure sinks to a particular level.

## 5.4 Instructions for capacitors - not present at all models

---

#### Danger to Life - High voltage

#### CAUTION!

Do not touch the capacitor contact terminals!



The generator's electrical system requires two different groups of capacitors:

- A) The booster capacitors
- B) The operating capacitors

Both types are mounted in the electrical cabinet. (At some models direct on the generator)

Capacitors store an electrical charge. It is possible that even after they have been disconnected stored energy is still held. Therefore it is essential that the connectors are not touched.

Should it be necessary to check or test the capacitors, they should be shorted out by using an insulated screw driver.

The operating capacitors are automatically discharged when the generator is stopped in the normal way. The booster capacitors will be discharged through internal resistors.

For safety however, the capacitors have to be discharged (short circuited) prior to carrying out any work on the AC-Control box.

## 5.5 Checks before start - see remote control panel data sheet

---

**The instructions and regulations of the remote control panel data sheet must be respected.**

**Note:**

*Respect the safety instruction in front of this manual.*





### 5.6 Starting the generator - see remote control panel data sheet

---

---

The instructions and regulations of the remote control panel data sheet must be respected.

Note:

*Respect the safety instruction in front of this manual.*



### 5.7 Stopping the generator - see remote control panel data sheet

---

---

The instructions and regulations of the remote control panel data sheet must be respected.

Note:

*Respect the safety instruction in front of this manual.*





## 6. Installation Instructions

All connections (hoses, wires etc) and installation instructions are designed and suited for “standard” installation situations.

In situations where Fischer Panda has no detailed information concerning certain installation requirements (such as vehicle specifications, maximum vehicle speed -and all other conditions concerning special operating situations) the installation instructions should be used as an example guide only.

The installation must be undertaken and proved by a suitable qualified/trained person and may in accordance with the law as required by the country and special situation.

Damages caused by faulty or incorrect installation are not covered by the warranty.

### 6.1 Personal requirements

The described installation must be done by a technical trained person or a Fischer Panda service point.

#### 6.1.1 Hazard notes for the installation

see “Safety first!” on Page 12.

Follow the general safety instruction at the front of this manual.

**Working at a running generator can result in severe personal injury. Therefore before starting work at the generator:**

Make sure that the generator is stopped and the starter battery is decanted to guarantee that the generator cannot be inadvertently started.

Do not run the generator with removed sound isolation cover

**Improper installation can result in severe personal injuries or material damage.**

- Always undertake installation work when the generator is switched off.
- Ensure there is sufficient installation clearance before start working.
- Ensure tidiness and cleanliness at the workplace. Loose components and tools lying around or on top of each other are sources of accidents.
- Only perform installation work using commercially available tools and special tools. incorrect or damaged tools can result injuries.

*Notice!:*



**Warning!: Risk of injury**



**Warning!: Risk of injury**



**Oil and fuel vapours can ignite on contact with ignition sources. Therefore:**

- No open flames during work on the generator.
- Do not smoke.
- Remove oil and fuel residues from the generator and floor.

**Contact with engine oil, antifreeze and fuel can result in damage to health. Therefore:**

- Avoid skin contact with engine oil, fuel and antifreeze.
- Remove oil and fuel splashes and antifreeze from the skin immediately.
- Do not inhale oil and fuel vapours.

**Danger for Life. Improper handling, operation, installation and maintenance can result in severe personal injury and/or material damage.**

Electrical voltages above 48 volts (battery chargers greater than 36 volts) are always dangerous to life). The rules of the respective regional authority must be adhered to. Only an electrician may carry out installation of the electrical connections for safety reasons.

**Generator, oil and antifreeze can be hot during/after operation. Risk of severe burns.**

**During Installation/maintenance personal protective equipment is required to minimize the health hazards.**

- Protective clothing
- safety boots
- protective gloves
- Ear defender
- safety glasses

**Disconnect all load during the work at the generator to avoid damages at the load.**

**-Warning!: Danger of fire**



**Danger!: Danger of poisoning**



**ATTENTION!: Danger to Life - High voltage**



**Warning!: Hot surface/material**



**Instruction!: protective equipment necessary.**



**Attention!: disconnect all load**





## 6.2 Preparing the base - Placement

Since Panda generators have extremely compact dimensions, they can be installed in tight locations. Attempts are sometimes made to install them in almost inaccessible places. Please consider that even almost maintenance-free machinery must still remain accessible at least at the front (drive belt, water pump) and the service-side (actuator, dipstick). Please also note that in spite of the automatic oil-pressure sensor it is still essential that the oil level has to be checked regularly.

The generator should not be placed in the proximity of light walls or floors, which can have resonance vibrations because of airborne sounds. If this should be unavoidable, then it is recommended that this surface is lined with 1 mm lead foil, which will change the mass and the vibration behaviour.

You should avoid fixing the generator on a slippery surface with little mass (i.e.). This acts as an amplifier of airborne sounds in the most unreasonable case. An improvement can be achieved by reinforcing these surfaces with ribs. In addition, the breakthroughs, which interrupt these surfaces, should be sawed off. The lining of the surrounding walls with a heavy layer (i.e. lead) and foam additionally improve the conditions.

The generator sucks its air from the surrounding engine room. Therefore it must be ensured that sufficient ventilation openings are present, so that the generator cannot overheat.

High temperature of the intake air decline the power of the generator and increases the coolant temperature. Air temperatures of more than 40 ° C reduce the power by 2 % per temperature rise of 5 ° C. In order to keep these effects as small as possible, the temperature in the engine room should not be higher than 15 ° C in relation to the outside temperature.

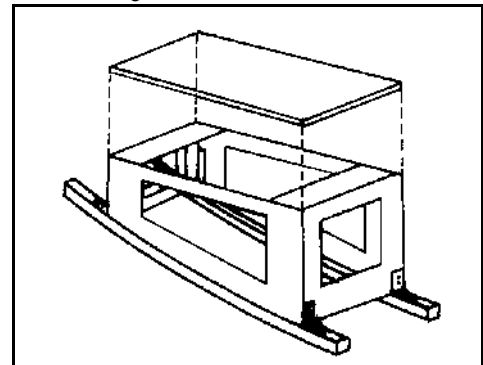
### 6.2.1 Advice for optimal sound insulation

The convenient base consists of a stable framework, on which the generator is fastened by means of shock-mounts.

Since the aggregate is „free“ downward, the combustion air can be sucked in unhindered.

In addition are void the vibrations, which would arise with a closed soil.

Fig. 6.2.1-1: Generator Base



## 6.3 Generator Connections

Connect all electrical wires within the capsule tightly to the motor and the generator. This is also the case for fuel lines and cooling water lines.

The electrical connections **MUST** be carried out according to the respective valid regulations. This also concerns used cable materials. The cable supplied is meant for laying „protected“ (i.e. in pipe) at a temperature up to a max of. 70 ° C (160 ° F). The on-board circuit must also be fitted with all essential fuses.

**Before working (installation) on the System read the section „Safety Instructions“ in this Manual.**

**ATTENTION!**



## 6.4 Installation of the cooling system - raw water

### 6.4.1 General Information

The genset should have its own raw water (coolant water) inlet and should not be connected to any other engine systems. Ensure that the following installation instructions are complied with:

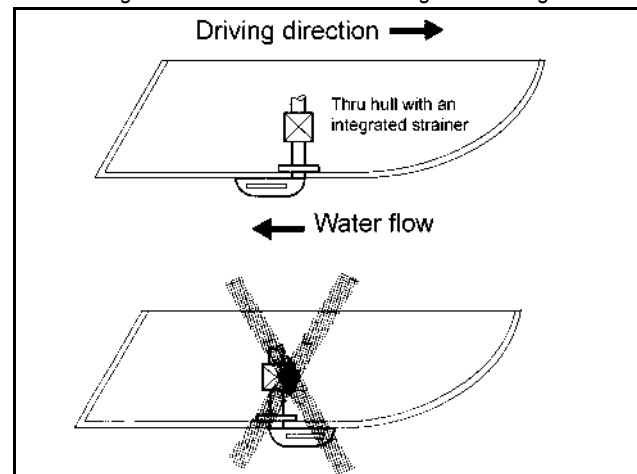
**For the avoidance of galvanic corrosion, refer to the chapter „Service instruction for marine generators (corrosion protection)“.**

### 6.4.2 Installation of the through hull fitting in Yachts

It is good practice for yachts to use a through hull fitting with an integrated strainer. The through hull fitting (raw water intake) is often mounted against the sailing direction to induce more water intake for cooling.

**For Panda generators, the through hull inlet should NOT point in the sailing direction! When sailing at higher speeds more water will be forced into the inlet than the pump can handle and your generator will flood!**

Fig. 6.4.2-1: Position of the Through Hull Fitting



### 6.4.3 Quality of the Raw Water Sucking In Line

In order to keep the suction resistance in the line at a minimum, the raw water intake system (i.e. sea cock, through-hull fitting, inlet filter, etc.) must have an inner diameter of at least 1" (25 mm).

This applies also to installation components such as through-hull fitting, sea cock, raw water filter etc.

The intake suction line should be kept as short as possible. Install the raw water inlet in close proximity to the genset.

**After start-up the cooling water quantity must be measured (e.g. by catching at the exhaust). The flow rate, as well as the necessary cross section of the cooling water pipe see section 9.10, "Diameter of conduits," on page 207**

### 6.4.4 Generator Installation above Waterline

The Panda is equipped with a direct drive water intake pump mounted directly on the motor. Since the intake pump is an impeller pump there are wearing parts which are likely to require replacement after a period of time. Ensure that the genset is installed so that the intake pump can be easily accessed. If this is not possible, an external intake pump could be installed in an easily accessible location.

If the generator is installed above the waterline, it is possible that the impeller will wear out faster, because after starting, the pump runs dry for some seconds.

The raw water hose should form a loop as near as possible to the raw water inlet of the generator (see picture below). This ensures the pump only sucks in air for a short time. The impeller pump will be lubricated by raw water and the impeller life span will be increased.

By the installation of a check valve in the raw water inlet line, which is under the waterline, this problem can be restricted.

The impeller pump will remain intact longer, if an electrical booster pump is installed, and is strongly recommended in order to preserve the impeller pump.

**Never change the impeller for many years, without exchanging the old pump. If the sealing ring is defective within the pump, raw water runs into the sound cover of the genset. A repair is then very expensive.**

**NOTE:**



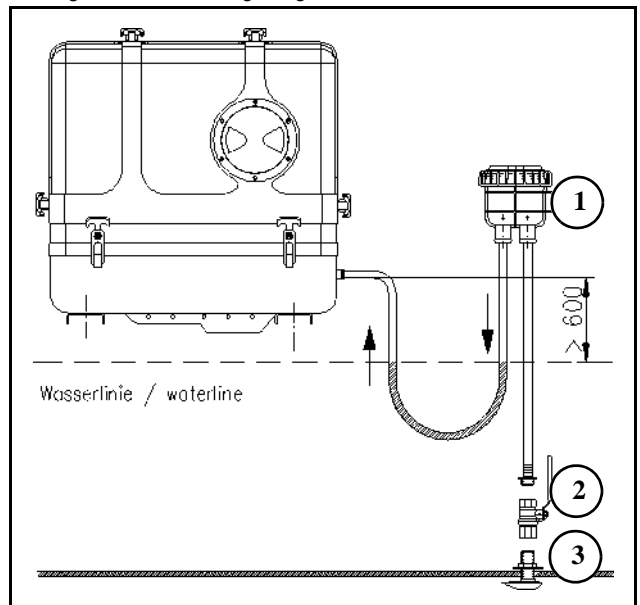
**Replacement impeller and also a spare pump should always be on board. The old pump can be sent back to Fischer Panda.**

**Installation above water level**

1. Raw water filter
2. Water cock
3. Through hull

Make certain that the raw water filter lies above the water level, otherwise when cleaning, water can penetrate by the through hull. An external pre-pump can relieve the impeller.

Fig. 6.4.4-1: Installing the generator above the water level



### 6.4.5 Generator Installation below Water-Line

If the generator cannot be attached at least 600 mm above the waterline, a vent valve must be installed at the raw water line.

Possible heeling must be taken into consideration if installed at the „mid-ship line“!

The water hose for the external vent valve is located at the back of the sound insulated cover. This hose is split in the middle and extended respectively at each end by an additional hose and a connecting nipple. Both hose ends must be led outside of the sound cover to one point, if possible 600 mm over the waterline in the mid-ship line. The valve is connected at the highest place to the two hose ends.

Fig. 6.4.5-1: Vent Valve



**Note:**

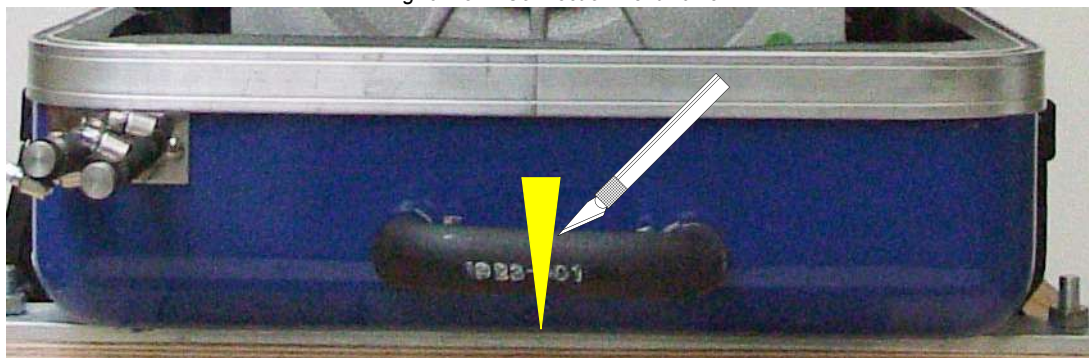


**The vent valve must be installed directly behind the water pump.**

**If the water pump ceases, the valve spring ensures that air can enter and therefore, a syphon effect is avoided.**

**The de-aeration valve must be regularly controlled. If the water pump stops, the valve spring ensures that air enters. It must be opened, cleaned and greased.**

Fig. 6.4.5-2: Connection Vent Valve



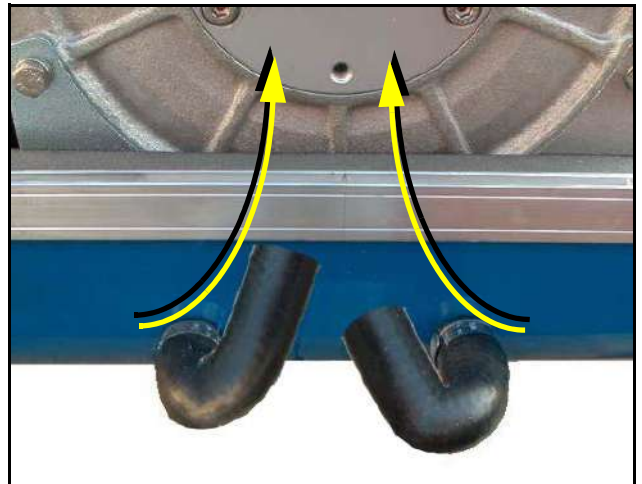
Cut the hose for the external vent valve....



...and bend it upwards.

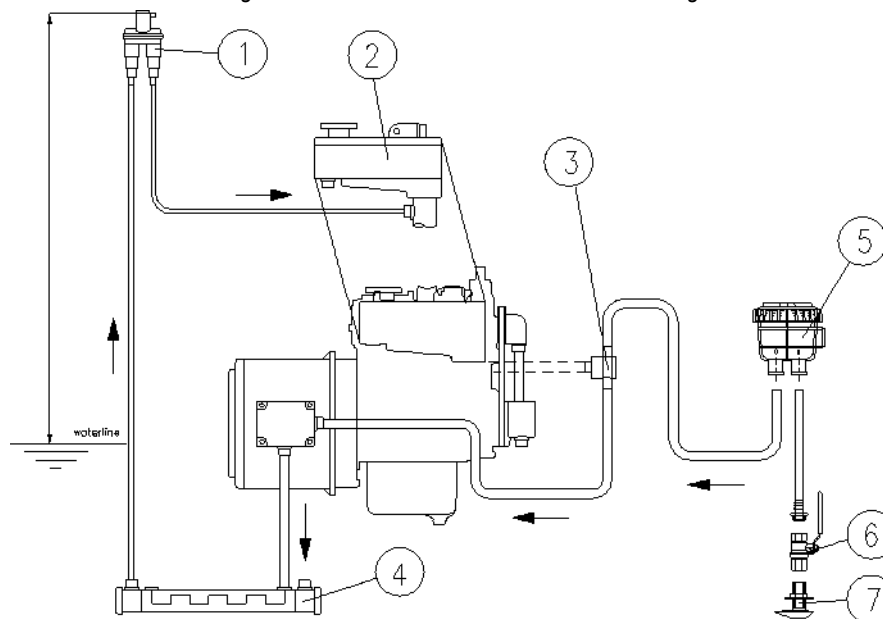
Both hose ends must be led out outside of the sound cover to one point, if possible 600 mm over the waterline at the mid-ships line. The valve is connected at the highest place with the two hose ends.

Fig. 6.4.5-3: Connection Vent Valve



### 6.4.6 Generator Housing cooled by Raw Water

Fig. 6.4.6-1: Installation Scheme for Direct Cooling

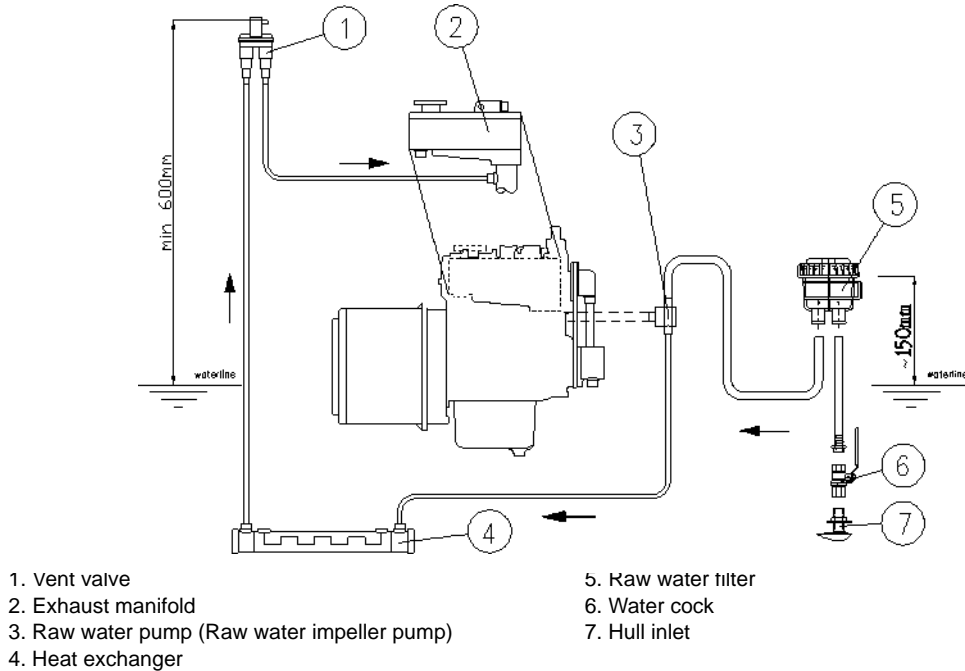


- 1. Vent valve
- 2. Coolant connection block
- 3. Raw water pump
- 4. Exhaust manifold

- 5. Raw water filter  $\varnothing$  1"
- 6. Water cock  $\varnothing$ 1"
- 7. Through hull

## 6.4.7 Indirect Cooling of the Genset Housing (by the Heat Exchanger)

Fig. 6.4.7-1: Installation Scheme Indirect Cooling of the Genset Housing



## 6.5 Installation of the cooling system - fresh water

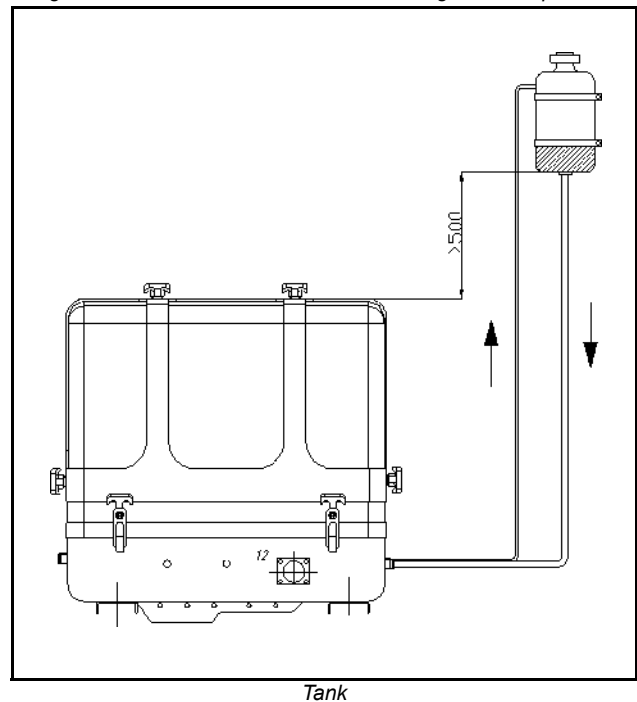
### 6.5.1 Position of the external cooling water expansion tank

#### Position of the external cooling water expansion tank

The Panda generator is normally supplied with an additional, external cooling water expansion tank. This tank must be installed in such a way that its lower edge is at least 500 mm more highly arranged than the upper edge of the sound cover.

If this 500 mm should be fallen below, i.e. the cooling water expansion tank is lower installed, very large problems can occur with filling and ventilating. Extend and displace the hose lines to the outside or possibly even up to the deck.

Fig. 6.5.1-1: Position of the External Cooling Water Expansion



The external cooling water expansion tank may be filled only up to the lower edge of the lower tension tape (see note „max“) in the maximum filling level in cold condition.

**ATTENTION!**



## 6.5.2 Ventilating at the first filling of the Internal Cooling Water Circuit

### Expansion Tank

1. Fill up the external cooling water expansion tank with coolant.

ATTENTION: maximum fill level = „max.“- mark.

The cover of the external expansion tank temporarily must be opened (all other closures are now closed!).

Fig. 6.5.2-1: Expansion tank



### Venting Screws

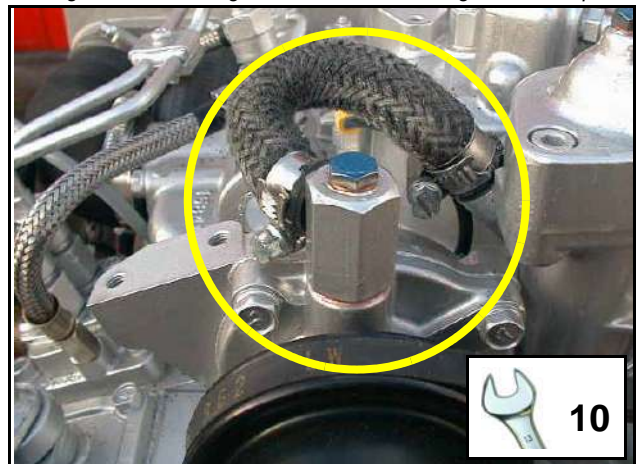
2. Open venting screw on the pipe socket of the internal cooling water pump. Close the vent screw when air free water comes out

- Check the water level in the expansion tank during the venting. Fill up if necessary.

Never open the vent screw while the generator is running.

Sample picture

Fig. 6.5.2-2: Venting screw - Internal Cooling Water Pump



3. Open vent screw on the thermostat housing. Close the vent screw when air free water comes out

- Check the water level in the expansion tank during the venting. Fill up if necessary.

Never open the vent screw while the generator is running

Sample picture

4. Start the Generator

After filling the generator it must be started. During this first phase of start-up, the generator may not be loaded. Switch the generator off after about 10 sek. of operation!

5. Repeat the steps 1-4 till no air comes out of the vent screw at thermostat housing.

Fig. 6.5.2-3: Venting screw - Thermostat housing



6. Close the vent screws.
7. Fill up the expansion tank.
8. Close the expansion tank.
9. Re-ventilating process 10 Operating hours after the first start-up (and if necessary)

**Also after the first implementing a small amount of air can be reside in the cooling circuit. To ensure an immaculate and actual operating of the cooling system the ventilating process must be repeated casual in the next few days (weeks, if necessary). Small amount of air will still exit out of the ventilating openings, especially if the generator stood still for a long time.**

During the ventilating process repeated checks must be made to check the cooling water is indeed circulating. If there are air bubbles in the internal cooling water pump, it could be that the cooling water is not circulating. The generator will heat up very quickly and switch off, because of overheating.

**ATTENTION!**



#### *Anti-freeze*

*In the interest of safety, the freezing point of the closed circuit coolant should be checked on a regular basis. Be sure that the coolant/antifreeze mixture is good for at least -15°C (5 ° F) and if it is possible that your genset experiences lower temperatures, for example during storage or transportation, then the entire cooling system should be drained and purged*

### **6.5.3 Pressure Test for Controlling the Cooling Water Circuit**

---

Check if a temperature difference exists between cooling water in-flow and cooling water return flow by use of the hand.

Feel the cooling water in-flow line at the internal cooling water pump.

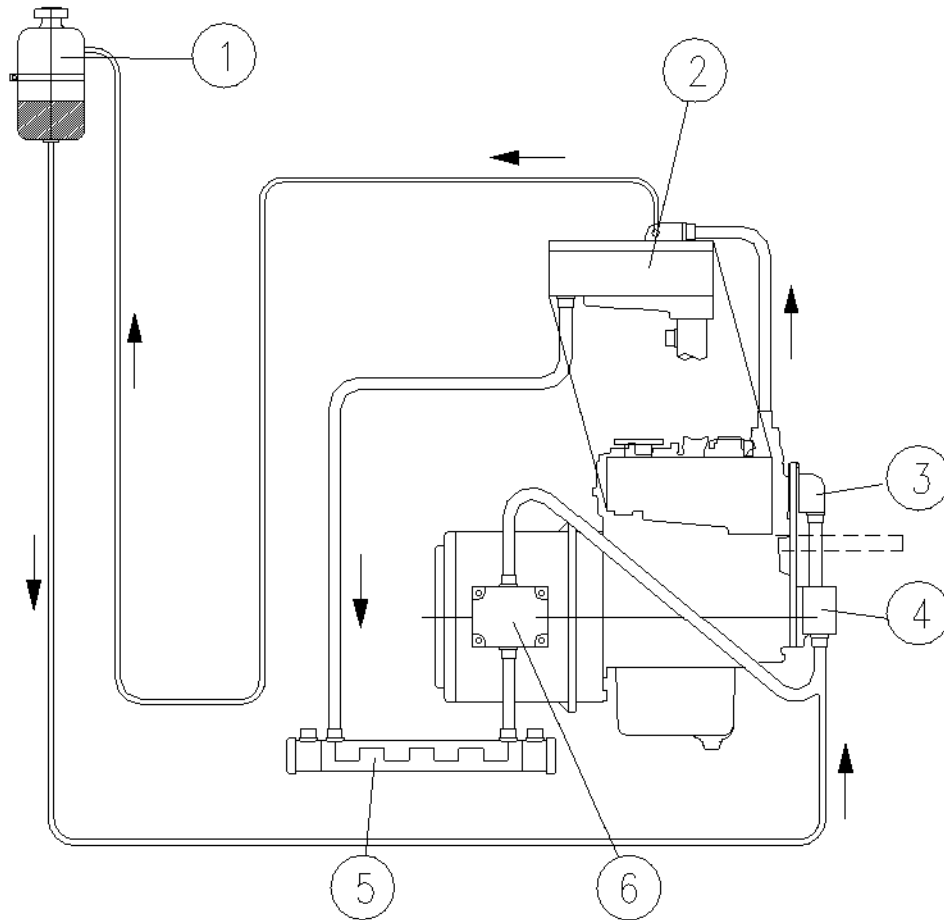
Feel the cooling water return pipe either at the outlet of the water-cooled exhaust elbow union or at the side, where this pipe exits at the heat exchanger.

The temperature difference between in-flow and return should be approximately 10 degrees.



### 6.5.4 Scheme for Freshwater Circuit at Two Circuit Cooling System

Fig. 6.5.4-1: Scheme for Freshwater Circuit at Two Circuit Cooling System



- 1. Expansion Tank
- 2. Exhaust Manifold
- 3. Thermostat Housing

- 4. Freshwater pump
- 5. Heat Exchanger
- 6. Cooling Water Connection Block



### 6.6 Installation of the water cooled exhaust system

#### 6.6.1 Installation of the standard exhaust system

The generator exhaust system must remain completely independent and separate from the exhaust system of any other unit(s) on board. The water lock must be installed at the lowest point of the exhaust system. An optional noise insulated water lock can also be installed. The exhaust hose descends from the capsule to the water lock. Then the hose rises via the „goose neck“ to the silencer (see drawing). The goose neck must be vertical and sit preferably along the ship's keel centre line. In order that the back pressure inside the exhaust is not too high, the total length of the exhaust system should not exceed 6 m (20 ft.)

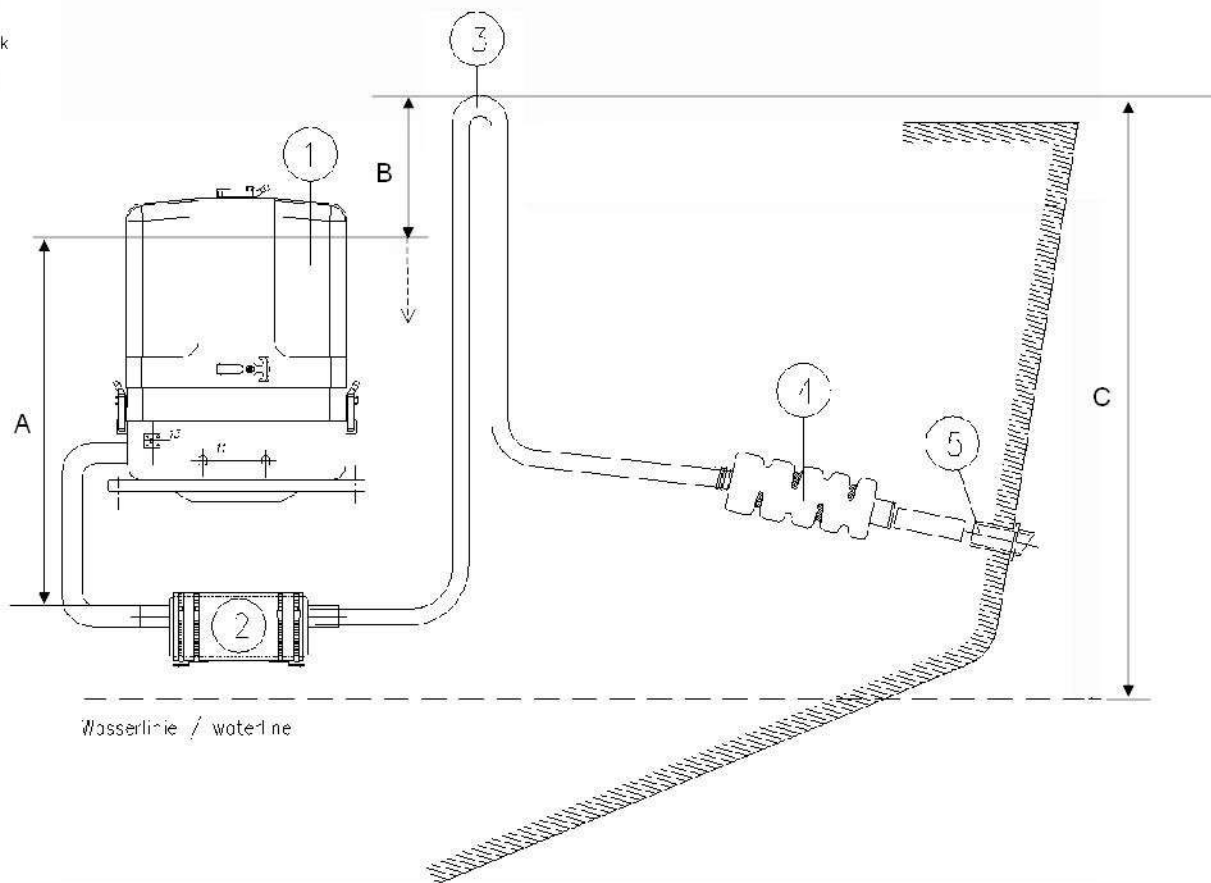
By injecting the outlet raw water into the exhaust manifold, the exhaust gases are cooled and the noise emissions from the exhaust system are reduced.

*Exhaust diameter see section 9.10, "Diameter of conduits," on page 207*

Fig. 6.6.1-1: Installation Scheme Standard Exhaust System

- A Position exhaust elbow at the generator to the muffler min.600mm
- B Position goose neck to the exhaust elbow at the generator max. 500mm above the exhaust elbow down to max. 800mm under the exhaust elbow
- C Position goose neck to the water line min. 600mm

- 1 Generator
- 2 Muffler
- 3 Goose neck
- 4 Silencer
- 5 Hull outlet



## 6.7 Installation of the waterlock

---

Pay attention to the right flow direction through the waterlock.

**Note!**



Unfortunately, it can occasionally occur that, because of an disadvantageous mounting position of the waterlock, sea water gets into the diesel engines' combustion chamber. This disables the diesel engine by irreversible damages. Quite frequently, this leads to discussions during which the parties involved in the yachts' construction or the installation of the generator have to explain themselves.

**One point in this situation can be clarified definitely:**

If sea water gets into the inner section of the engine, this is not possible due to constructional defects of the generator or to malfunctions on the engine itself. It can only reach the combustion chamber via the exhaust hose and thus get into the engine.

Thereby, the position of the generator and the waterlock, as well as the arrangement of the cooling water and exhaust hoses play the decisive role.

If the waterlock is arranged in an unfavourable position, the cooling water flowing back in the exhaust hose can rise so high, that it reaches the exhaust stack. Since at least one discharge valve is always open when the engine is shut off, the sea water has free access to the combustion chamber. By capillary action, this sea water then flows past the cocks and even reaches the engine oil in that way. (In fact, a surprisingly high oil level is a first indication of an upcoming catastrophe).

**If an usual high oil level can be detected and/or the oil is of a greyish colour, the engine must not be used anymore. This is a certain sign for cooling water that got into the oil pan. If the engine is started under these conditions, the water and the oil are mixed into an emulsion. The oil will quickly become so viscous that one will have to call it a paste. In this phase the fine oil hoses are blocked and a few moments later the machine gets destroyed because of insufficient lubrication. Before this happens, an immediate oil change should be made. Since the water can only reach the engine via the combustion chamber, it can be assumed that the compression rings will start to corrode. These effects have to be discussed with an engine expert. It will certainly be reasonable to immediately inject plenty penetrating oil through the intake stack and to slowly turn the engine with the starter motor.**

The cooling water can reach the exhaust area via the exhaust hose as well as via the cooling water feed.

### 6.7.1 Possible cause for water in the exhaust hose

---

#### 6.7.1.1 Possible cause: exhaust hose

If the cause is the exhaust hose itself, the following points are to be checked at the hose:

- Position of the waterlock is too high. The water reaches the exhaust hose.
- Position of the waterlock is too far away from the middle of the generator. The water reaches the exhaust hose in tilted position.
- The waterlock is too small relating to the length of the exhaust hose.

#### 6.7.1.2 Possible cause: cooling water hose

If the generator is not clearly installed 600 mm over the water line, the cooling water feed must be equipped with a „venting valve“ which is at least led out 600 mm over the water line. (This position must also be assured in every tilted position. Therefore, the venting valve should be located in the ships' center line, so that it cannot move in tilted position).

- Position of the venting valve is too low. The water flows into the exhaust area when the ship is tilted.

b) Position of the venting valve is too far from the ships' center line. The water reaches the exhaust area when the ship is tilted.

c) The venting valve does not work, because it jams or it is clogged. (The venting valve's function needs to be checked regularly.)

As it consistently happens that functioning risks are not realised during the laying of the exhaust hose, the following explanations refer explicitly to the exhaust hose. Here, the location, the size and the position of the „waterlock“ play a very decisive role:

### 6.7.2 Installation area of the waterlock

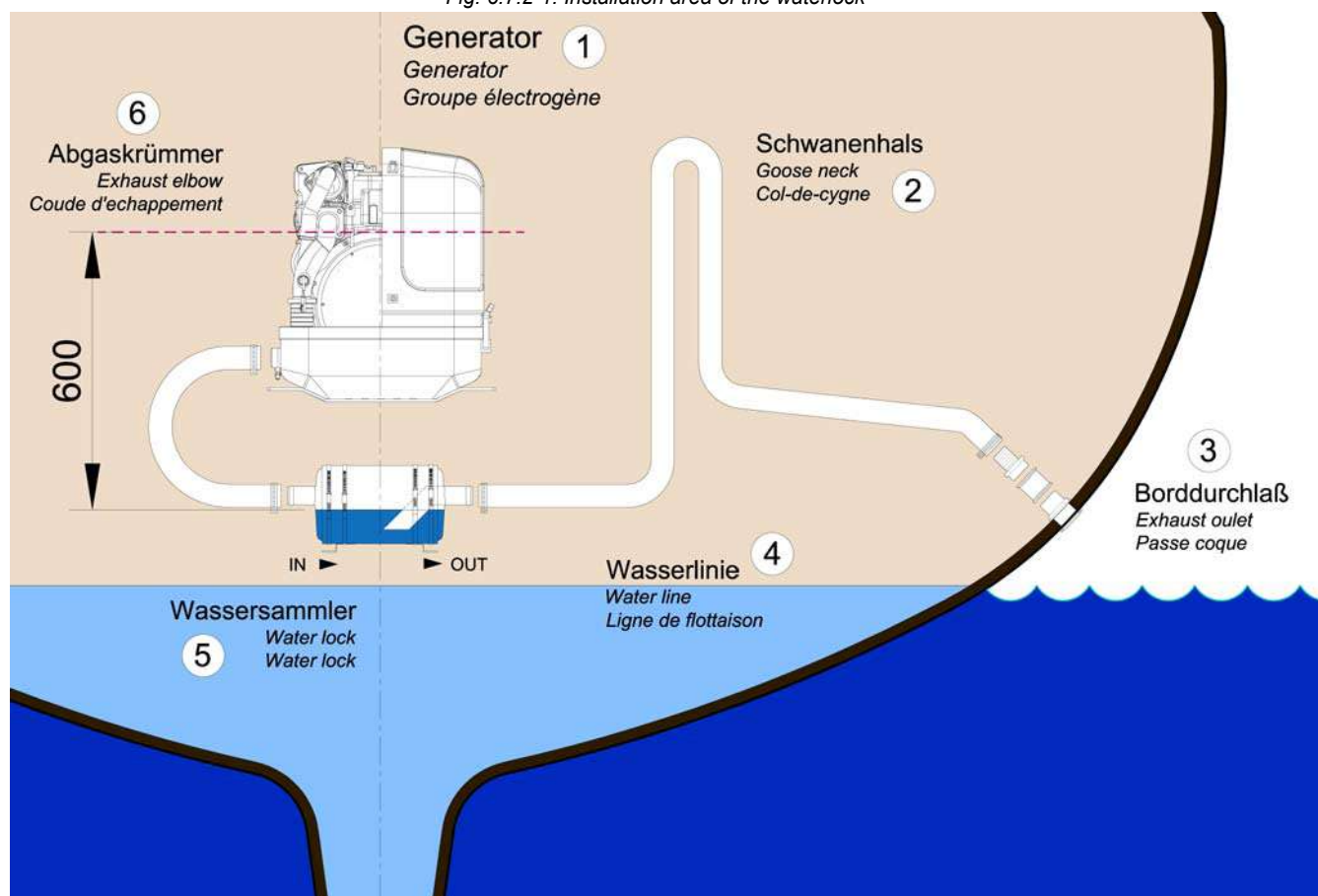
Concerning a water-cooled exhaust system, it must be regarded that - under no circumstances - cooling water from the exhaust hose can get into the exhaust elbow area at the engine. If this happens, the cooling water can get into the combustion chamber via an open discharge valve. This would lead to irreparable damage at the engine.

In addition to that, one has to reckon with possible tilted positions of sailing yachts, which makes the position of the waterlock even more important. In general one could say that:

The deeper the waterlock is located underneath the generator, the better the protection from entering water into the combustion chamber.

The picture below shows that the distance between the critical point at the exhaust elbow and the maximum permissible water level in the exhaust hose is stated with 600 mm. This distance should be understood as a minimum distance.

Fig. 6.7.2-1: Installation area of the waterlock



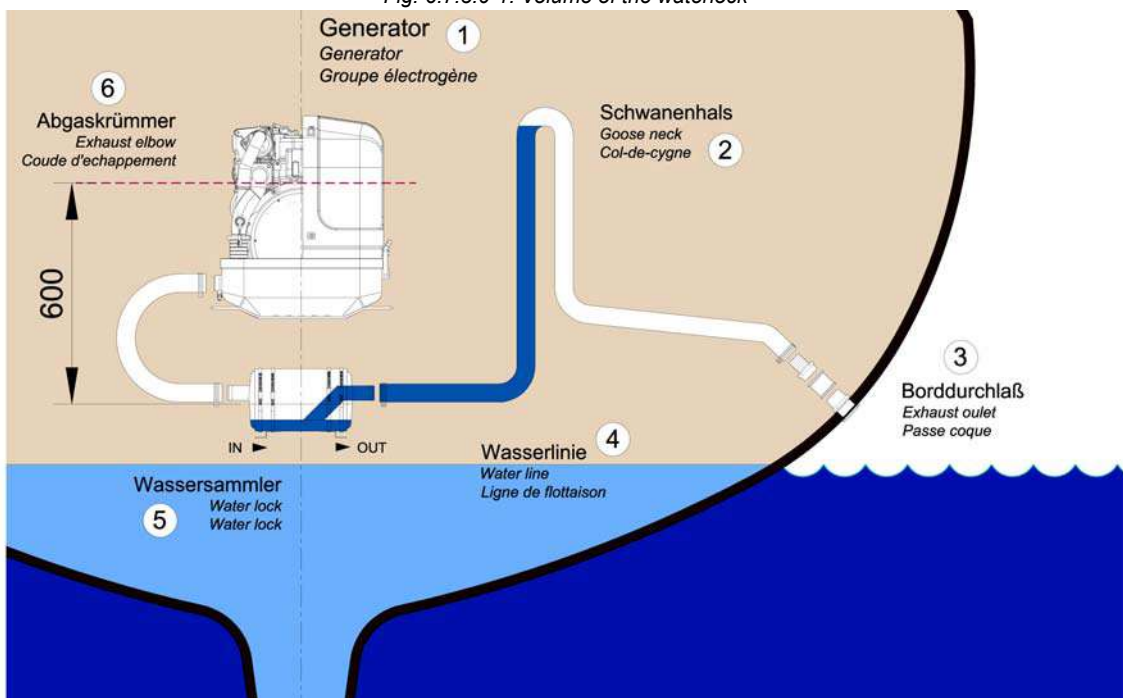
### 6.7.3 The volume of the waterlock

The waterlock must be measured so large, that it can take the entire amount of water flowing back from the exhaust

hose. The amount of water depends on the hoses' length (L) and its cross section. While the diesel engine is running, cooling water is continuously injected into the exhaust system and is carted outside with the emissions by the exhaust gas pressure. When the engine is turned off, the number of revolutions sinks quite fast. By doing so, the point is reached where the exhaust gas pressure does not suffice anymore to cart the cooling water out. All cooling water remaining in the hose at that point flows back into the waterlock. At the same time, the diesel engine itself continues to cart cooling water through the cooling water pump, as long as it keeps on rotating.

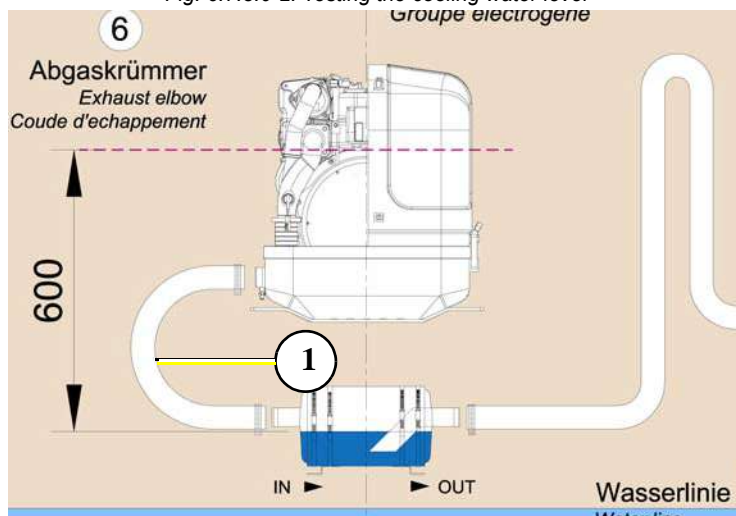
**The waterlock must necessarily be measured large enough that it can take the entire amount of cooling water and, at the same time, does not exceed the prescribed vertical height of 600 mm up to the critical point at the exhaust elbow.**

Fig. 6.7.3.0-1: Volume of the waterlock



If there are any doubts, a verification can easily be made by temporarily using a clear-sighted hose (1) as exhaust hose. In that way, the cooling water level can be checked very easily.

Fig. 6.7.3.0-2: Testing the cooling water level



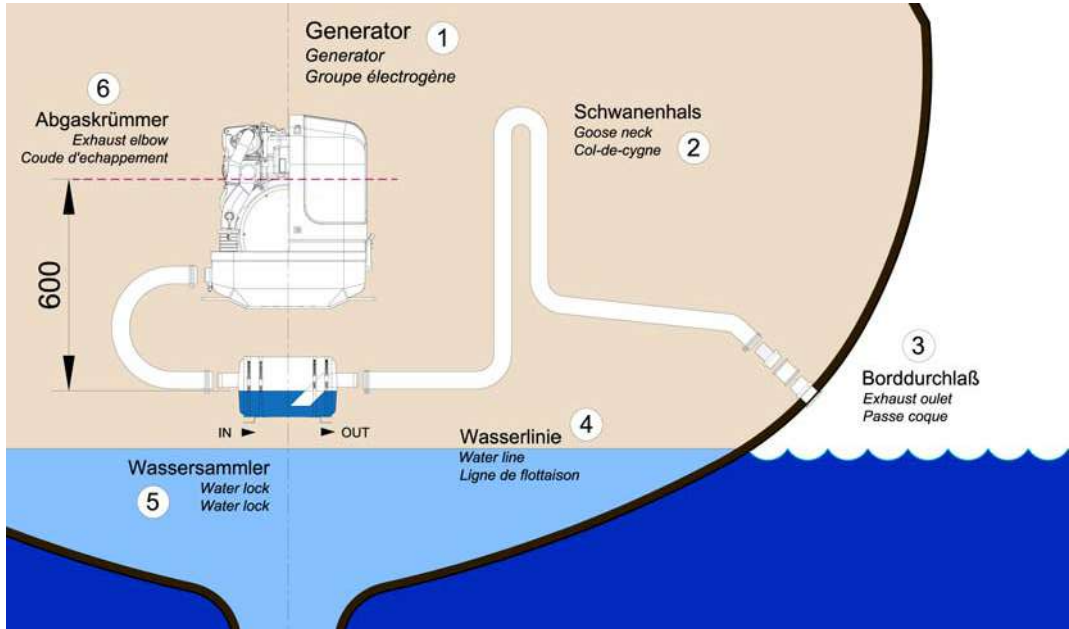


### 6.7.3.1 Ideal position of the waterlock

#### Important Note!

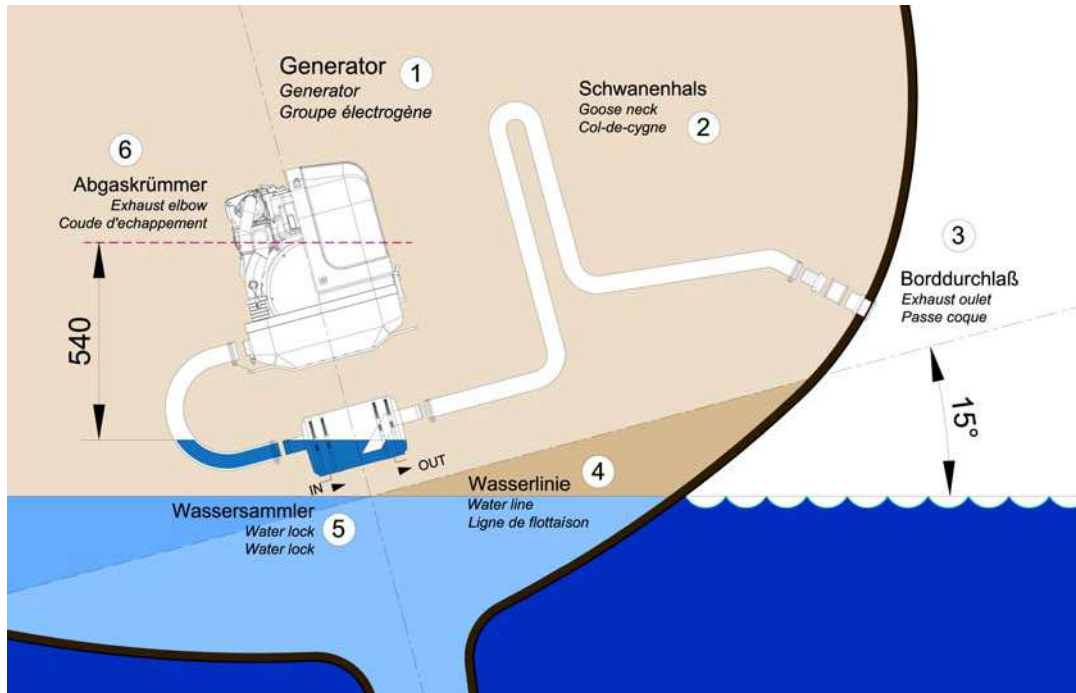
The ideal position of the waterlock would be in center underneath the generator. Only in this position it is assured that the water level cannot change drastically in tilted position by the waterlock moving out of the center line. See the following pictures:

Fig. 6.7.3.1-1: Ideal position of the waterlock



In Fig. 6.7.3.1-1, the waterlock is mounted in center underneath the generator. When the ship tilts, the position of the waterlock related to the critical point at the exhaust hose, changes only slightly.

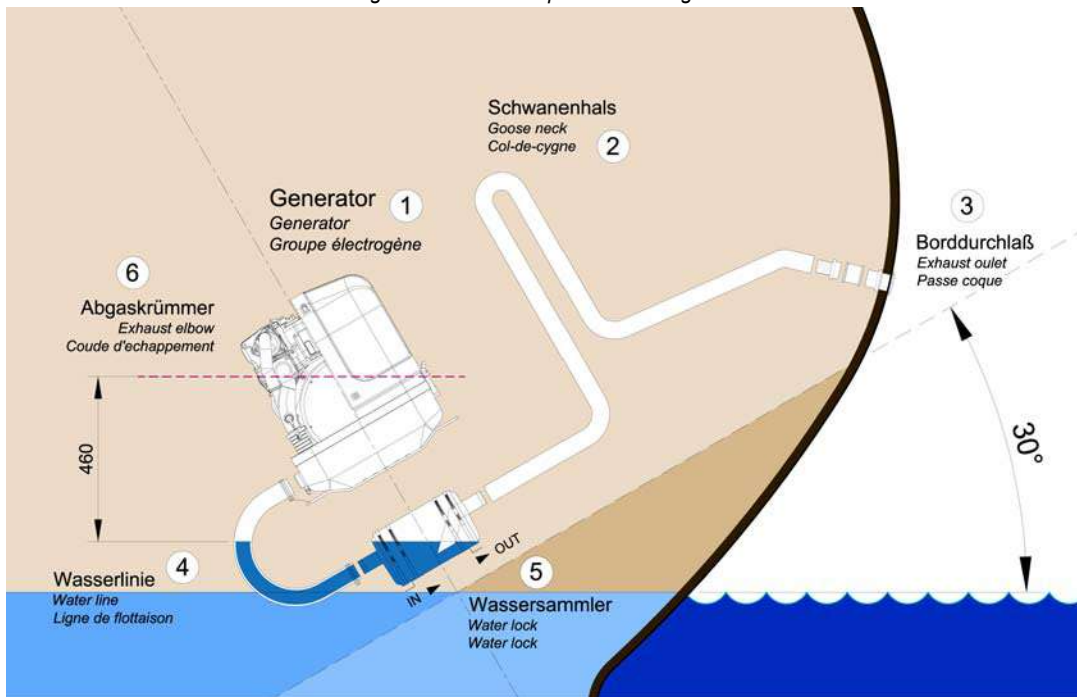
Fig. 6.7.3.1-2: Tilted position 15 degrees



#### Tilted position 15 degrees - Fig. 6.7.3.1-2

The distance from the exhaust elbow to the hydrostatic head has derated to 540 mm.

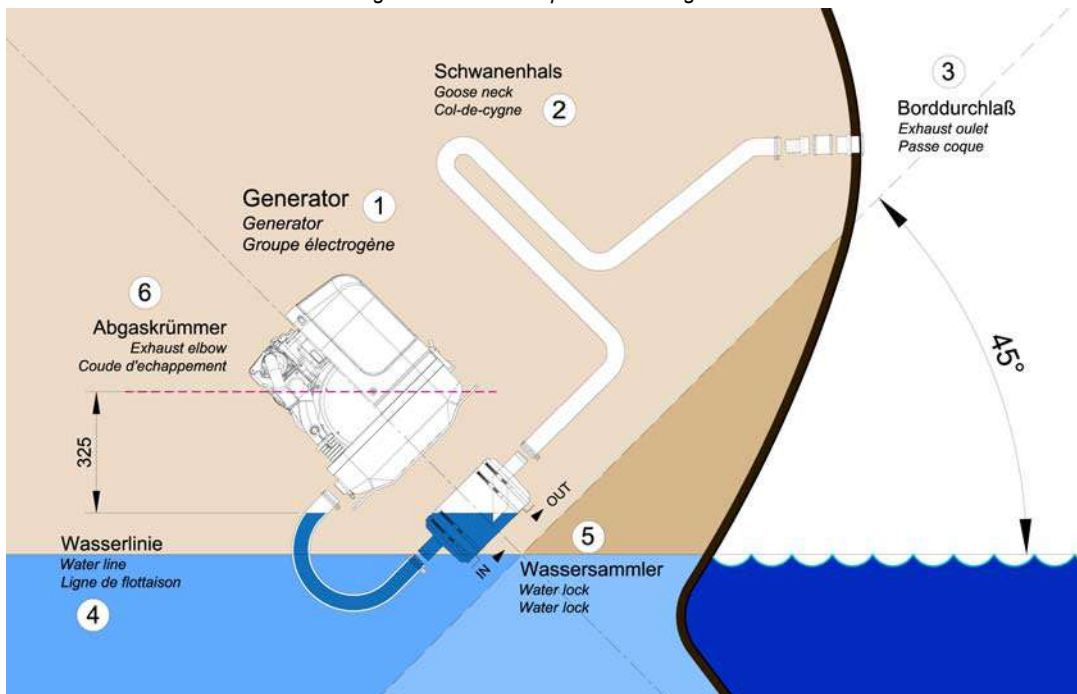
Fig. 6.7.3.1-3: Tilted position 30 degrees



**Tilted position 30 degrees - Fig. 6.7.3.1-3**

The distance of the water level, even in ideal position, changes that only 458 mm distance remain. So the critical distance is under-run already.

Fig. 6.7.3.1-4: Tilted position 45 degrees



**Tilted position 45 degrees - Fig. 6.7.3.1-4**

In this case the water level rise so high, that the distance constitutes only 325 mm.

Even when the water lock is mounted in the ideal spot, at an extremely tilted position of 45 degrees there is still the risk that water can get straight into the discharge stack area through strong rocking motions („sloshing“). This shows that the distance of 600 mm represents a minimum size at which, even when installed ideally, the water can slosh into the exhaust elbow when the ship is very tilted or rocks very hard.



### Summary:

The preset minimum height of 600 mm must be regarded unconditionally and is only valid if the waterlock is mounted in its ideal position in center underneath the generator. A higher position is highly recommended if it has to be reckoned with tilted positions of 45 degrees.



### 6.7.3.2 Example of the installation of the waterlock off-center and possible effects:

The following pictures are primarily relevant for an installation of the generator with the waterlock on sailing yachts. A change in the mounting position caused by tilted position does not have to be reckoned concerning motor yachts. Here it is only necessary to regard that the volume of the waterlock is measured so large that it can take the entire amount of water flowing back, and at the same time, maintains the minimum distance of 600 mm.

#### A) Installation of the waterlock 500 mm next to the generator's center line:

Fig. 6.7.3.2-1: waterlock, 500 mm next to the center line

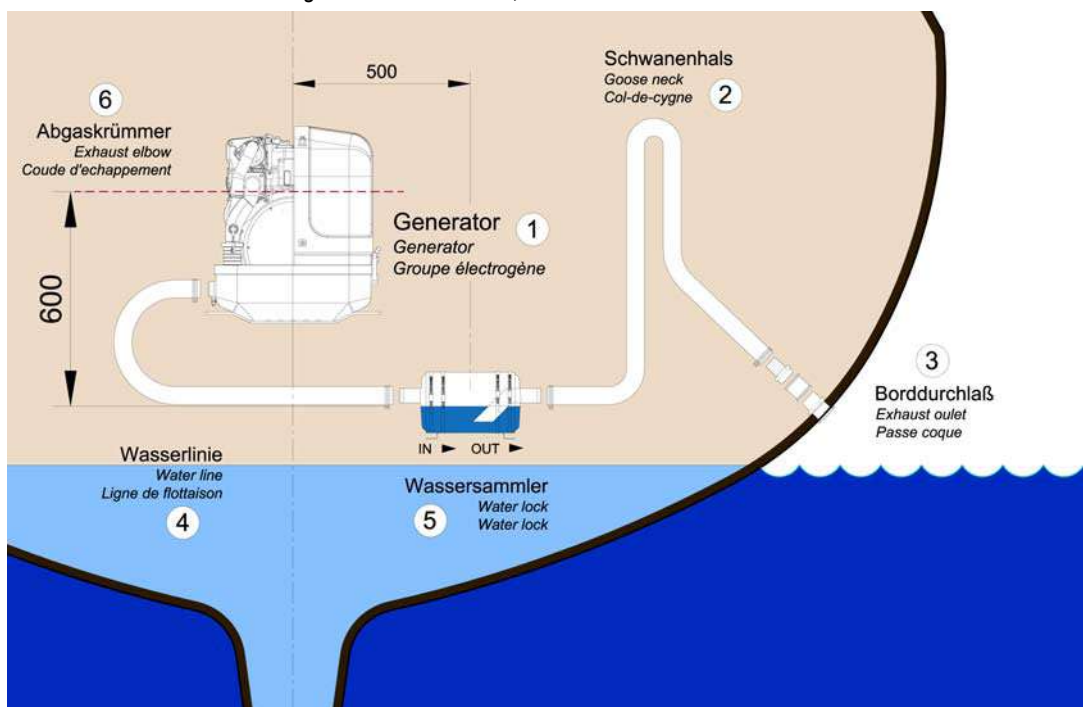
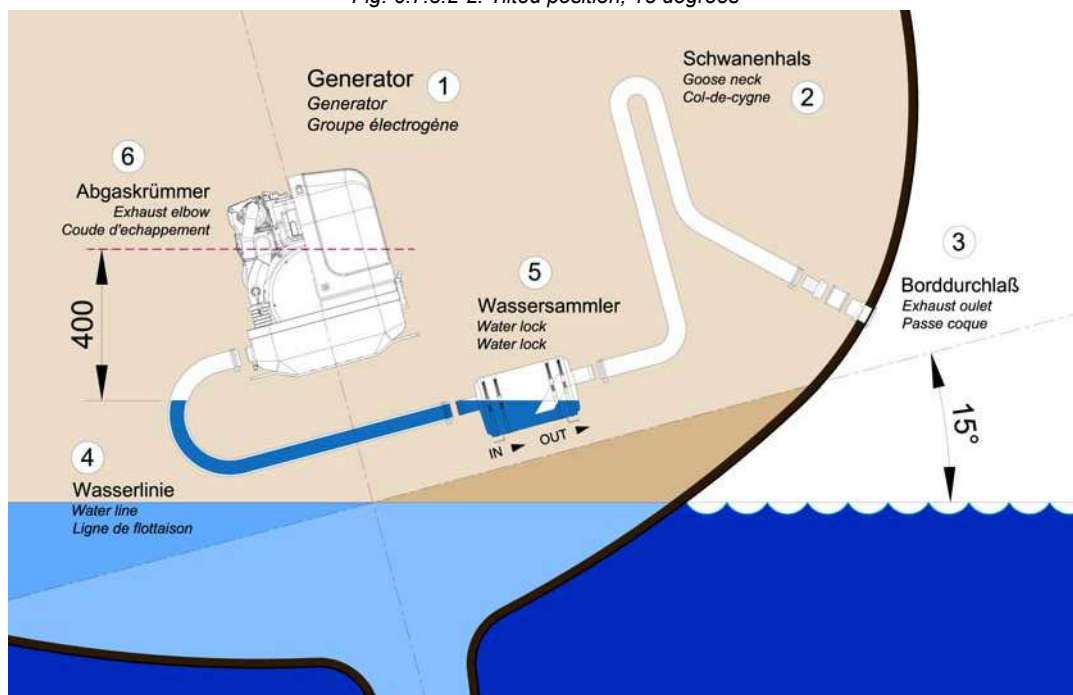


Fig. 6.7.3.2-2: Tilted position, 15 degrees

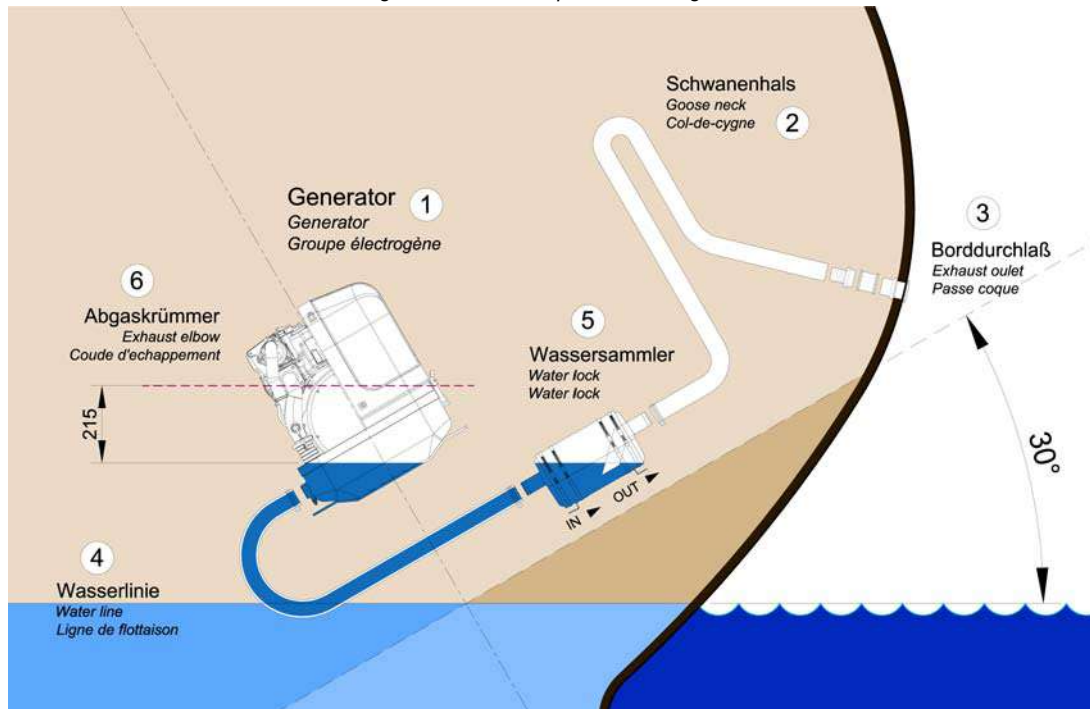


#### Tilted position 15 degrees - Fig. 6.7.3.2-2

The distance is only 404 mm instead of the original 600 mm. So this is very close to the critical point.



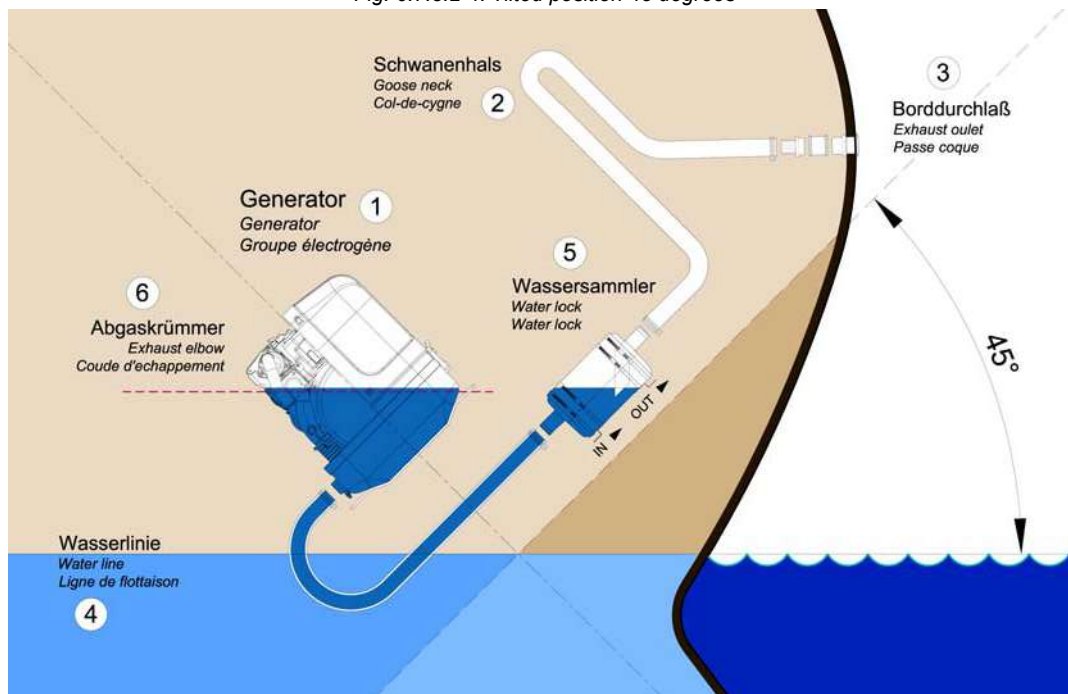
Fig. 6.7.3.2-3: Tilted position 30 degrees



### Tilted position 30 degrees - Fig. 6.7.3.2-3

The distance between the hydrostatic head and the critical point at the exhaust elbow is only 216 mm. This means that in a tilted position of 30 degrees you already face the highest risk of sea water sloshing into the combustion chamber.

Fig. 6.7.3.2-4: Tilted position 45 degrees



### Tilted position 45 degrees - Fig. 6.7.3.2-4

The water level is now at the same height as the critical point at the exhaust elbow. If the ship is sailed in a tilted position of 45 degrees with an installation like this, the ingress of cooling water into the combustion chamber is inevitable. Irreparable damages are pre-programmed.

**B) Installation distance between waterlock and the generator's center line 1000 mm**

Fig. 6.7.3.2-5: waterlock, 1000 mm next to center line

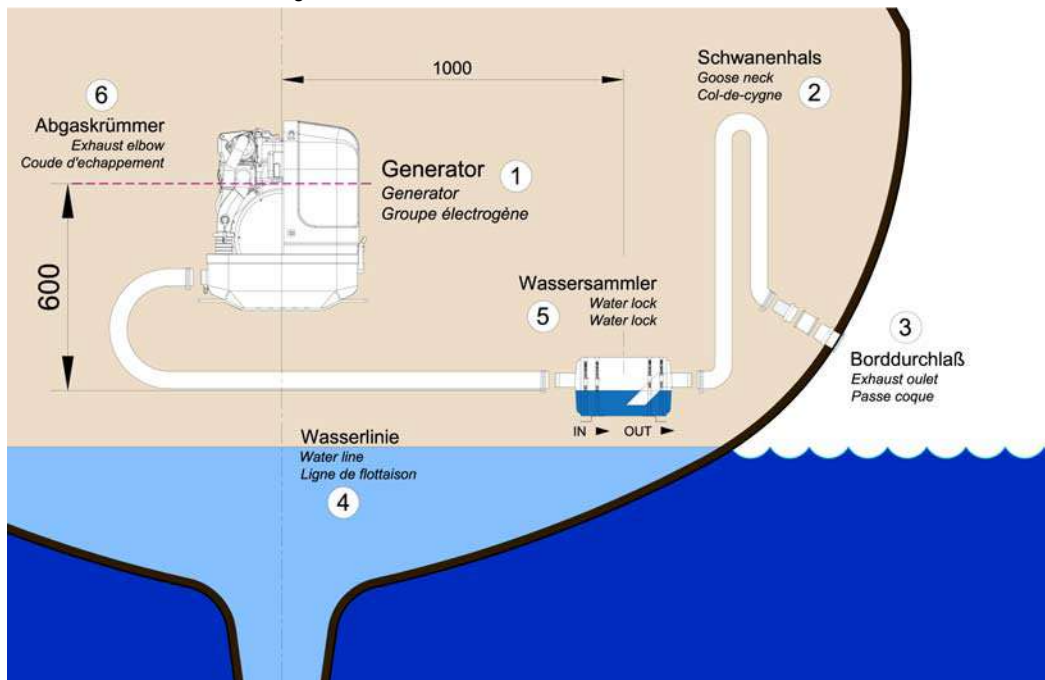
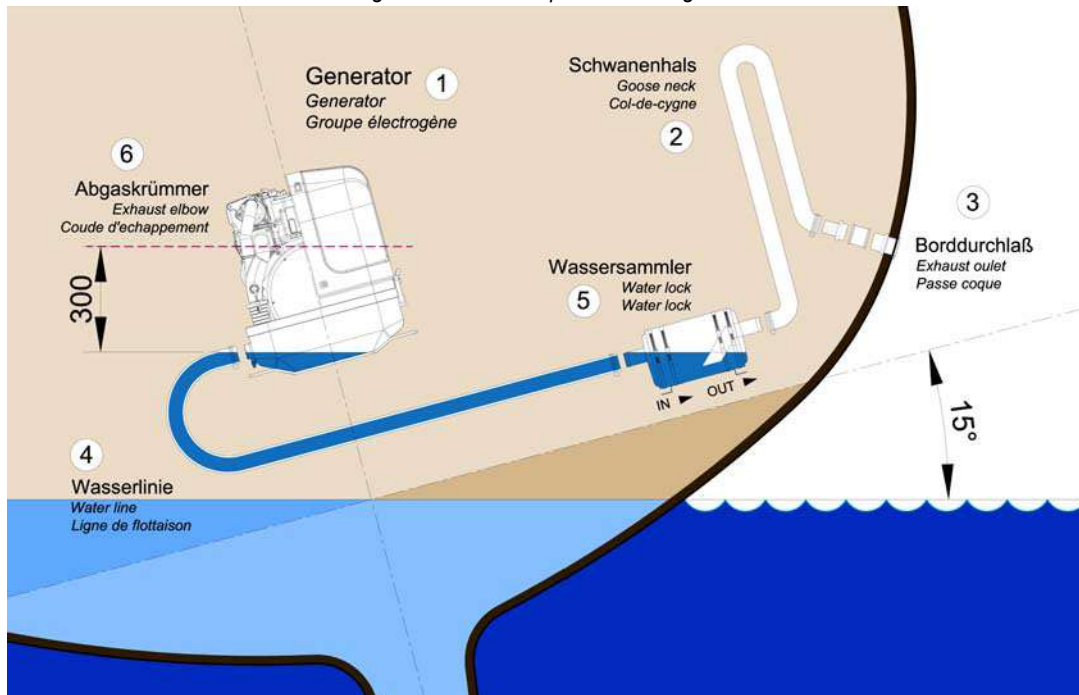


Fig. 6.7.3.2-6: Tilted position 15 degrees

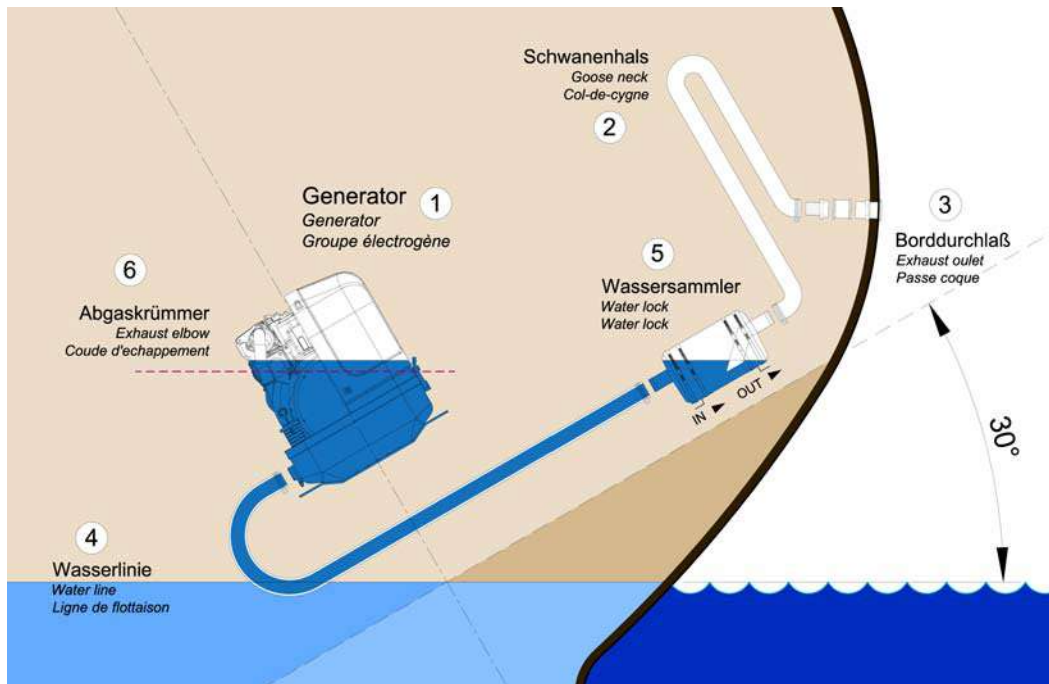


**Tilted position 15 degrees - Fig. 6.7.3.2-6**

The distance is, contrary to the original 600 mm, only 327 mm. This is very close to the critical point already.



Fig. 6.7.3.2-7: Tilted position 30 degrees



### Tilted position 30 degrees - Fig. 6.7.3.2-7

The water level and the critical point at the exhaust elbow are at the same level now. If the ship is sailed in a tilted position of 30 degrees with an installation like that, the infiltration of cooling water into the combustion chamber is inevitable. Irreparable damages are pre-programmed.

#### Summary:

Concerning sailing yachts it must be regarded, that the waterlock is mounted in center underneath the generator, at least in reference to the ships' center line. Thus the waterlock is prevented from „leaking“ very strongly when the ship is tilted.

The „leaking“ of the waterlock leads to a rise of the water level which then gets too close to the exhaust elbow's critical point.

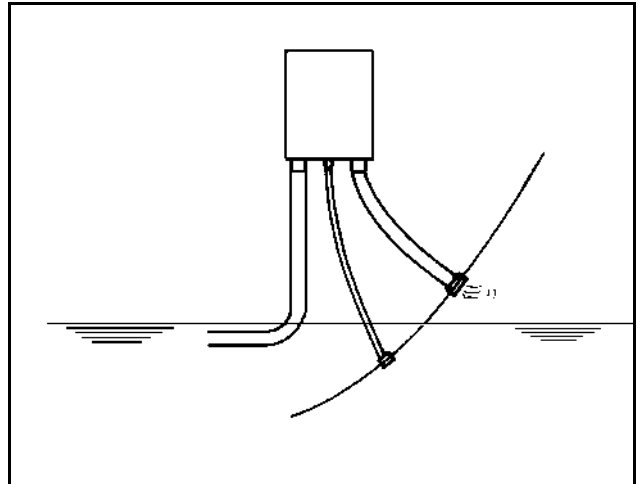
## 6.8 Exhaust / water separator

In order to reduce the noise level of the generator unit to a minimum, an optional exhaust outlet muffler can be mounted next to the through-hull fitting. Additionally there is a component at Fischer Panda, which acts as both an „exhaust goose neck“, and water separator. With this „exhaust/water separator“ the cooling water is derived over a separate pipe. The exhaust noises emanating from the exterior of the yacht are strongly decreased. Particularly the „water splash“.



**Water flow exhaust water Separator**

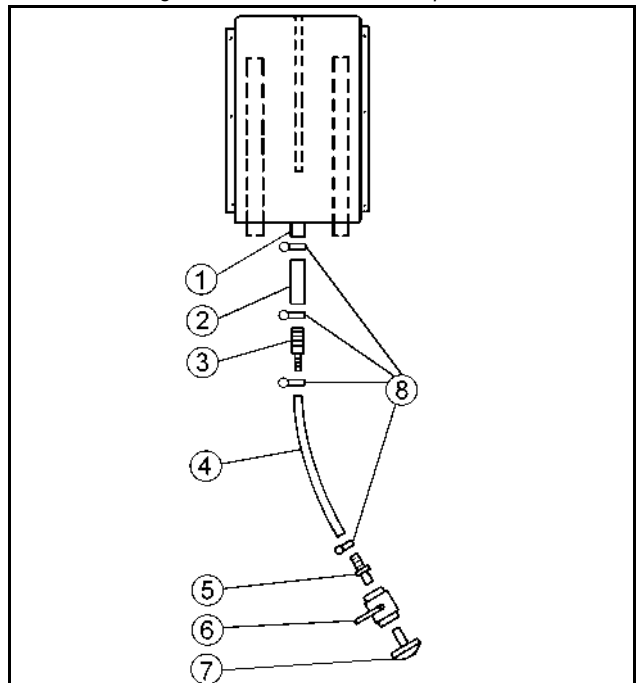
Fig. 6.8.0-1: Water Flow Exhaust Water Separator



**Water flow exhaust water Separator**

Fig. 6.8.0-2: Exhaust Water Separator

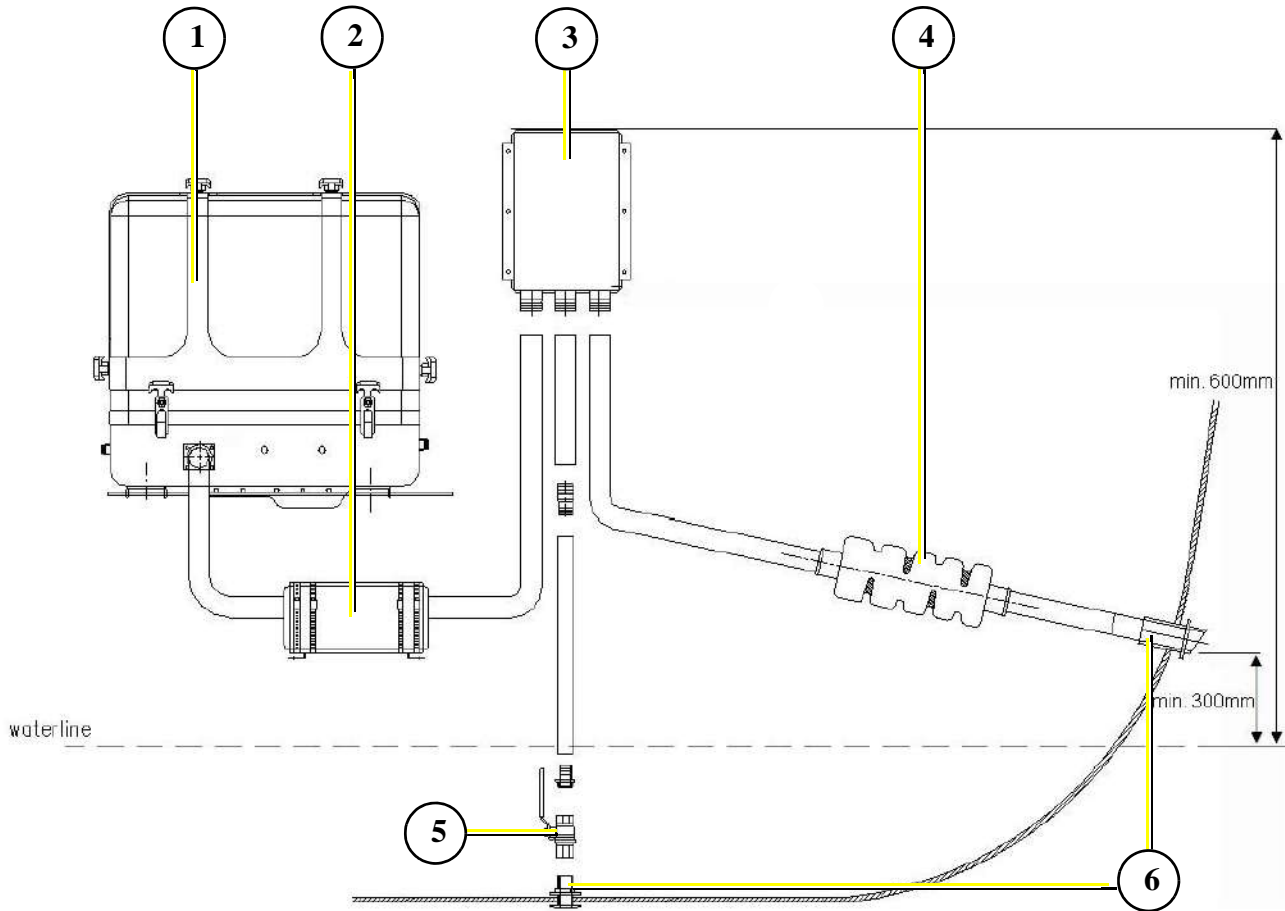
- (1) Raw water outlet
- (2) Hose connector
- (3) Reducer (if required)
- (4) Hose
- (5) Hose connector
- (6) Sea cock
- (7) Hull outlet
- (8) Hose Clips





### 6.8.1 Installation exhaust water separator

Fig. 6.8.1-1: Installation Exhaust Water Separator



- |                            |                |
|----------------------------|----------------|
| 1. Generator               | 4. Silencer    |
| 2. Silencer / Water lock   | 5. Sea cock    |
| 3. Exhaust-Water-Separator | 6. Hull outlet |

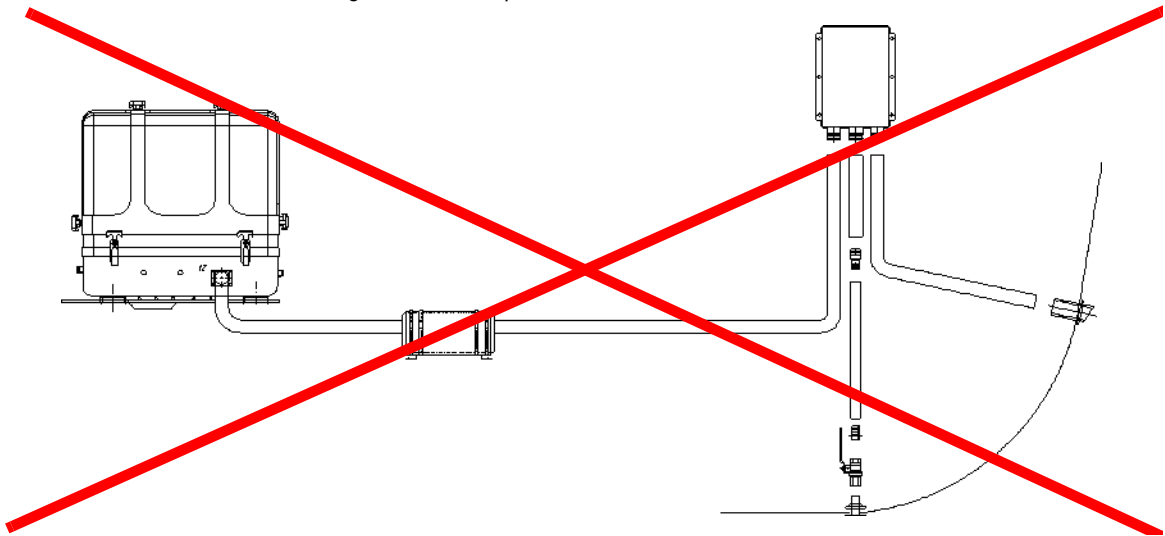
If the exhaust water separator was sufficiently highly installed, a goose neck is no longer necessary. The exhaust/water separator fulfils the same function. If the „Super silent“ exhaust system were installed correctly, the generator will not disturb your boat neighbour. The exhaust noise should be nearly inaudible. The best result is reached, if the hose line, which derive the cooling water, is relocate on a short way „falling“ directly to the outlet and this outlet is under the waterline.

If the through-hull exhaust outlet has to be mounted far from the generator, an exhaust-water separator must definitely be installed. The raw water from the separator must then run along the shortest possible path in the through-hull outlet. For such long exhaust routes, the exhaust hose diameter should also be increased, f.e. from NW40mm to NW50mm in order to reduce the back-pressure. The exhaust may have a length of over 10m (32 ft.) if the exhaust hose diameter is increased. An additional outlet exhaust muffler close to the hull outlet will help further to reduce noise emissions.

The generator will not disturb your boat neighbours, if the „Super silent Exhaust System has been correctly installed. The exhaust noise should be almost inaudible.



Fig. 6.8.1-2: Example for an unfavourable Installation



Example of an unfavourable installation:

- Water lock not far enough below the lowest level of the generator
- Distance water lock to exhaust/water separator too large

## 6.9 Installation of the fuel system

### 6.9.1 General references

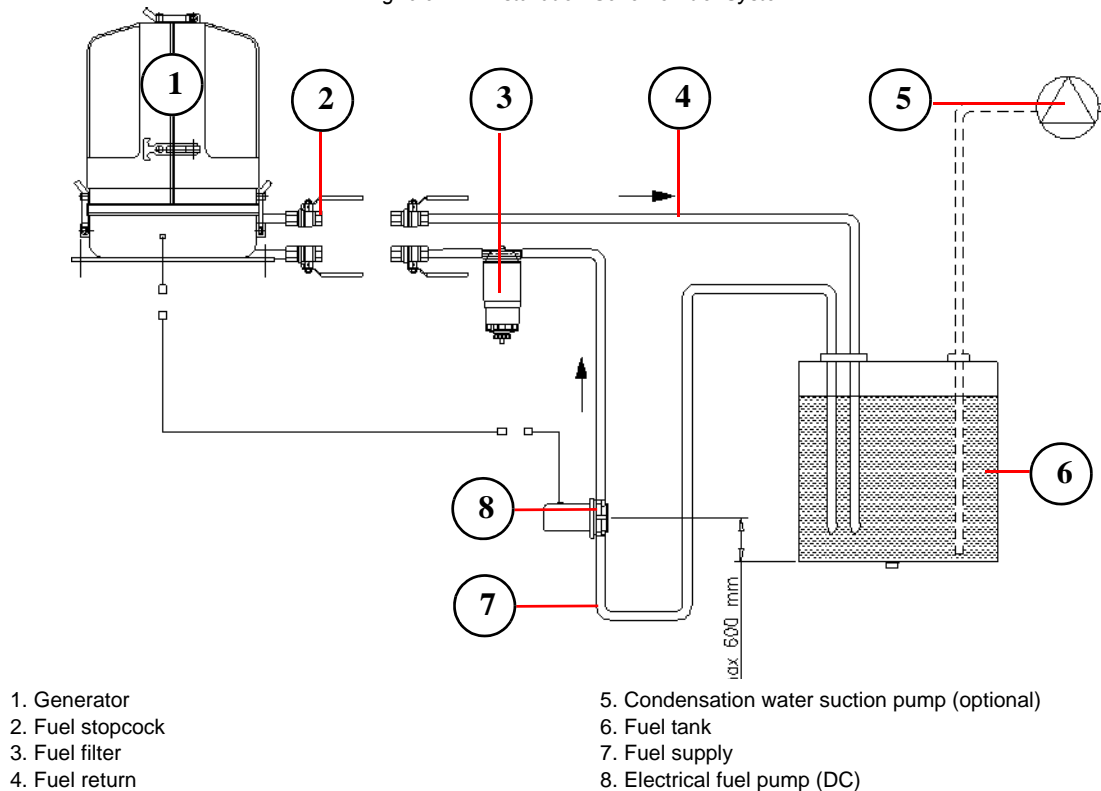
Inside the generator capsule itself, there is the fuel filter installed (exception: Panda 4200 and 4500). Additional fuel filters (with water separator) must be mounted outside the capsule in easily accessible places in the fuel lines between the tank intake fuel pump and the diesel motor's fuel pump.

Generally forward and return fuel flow pipes must be mounted to the diesel tanks. Do not connect the generator fuel supply lines with any other fuel lines of other diesel systems.

- The following items need to be installed:
- Fuel supply pump (DC)
- Pre-filter with water separator (not part of the delivery)
- Fine particle fuel filter
- Return fuel line to fuel tank (unpressurized)

The fuel supply pump should be mounted as close to the fuel tank as possible. The electric cable for the fuel pump is already installed on the generator (length 5 m).

Fig. 6.9.1-1: Installation Scheme Fuel System







## 6.9.2 The Electrical Fuel Pump

### Electrical fuel pump

With the Panda generator is usually supplied an external, electrical fuel pump (DC). The fuel pump must be installed close at the fuel tank. The electrical connections are pre-loaded at the generator with the lead planned.

*Suction height of the pump: max. 1,2 m at 02, bar*

*Diameter of fuel lines: section 9.10, "Diameter of conduits," on page 207.*

Fig. 6.9.2-1: Electrical Fuel Pump



## 6.9.3 Connection of the fuel lines at the tank

### Lead the return fuel pipe connected to the day tank to the floor

The return pipe connected to the tank must be dropped to the same depth as the suction pipe, if the generator is mounted higher than the tank, in order to prevent fuel running back into the tank after the motor has been switched off, which can lead to enormous problems, if the generator is switched off for a long period.

### Non-return valve in the suction pipe

A non-return valve must be fitted to the suction pipe, which prevents the fuel flowing back after the generator has been switched off, if it is not possible to use the return flow pipe as a submerge pipe placed in the tank. The instructions „Bleeding Air from the Fuel System“ must be read after initial operation or after it has stood still for a long period, in order to preserve the starter battery.

### Non-return valve for the fuel return pipe

If the fuel tank should be installed over the level of the generator (e.g. daily tank), then a non-return valve must be installed into the fuel return pipe to guarantee that through the return pipe no fuel is led into the injection pump.

### ATTENTION!





### 6.9.4 Position of the pre-filter with water separator

Additionally to the standard fine filter a pre-filter with water separator must be installed outside of the sound insulation capsule in the fuel system line (not included in the delivery).

Fig. 6.9.4-1: Pre-filter with water separator



### 6.9.5 Ventilating air from the fuel system

Normally, the fuel system is designed to vent air itself i.e. as soon as the electric starter motor starts; the fuel pump starts working and the fuel system will be air-vent automatically after some time. It is, nevertheless essential, to vent the system as follows prior to the first operation (as all hoses are empty):

1. Switch main power switch on control panel „ON“.
2. Push failure bypass switch and hold tight.

The electric fuel pump has to be run audibly. By moving the failure bypass switch you can hear the solenoid valve of the generator starting and stopping (when the sound insulation cover is taken off).

3. After the fuel pump has been running 3 to 4 minutes, because the failure bypass switch has been pressed down, the bleeding screw of the solenoid valve has to be unscrewed. The switch has to be continuously depressed, when opening the screw. A piece of cloth or absorbent paper should be put under the connection to avoid fuel entering the sound insulation cover.

4. The air vent screw can be screwed in again, as soon as fuel runs out without bubbles. Then release the depressing the failure bypass switch.

5. Starting the generator

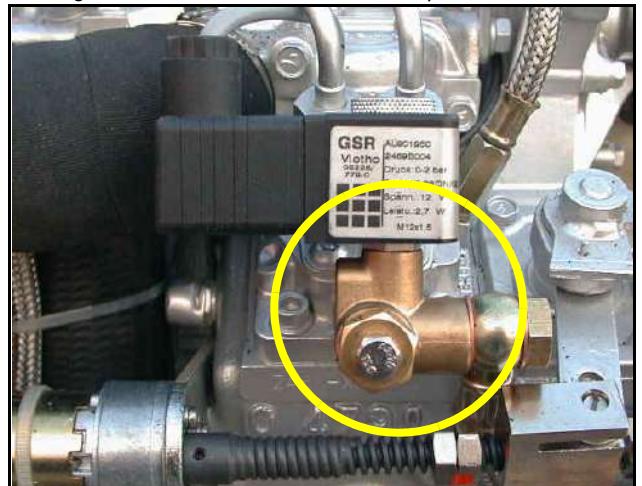
Now the generator can be started by pushing the „START“-button. The generator should start after a short while. One of the pipe union nuts of an injection hose has to be unscrewed, should the unit not start; then try to restart the generator. After the generator has started, the pipe union nut has to be tightened again.

Main power switch „OFF“

**Vent Screw at the fuel stop solenoid valve**

*Not installed at all models!*

Fig. 6.9.5-1: Vent Screw at the Fuel Stop Solenoid Valve



## 6.10 Generator DC system installation

The Panda generators from 6.500 NE upwards have their own dynamo to charge a DC starter battery.

It is recommended to install an additional starter battery for the generator.

The generator is then independent from the remaining battery set. This enables you to start the genset at any time with its own starter battery even if the other batteries are discharged. A further advantage of a separate starter battery is that it isolates the generator's electric system from the rest of the boat's DC system, i.e. minus pole (-) is not connected electrically to Earth/Ground.

The generator is then Earth/Ground free.

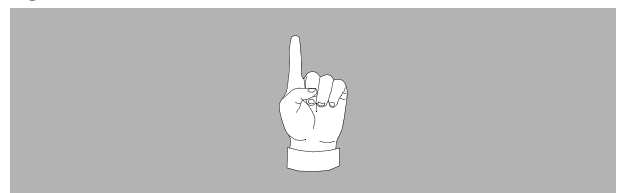
### 6.10.1 Connection of the starter battery block

An own separate starter battery must be installed for the generator.

The positive cable (+) of the battery is attached directly at the solenoid switch of the starter motor (position 1). The negative cable (-) of the battery is attached underneath the starter motor at the engine mount (position 2).

**Panda Generators Panda 6000 and higher normally provided with an alternator/dynamo to charge the starter battery. At generators without alternator/dynamo it is needed to charge the starter battery with an external battery charger.**

**NOTE:**



**Make sure that the voltage of the starter battery fits to the start system voltage**

**ATTENTION!**



f.e. 12 V starter battery for a 12 V start system

f.e. 24 V starter battery for a 24 V start system (2x12 V batteries in a row)

To avoid large voltage drops the battery should be installed as near as possible to the generator. The positive terminal of the battery is attached at the red cable, the negative pole at the blue cable.

It must be guaranteed that first the cables are attached at the generator and then at the battery.

#### Battery connection

Wrong connection of the battery bank can cause a short-circuit and fire.

Install an appropriate fuse and a battery circuit breaker in the plus pole cable of the battery, but with a distance to the battery of up to 300 mm (12 inch) at maximum.

The cable from the battery to the safety device must be secured with protective pipe/sleeve against chafing through.

For the connection use self-extinguishing and fire-protected cables, which are appropriate for temperatures up to 90 °C, 195 °F.

The batteries must be installed in such a way that they do not chafe through or other mechanical load can be stripped.

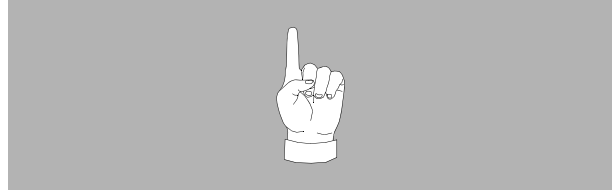
The battery poles must be secured against unintentional short-circuit.

The positive battery cable within the generator must be shifted in such a way that it is protected against heat and vibrations by appropriate sleeve/protective pipe. It must be shifted in such a way that it does not affect rotary parts or parts, that become hot in operation, e.g. wheel, exhaust elbow union, tail pipe and the engine. Do not lay the cable too tautly, since otherwise it could be damaged.

Make a test run after the installation and check the laying of the batteries during the test run and afterwards. If necessary, correct the laying.

Examine regularly the cable laying and the electrical connections.

#### NOTE:



#### Attention!: Consider correct connection sequence



#### Attention!: Right connection of the battery.



## Positive battery cable

The positive (+) battery cable is connected directly to the solenoid switch of the starter.

Fig. 6.10.1-1: Positive Battery Cable

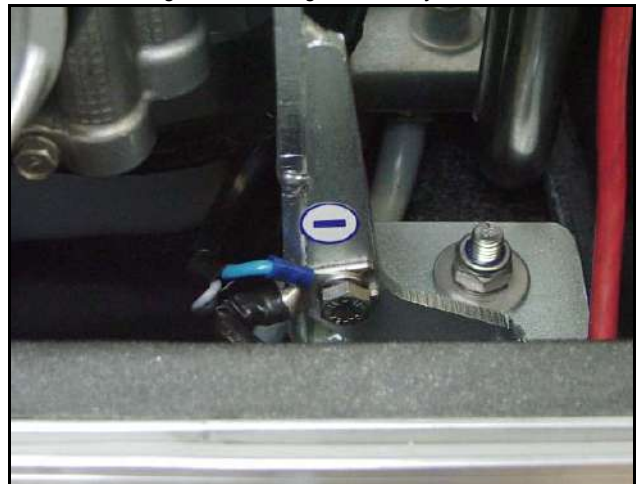


## Negative battery cable

The negative (-) battery cable is connected to the engine foot.

**Note!** The battery negative pole may not be connected with the boat ground or with the protective grounding of the 120 V installation!

Fig. 6.10.1-2: Negative Battery Cable



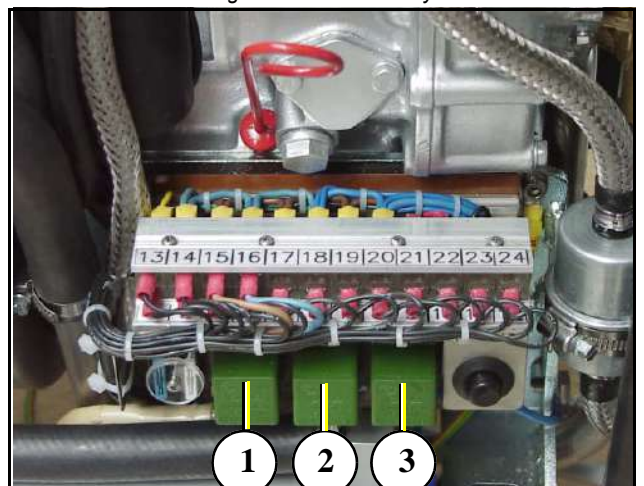
## DC-Relay

The Panda generators 8000 to 30 are equipped with various DC-relays, which can be found under the terminal strip. The various relays have the following tasks (also see the DC circuit diagram)

1. Starter motor relay
2. Pre-glow relay (glow plugs)
3. Fuel pump relay

Sample Picture - See wiring diagram

Fig. 6.10.1-3: DC-Relay



### DC Starter Motor

All Panda generators are equipped with an independent DC starter motor.

1. Solenoid switch for starter motor
2. Starter motor

Fig. 6.10.1-4: DC Starter Motor

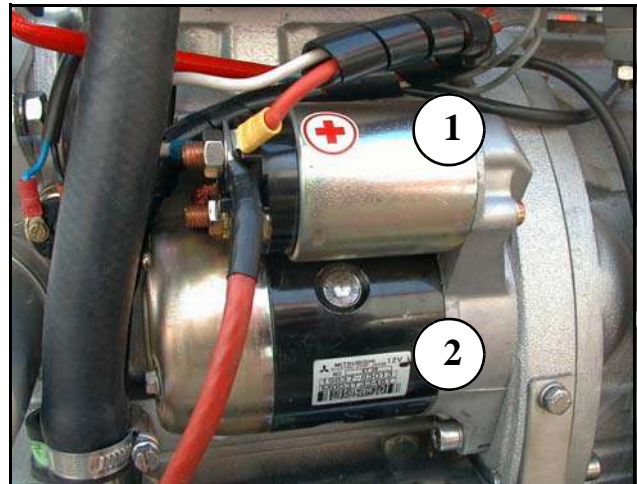
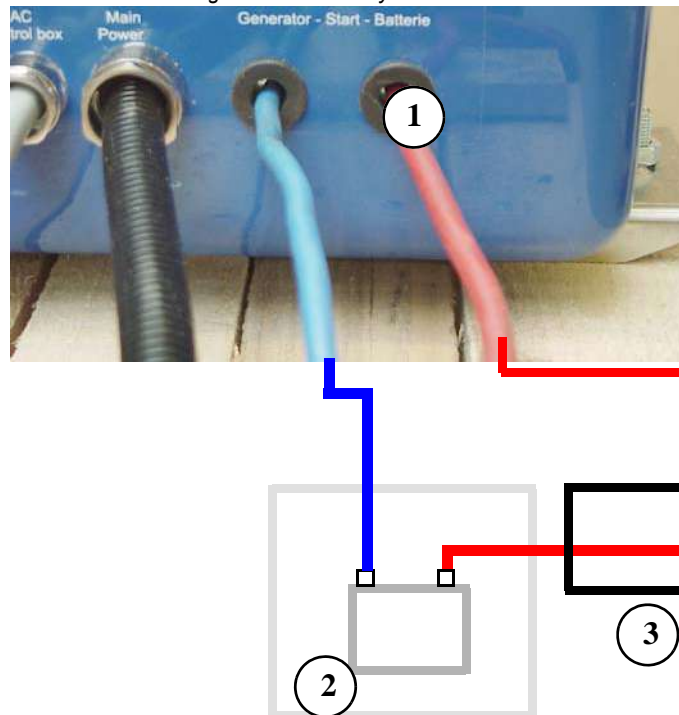


Fig. 6.10.1-5: Battery installation - Scheme



1. Generator
2. Battery block

3. Fuse
4. Battery main switch

### 6.10.2 Connection of the remote control panel - see separate control panel manual



## 6.11 Generator AC System Installation

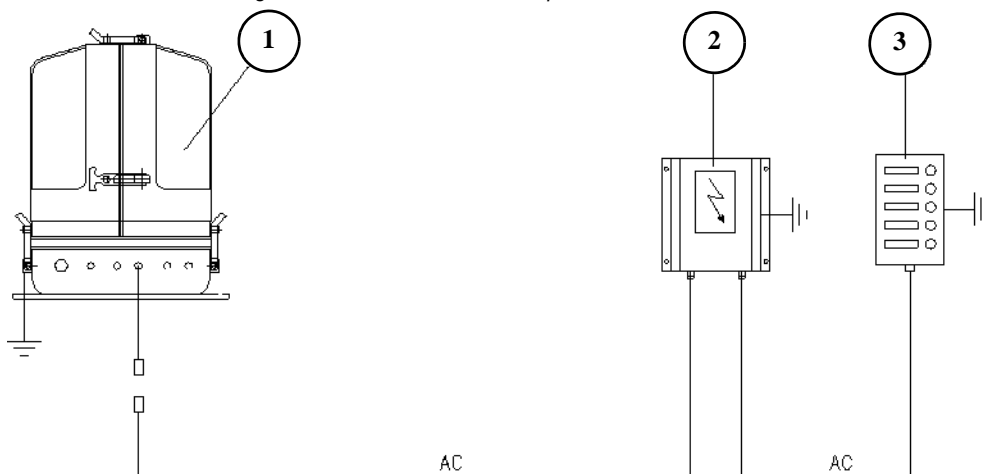
Before the electrical system is installed, READ the SAFETY INSTRUCTIONS of this manual FIRST! Be sure that all electrical installations (including all safety systems) comply with all required regulations of the regional authorities. This includes lightning conductor, personal protection switch etc.

**ATTENTION!**



### 6.11.1 Installation with looped in AC-Control box

Fig. 6.11.1-1: Installation with looped in AC-Control box



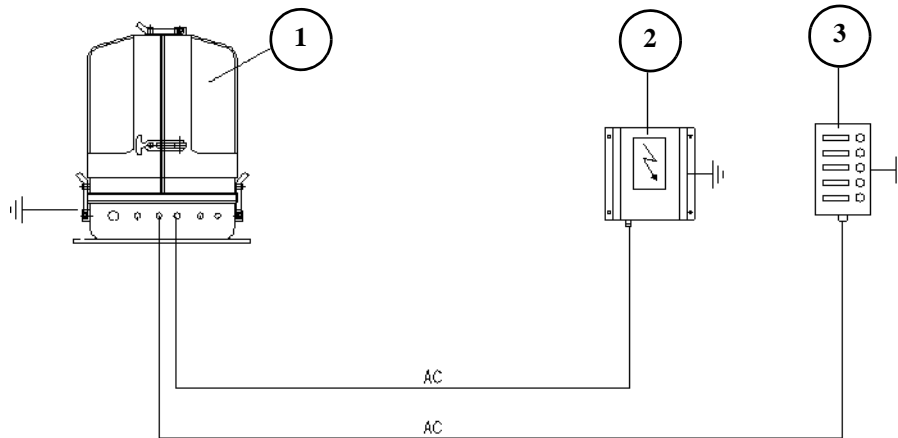
- 1. Generator
- 2. AC-Control Box

- 3. Distribution panel

**All electrical safety installations have to be made on board.**

## 6.11.2 Installation AC-Box / distribution panel separate connected

Fig. 6.11.2-1: Installation AC-Box / distribution panel separate connected



1. Generator
2. AC-Control Box

3. Distribution panel

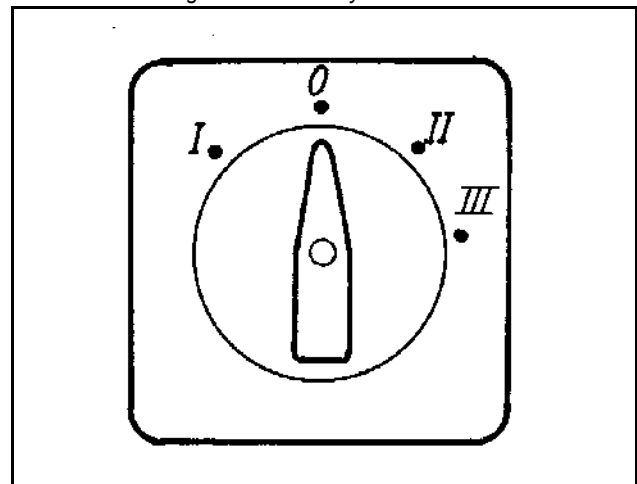
A power source selector switch must be installed between the generator (or if applicable, AC-Control box) and the ship's electrical supply system. This switch must be used to ensure that all AC consumers can be switched off at once. This switch should also be installed to keep the generator and shore (grid) power systems separate.

### 3-Way Cam Switch

A 3-way cam switch should be used. This switch basic positions: „Shore power“ - „OFF“ - „Generator“. If an (DC-AC) inverter is used, a fourth position will be required.

0. OFF
- I. Generator
- II. Shore power connection
- III. Inverter

Fig. 6.11.2-2: 3-Way Cam Switch



The cam-type switch must have 2 poles, so that „MP“ and „phase“ can be switched off.

If a 3-phase current system is also installed with the option of supplying from either the generator or shore power, an additional switch must be installed to keep these systems separate.

An alternative to a manual rotating switch is an automatic power relay. When the generator is not running, the relay remains in the shore power position. As soon as the generator is running, the power relay switches automatically to the generator position.

**Note: If the system has both single and 3-phase AC, it is CRITICAL that the two systems remain SEPARATE!**

### Protection conductor

The generator is provided with a PEN safety system, as standard, which connects the 3-phase delta centre point „N“ to the safety ground strap.

If a separate ground protection cable is necessary (i.e. due to national safety regulations), the bridge between the





generator housing and ground (in the AC-Control box) must be disconnected. Once such a ground protection cable is installed, it must be connected to the ground straps of all on board electrical devices.

In order to monitor the electrical system, it is recommended to install a voltmeter (and, if possible, a current meter) down line from the power source selector switch so that all respective power sources can be monitored. A separate voltmeter for the generator, itself, is therefore not required.

### **Electrical fuses**

It is absolutely essential that the electrical system installation is inspected by a qualified electrical technician. The generator should have its own AC input electrical fuses. The fuses should be sized such that the rated current of the generator on each of the individual phases is not exceeded by more than 25%.

Data for gensets with power output greater than 30 kW on request!

The fuses must be of the slow type. A 3-way motor protection switch must be installed to protect the electrical motor.

*Required fuses see rated current on the type plate*

### **Required cable cross-sections**

*The following recommended electrical cable dimensions (cross sections) are the minimum required sizes for a safe installation. (see "Cable cross section" on page 200.)*

### 6.11.3 AC-Control Box with VCS and ASB - not all models

The required capacitors for the excitation of the generator are located in the AC-Control box, as well as the electronic control for voltage/speed regulation (VCS) and the starting current re-enforcement (ASB). The AC-Control box must be connected by electrical wires (high voltage and low-voltage) to the generator.

The front panel must always be closed, since the AC-Control box produces 400 V during operation.

**The AC-Control box must be electrically connected to the generator (high and low voltage).**

**ATTENTION!** Before working on the System read the „Section Safety Instructions in this Manual“.

**Danger - High voltage**



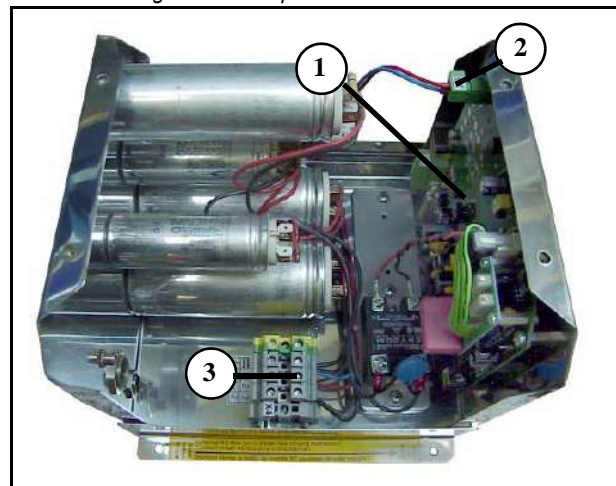
#### AC-Control Box

Inlet VCS-connection (X1)

Inlet measuring voltage (X3)

Excitation cable to generator (X4)

Fig. 6.11.3-1: Opened AC Control Box



#### AC-Control Box - from Panda 30 upwards

Fig. 6.11.3-2: Opened AC Control Box from Panda 30 upwards



### 6.11.4 VCS voltage control

All Panda generators from Panda 8000 upwards are fitted with the electronic voltage control „VCS“ as standard.

The VCS controls the generator voltage and motor speed. A actuator on the injection pump can increase the engine speed by up to 8%.

If the generator is run without load, the voltage should be 231V with a frequency of approximately 48.5 to 49Hz. The frequency (equates to the speed) can be increased by up to 8%. This ensures that the engine speed is increased when there is an extra load. The maximum speed is achieved when 80% load is reached.

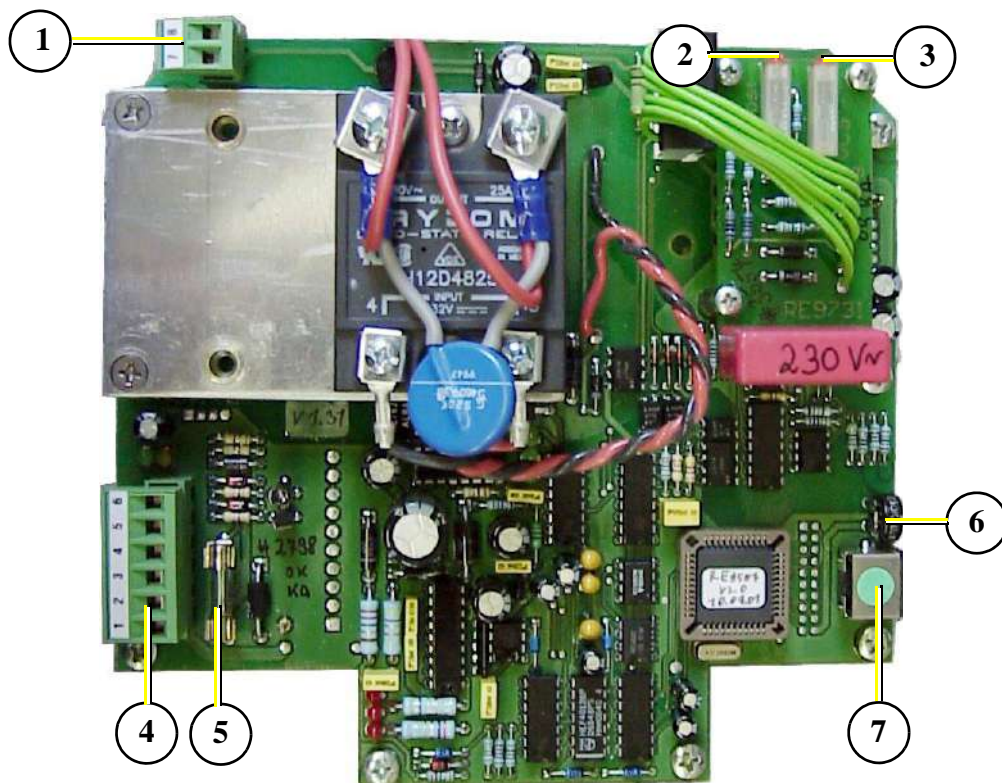
The speed gauge is governed by an adjusting screw, above and below. Adjustment of this screw may not occur without the expressive approval of the manufacturer.

All signals pass through the circuit board in the AC-Control box. The signal impulse for the actuator is passed to the electric motor by means of the 5 core wire.

The generator maintains its full capability if the VCS has a defect.

In this case the base current must be raised to at least 240 V by adjusting the minimum setting on the speed gauge, in order to ensure that the generator output voltage at 70% nominal load does not drop below 215 V.

Fig. 6.11.4-1: VCS Control



- |  |   |
|--|---|
| <ul style="list-style-type: none"> <li>1. Connection measuring voltage</li> <li>2. Adjusting booster voltage (do not adjust!)</li> <li>3. Adjustment VCS-voltage</li> <li>4. Connection VCS inlet</li> </ul> | <ul style="list-style-type: none"> <li>5. Electrical fuse (1.6 A, slow to blow)</li> <li>6. Potentiometer for booster time</li> <li>7. Connection for PC</li> </ul> |
|--|---|

### 6.11.4.1 Alternative Mini VCS

Alternative for generators without AC control box the Mini VCS.

The Mini VCS and the capacitors are mounted at the generator.

#### Mini VCS at the Panda 6500 NE PMS

Fig. 6.11.4.1-1: Mini VCS at the Panda 6000 ND PMS



#### Capacitors at the Panda 6500 NE PMS

Fig. 6.11.4.1-2: Capacitors at the Panda 6000 ND PMS

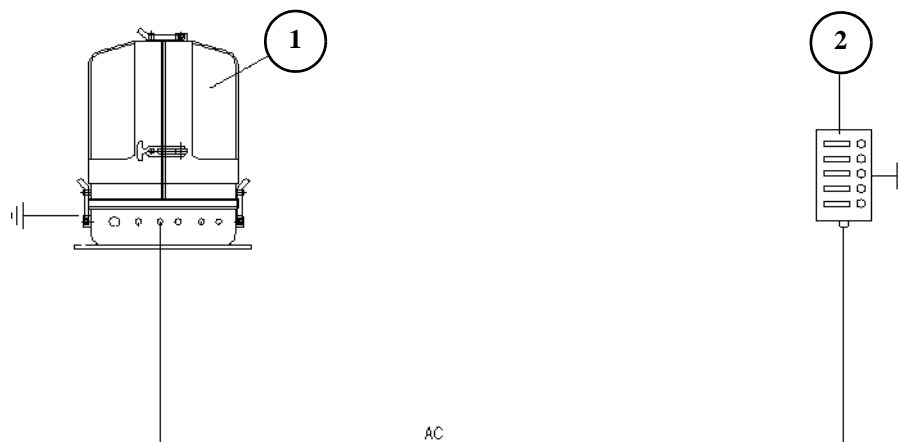


**Note:**

*The Mini VCS has no internal fuse.*

### 6.11.5 Installation with mini VCS mounted at the generator

Fig. 6.11.5-1: Installation with mini VCS mounted at the generator



1. Generator

2. Distribution panel

All electrical safety installations have to be made on board.

### 6.11.6 Jump start at high starting current (Booster)

Additionally, the automatic start booster is located on the circuit control board. The starting current is increased by connecting a second group of capacitors (C2), if the voltage drops below a pre-set voltage. The starting current can be increased by 300% for a short period by combining both components voltage/speed control and ASB Start booster.

### 6.11.7 Insulation test

---

Once the electrical system installation is complete, a ground insulation test must be performed as follows:

**ATTENTION:**



- 1.) Switch off all on-board electrical devices.
- 2.) Start the generator.
- 3.) Measure the AC-voltage with a voltmeter (adjust to Volt/AC) between
  - a) generator housing and AC-Control box
  - b) generator housing and ground.

The measured voltage must not exceed 50mV (millivolts).

7. Once the safety systems have been installed, they must be checked. If a RCD (Leakage Current Relay) has been installed, it also has to be tested, in order to ensure that it functions properly. The individual phrases must be checked against each other, and between phase and ground, (the single phase or 4th phase also needs to be checked in this fashion).
8. If the generator is protected by a ground connection, then ALL electrical devices must also be connected to this „common“ ground (usually ground contacts are attached to the devices' metallic housings).

The electrical system installation must also comply with the hook-up requirements of the shore current grid. Generally a leakage current relay is sufficient for safe electrical operation; however, this must be confirmed by the electrical safety standard in the region where the system is attached to a main land power grid. The relay has to meet the required safety standard regulations.

#### **Checking the electrical connections**

There is always the possibility that circuits have been rerouted/changed or individual components have not been not been correctly laid out on the circuit diagrams.

The installation electrician should therefore check and label all electrical connections to ensure that they correspond to the main circuit diagram. The inspection and correct labelling is especially critical for terminals L1/ L2/L3/L1'/N (for the 230 V - 50 Hz model) and for terminals L1/L2/L3/N & 1/ 2/ 4 for the 60 Hz (120 V) models. The electrician is therefore obliged, before installation to check whether the generator is earth-free. As long as this test has not been carried out all other components for electrical installation must be removed. Once the system has been installed and inspected, this test should also be performed with all electrical devices (i.e. voltage check between common and metallic housings) while the generator is running.



## 7. Maintenance Instructions

### 7.1 Personal requirements

---

All maintenance, if not special marked, can be done by the trained persons.

Further maintenance must be done by technical personal or Fischer Panda service points.

### 7.2 Hazard notes for the maintenance

---

Follow the general safety instruction at the front of this manual.

Notice!



**Danger for life! - The generator can be equipped with a automatic start device. This means the generator can be started by an external signal. To avoid an unexpected starting of the generator, the starter battery must be disconnected before start working at the generator.**

Warning!: Automatic start



**Working at a running generator can result in severe personal injury. Therefore before starting work at the generator:**

Warning!: Risk of injury



Make sure that the generator is stopped and the starter battery is disconnected to guarantee that the generator cannot be inadvertently started.

Do not run the generator with removed sound isolation cover

**Improper installation/maintenance can result in severe personal injuries or material damage.**

Warning!: Risk of injury



- Always undertake installation/maintenance work when the generator is switched off.
- Ensure there is sufficient installation clearance before start working.
- Ensure tidiness and cleanliness at the workplace. Loose components and tools lying around or on top of each other are sources of accidents.
- Only perform installation work using commercially available tools and special tools. incorrect or damaged tools can result injuries.

**Oil and fuel vapours can ignite on contact with ignition sources. Therefore:**

- No open flames during work on the generator.
- Do not smoke.
- Remove oil and fuel residues from the generator and floor.

**Contact with engine oil, antifreeze and fuel can result in damage to health. Therefore:**

- Avoid skin contact with engine oil, fuel and antifreeze.
- Remove oil and fuel splashes and antifreeze from the skin immediately.
- Do not inhale oil and fuel vapours.

**Danger for Life. Improper handling, operation, installation and maintenance can result in severe personal injury and/or material damage.**

Electrical voltages above 48 volts (battery chargers greater than 36 volts) are always dangerous to life). The rules of the respective regional authority must be adhered to. Only an electrician may carry out installation of the electrical connections for safety reasons.

**Generator, oil and antifreeze can be hot during/after operation. Risk of severe burns.**

**During Installation/maintenance personal protective equipment is required to minimize the health hazards.**

- Protective clothing
- safety boots
- protective gloves
- Ear defender
- safety glasses

**Disconnect all load during the work at the generator to avoid damages at the load.**

**Batteries contains acid or alkalis.**

Improper handling can result in battery explosion and leakage. Acid or alkalis can run out. An explosion of the battery is possible.

*See the operation and safety instruction from your battery*

**Warning!: Danger of fire**



**Danger!: Danger of poisoning**



**ATTENTION!: Danger to Life - High voltage**



**Warning!: Hot surface/material**



**Instruction!: Personal protective equipment necessary.**



**Attention!: disconnect all load**



**Warning!:**







manufacturer.

Batteries contain corrosive acids and lyes. Improper handling can cause the batteries to heat up and burst. Corrosive acid/lye may leak. Under unfavorable conditions, the battery may explode.

Observe the instructions from your battery manufacturer.

## 7.3 Environmental protection

---

### Danger to the environment due to mishandling!

Significant environmental damage can occur, particularly for incorrect disposal, if environmentally hazardous operating materials are mishandled. Therefore:

- Always observe the instructions mentioned below.
- Take immediate action if environmentally hazardous materials reach the environment. Inform the responsible local authorities about the damage in the case of doubt.

*The disposal must be performed by a specialist disposal company.*

### Environmental protection.



## 7.4 Maintenance interval

---

For the maintenance interval, please see the „General information for PMS generators“ which are attached to this manual.

At generator with dynamic operation hours (f.e. Generators with iControl2 system) the maintenance interval can may be extended.

With the dynamic operation hours the service interval can be raised up to 30 % (200 h max.). Make sure that the dynamic operation hours are not reset accidentally between the service interval.

### Note:



## 7.5 General maintenance instructions

---

### 7.5.1 Checks before each start

---

- Oil level
- Leaks in the Cooling system
- Visual check for any changes, leaks in the oil drain system, v-belt, cable connections, hose clips, air filter, fuel lines

#### Once a month

- Grease/oil the servo motor - Trapezoid thread-spindle

Maintenance intervals - see separate data sheet



### 7.5.2 Check of Hoses and rubber parts in the sound insulated capsule

---

Check all hoses and hose connections for good condition. The rubber hoses are very sensitive to environmental influences. They wear out quickly in an environment of dry air, oil and fuel vapours, and high temperatures. The hoses must be checked regularly for elasticity. There are operating situations, when hoses must be renewed once a year.

Additionally to usual tasks of maintenance (oil level check, oil filter control etc.) further maintenance activities are to be accomplished for marine generators, such as control of the sacrificial anode (cooling water connection block) and the front seal cover at the generator.

## 7.6 Oil Change Intervals

---

---

The first oil change is to be accomplished after a period of operation from 35 to 50 hours. Afterwards the oil is to be changed after 150 hours. For this, the oil SAE30 for temperatures over 20°C and SAE20 for temperatures between 5°C and 20°C is to be used. At temperatures under 5°C oil of the viscosity SAE10W or 10W-30 is prescribed.

For filling quantity, see „Technical Data“ at page 107.

## 7.7 Checking oil-level

---

---

**You require:**

**paper towels / cloth for the oil dipstick**

The generator must be placed at level.

- with vehicular generators: Place the vehicle on a levelled surface.
- with PSC generators: Place the generator on a levelled surface.
- with marine generators: Measure the oil-level when the ship is not lop-sided.

Run the generator for about 10 minutes to ensure that the engine is warm. Wait for 3 minutes, so the oil can flow back into the oil pan.

**Generator and coolant can be hot during and after operating.**

**Caution: Burn hazard!**

Wear personal protective equipment. (Gloves, protective goggles, protective clothing and safety shoes)



- Assure generator against accidental start.
- Open the generator casing.
- Pull the oil dipstick out of the check rail.
- Clean oil dipstick.
- Put the oil dipstick back into the check rail and wait for 10 seconds.
- Pull the oil dipstick out of the check rail and read off the oil-level at the lower end of the stick.



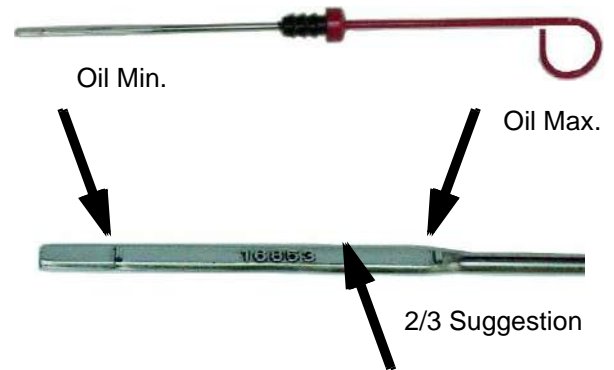
**Oil dipstick**

The oil-level is to be checked by means of the oil dipstick. The prescribed filling level must not cross the „Max“-mark.

*We recommend an oil-level of 2/3.*

*Sample picture*

Fig. 7.7-1: Oil dipstick - Sample



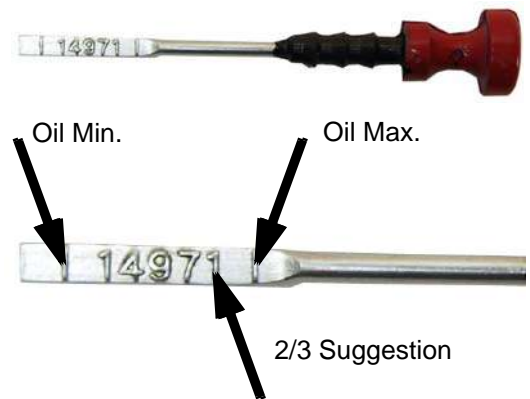
**Oil dipstick EA 300 Engine**

The oil-level is to be checked by means of the oil dipstick. The prescribed filling level must not cross the „Max“-mark.

*We recommend an oil-level of 2/3.*

*Sample picture*

Fig. 7.7-2: Oil dipstick



Oil should be refilled, if the oil-level is under 1/3 between the minimum and the maximum mark.

Fischer Panda recommends an oil-level of 2/3 between the minimum and the maximum mark.

If the oil-level is under the MIN-mark, check how many operating hours went by since the last oil change, by means of your service manual or an existing oil change tag. - with operating hours between 50 and 150 hours it is only necessary to refill oil. See „Refilling oil“ on page 2.

- with 150 operating hours or more the oil should be changed (See your generators' service table)
- if the oil-level is under the minimum mark by less than 50h, there might be a technical problem! In that case, we recommend going to a shop or a Fischer Panda service point.
- if the oil is cloudy or even „creamy“, coolant might have mixed with the oil. See a garage or a Fischer Panda service point immediately.

**7.7.1 Refilling Oil**

**You require:**

**Engine oil**

1. Check oil-level as described under section 7.7, “Checking oil-level,” on page 98.
2. Oil dipstick is pulled out of the check rail.
3. Open the oil filler cap.
4. Fill in oil (approx. 1/2 litre) and wait for about 2 min. so this it can flow into the oil pan.
5. Wipe off the oil dipstick and put it into the check rail.
6. Pull the oil dipstick out of the check rail and check the oil-level. See section 7.7, “Checking oil-level,” on page 98.

If oil-level is still too low (under 2/3): repeat steps 4-6.

### **7.7.2 After the oil level check and refilling the oil**

---

- Put the oil dipstick back into the check rail.
- Close the oil filling cap.
- Remove potential oil stains and splashes from the generator and surroundings.
- Close the generator casing.
- Remove lock against accidental generator start.

## **7.8 Replacement of engine oil and engine oil filter**

---

---

**You require:**

- Engine oil. See attachment.
- New oil filter (not with generators with EA300 engines)
- Sealing for oil drain screw
- Personal protective gear
- Container to collect used oil (heat resistant and of sufficient size)
- Open-ended wrench for oil drain screw
- Paper towels and cloth
- Oil filter wrench
- Oil resistant mat, so prevent used oil from getting into underground water

The generator must be placed at level.

- with vehicular generators: Place the vehicle on a levelled surface.
- with PSC generators: Place the generator on a levelled surface.
- with marine generators: Change the oil when the ship is not lop-sided.

Run the generator for about 10 minutes to ensure that the engine is warm.

Wait for 3 minutes, so the oil can flow back into the oil pan.

**Generator and coolant can be hot during and after operating.**

Wear personal protective equipment. (Gloves, protective goggles, protective clothing and safety shoes)

**Caution: Burn hazard!**



1. Prepare generator.

- Assure generator against accidental start.

- Open the generator casing.
- with generators that have an external oil drain hose: Release the oil drain hose from the mounting.
- with generators that have an internal oil drain hose: Open the lead-through for the oil drain hose (left turn of the sealing). Pull out the sealing with the oil drain hose.

Place an oil resistant mat under the oil drain hose area and prepare the container.

## 2. Loosen oil filling cap

Unscrew the oil filling cap. This is necessary, because otherwise a vacuum will form and the oil can not completely drain off.

Sample picture

Fig. 7.8-1: Oil filling cap



## 3. Open oil drain screw.

Unscrew the oil drain screw by means of the open-ended wrench from the oil drain hose (rotating direction left). Use a second open-ended wrench to lock. Make sure to do this over the container.

Use spanner size 17 mm.



Fig. 7.8-2: Oil drain hose



## 4. Discharge used oil.

Let the entire amount of oil drain out of the engine. This can take several minutes.

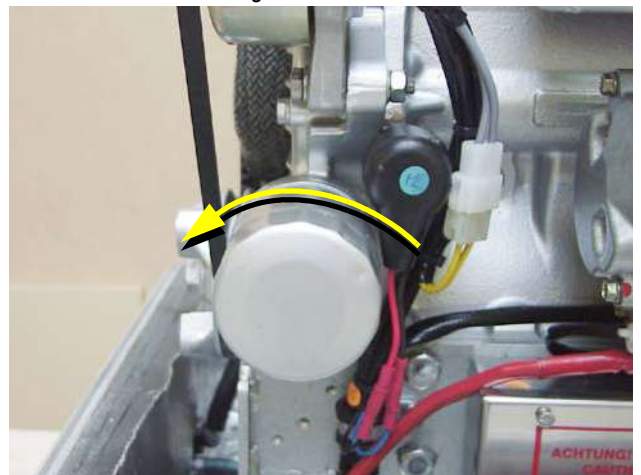
## 5. Remove used oil filter / clean oil screen

Release the oil filter by turning the filter wrench counter-clockwise. The filter might be full of oil. Make sure to not spill anything and avoid skin contact.

Sample picture



Fig. 7.8-3: Oil filter



### Oil screen with generators with EA300 engines

The oil screen should be cleaned every 500 operating hours: to do so follow the instructions in the engine manual.

Use spanner size 17 mm.



*Sample picture*

Fig. 7.8-4: Oil screen



#### 6. Preparing a new filter

Clean the engines' filter holder brush a thin oil layer on the sealing of the new filter.

Fig. 7.8-5: Oil screen sealing ring



#### 7. Mounting the new filter

Carefully screw in the new filter by hand. It must not be tightened too much. Screw in the oil drain screw again and tighten it with the wrench. Use a new sealing for the oil drain screw.

#### 8. Fill in oil. (oil fill capacity: see attachment)

Fill the engine oil into the engine via feed hopper. Check oil-level after every 2 litres with the oil dipstick.

#### 9. Check proper filling level. See section 7.7, "Checking oil-level," on page 98.

When the proper filling level is reached, screw in the oil cap again. Run the engine for 10 minutes and then turn it off. Check the oil-level once more after several minutes with the oil dipstick. If it is too low, refill some oil.

#### 10. Clean up

Wipe off all oil splashes from the generator and make sure that the drain screw has no leak.

### 7.8.1 After the oil change

- Put the oil dipstick back into the check rail.
- Close the oil filling cap.
- Remove potential oil stains and splashes from the generator and surroundings.
- Close the generator casing.
- Remove lock against accidental generator start.
- Duly dispose of used oil and filter.

Used oil is very toxic and must not be disposed with domestic waste. It is prohibited to dispose used oil with waste water! Make sure that used oil is disposed properly (e.g.: where oil is bought or at collection stations).

## 7.9 Verifying the starter battery and (if necessary) the battery bank

Check the condition of the battery. Proceed here as prescribed by the battery manufacturer.

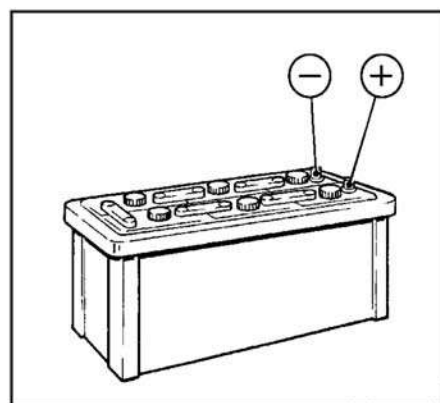
If from the battery manufacturer not otherwise mentioned.

### 7.9.1 Battery

#### 7.9.1.1 Check battery and cable connections

- Keep battery clean and dry.
- Remove dirty clamps.
- Clean terminal posts (+ and -) and clamps of the battery, and grease with acid-free and acid-resistant grease.
- When reassembling, ensure that clamps make good contact. Tighten clamp bolts hand-tight.

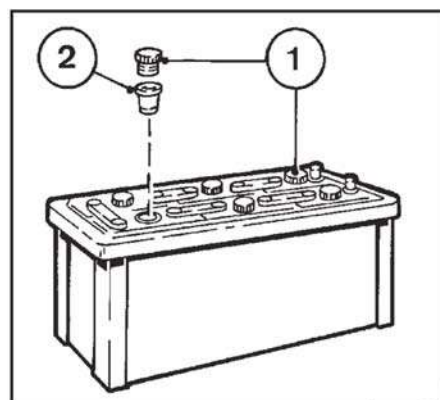
Fig. 7.9.1.1-1: Battery



#### 7.9.1.2 Check electrolyte level

- Remove sealing caps 1.
- If testers 2 are present:
- Electrolyte level should reach the base of these.
- Without testers:
  - The electrolyte level should be 10-15 mm above the top of the plates.
- If necessary, top up with distilled water.
- Screw sealing caps back in.

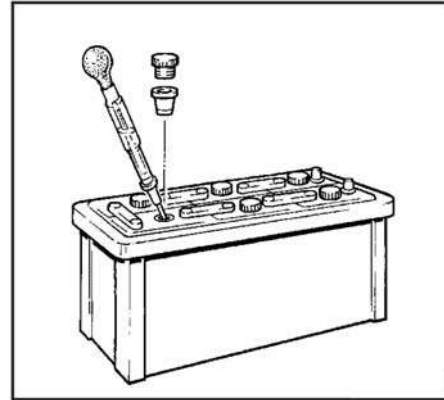
Fig. 7.9.1.2-1: Battery



#### 7.9.1.3 Check electrolyte density

- Measure the electrolyte density of individual cells with a commercial hydrometer. The hydrometer reading (see table on following page) indicates the battery's state of charge. During measurement, the temperature of the electrolyte should preferably be 20 °C.

Fig. 7.9.1.3-1: Battery



Electrolyte density		
in [kg/ l]		Charge status
Normal	Tropical	
1.28	1.23	well charged
1.20	1.12	semi-charged, re-charge
1.12	1.08	discharged, immediately charge

The gases emitted by the battery are explosive! Keep sparks and naked flames away from the battery!

Do not allow battery acid to come into contact with skin or clothing!

Wear protective goggles!

Do not rest tools on the battery!

Attention



## 7.10 Grease lubricated generator backend bearing

A bearing change should only be executed by a trained expert.

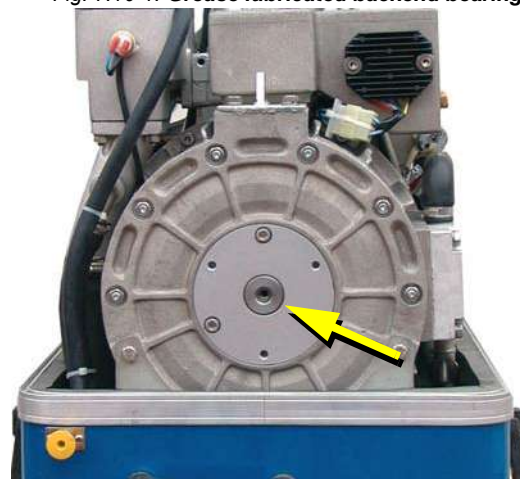
The bearing is, depending on the generator model, equipped with a black cooling disc.

The grease lubricated generator bearing is maintenance free over its durability, but should be exchanged every 1500 operating hours.

**Grease lubricated backend bearing without cooling disc.**

Fig. 7.10-1: Grease lubricated backend bearing

Sample Picture

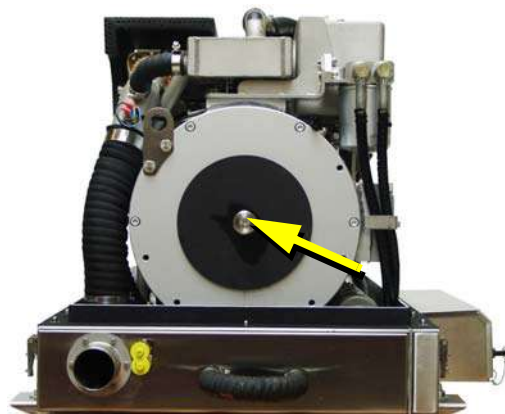




**Grease lubricated backend bearing with cooling disc.**

Fig. 7.10-2: Grease lubricated backend bearing

Sample Picture



**7.10.1 Exchange of grease lubricated bearing**

Only special trained persons are allowed to do this maintenance!

**STOP!**



**DANGER FOR LIFE!** - Inappropriate handling can lead to health damages and death.

**Warning!: Automatic start**

The battery bank must always be disconnected (first negative pole, then positive pole), while working at the generator or at the generators' electrical system, so that the generator can not be started unintentionally.

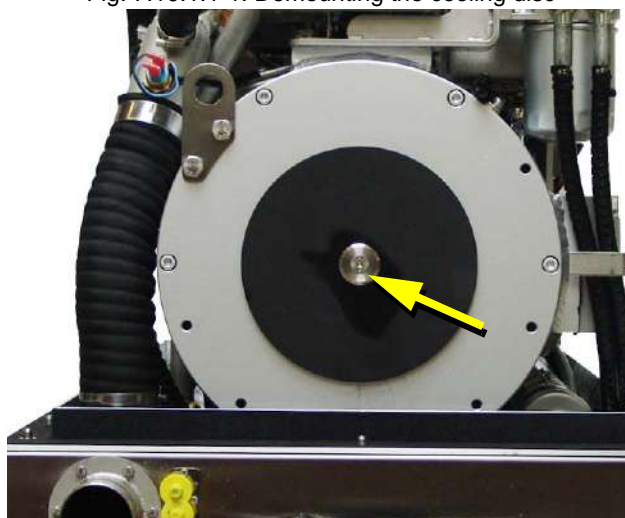


**7.10.1.1 Demounting the cooling disc (if existent)**

To demount the cooling disc, detach the cooling discs' holding nut and take off the disc.

Fig. 7.10.1.1-1: Demounting the cooling disc

Sample Picture



**7.10.1.2 Demounting the backend bearing**

Degrease the spot with a fat solvent as shown, apply markings with a waterproof pen.

*Sample Picture*

Fig. 7.10.1.2-1: Marking the bearing cover.



### Demounting the bearing cover

- Unscrew fixing bolts (Tools Allen key SW6).
- Fasten fixing bolts by hand into the holes for disengaging as far as possible.
- Then alternately fasten these three bolts equally.

**Thus the bearing cover will be pushed out of the generator cap equally.**

- Remove ball bearing with a usual extractor from the shaft.

01. Bearing cover

02. Fixing screw

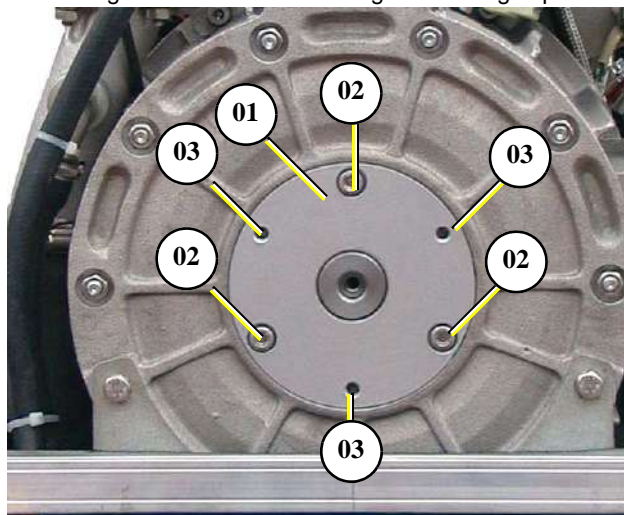
03. Holes for disengaging

*Sample picture*

**If there is no suitable extractor available, a suitable extractor can be purchased from Fischer Panda.**

**Check the O-ring seal which is mounted in the bearing cover and replaced if damaged.**

Fig. 7.10.1.2-2: Demounting the bearing cap



**Note:**





### 7.10.1.3 Installing the new backend bearing

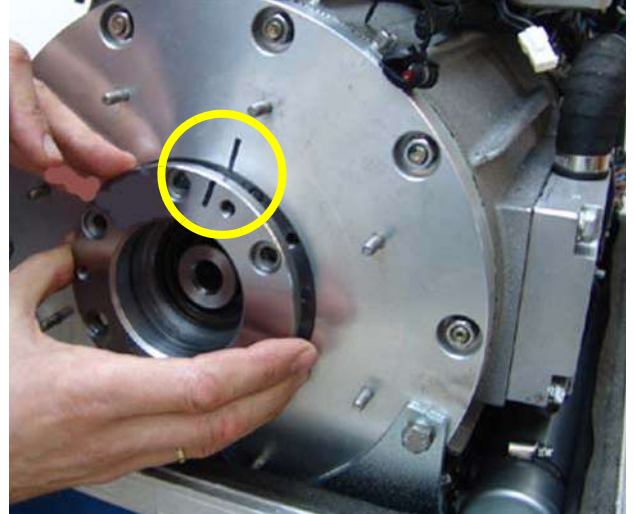
Mount bearing case in the generator cap.

Place bearing case loosely into the generator cap, assure with one hand against falling out.

Thereby pay attention that the case is mounted in the same position as before - the previously added markings have to match again!

*Sample Picture*

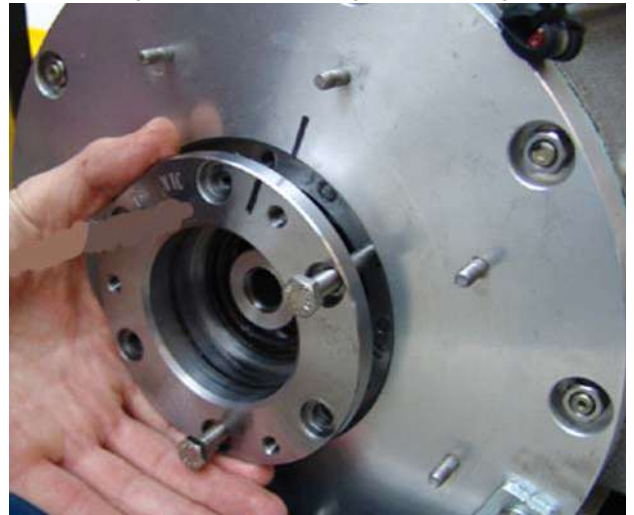
Fig. 7.10.1.3-1: 1Mount bearing cover



With the other hand, loosely screw in the ejector screws as guide line.

*Sample Picture*

Fig. 7.10.1.3-2: Bearing case mounting



Carefully press the bearing case with a soft-head hammer (or a hammer plus mandrel) in its hub.

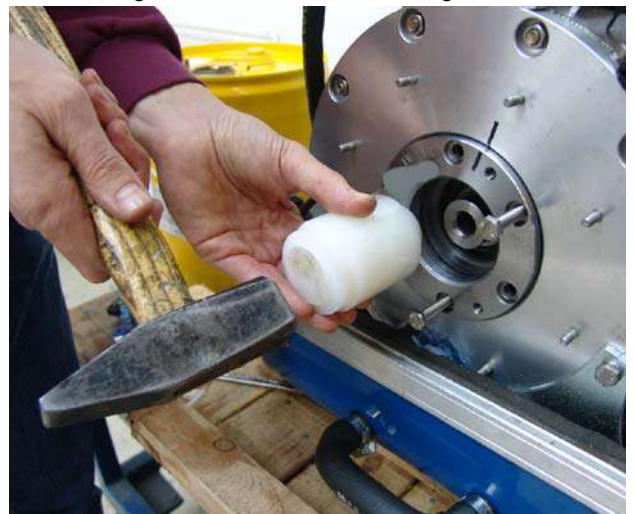
Thereby relocated mandrel rotatory after each hit to avoid canting.

Otherwise there is a risk that the case is slightly canted because of the material which is brought up by the ejector screws.

A canted bearing case causes a canted ball bearing, which will wear out quite fast!

*Sample Picture*

Fig. 7.10.1.3-3: Press fit bearing case



Tighten fixing bolts M8 with 22 to 25 Nm (Allen key SW6).

Now carefully press the bearing case with a soft-head hammer (or a hammer plus mandrel) in its hub.

Thereby relocate mandrel rotatory after each hit to avoid canting.

Otherwise there is a risk that the case is slightly canted because of the material which is brought up by the ejector screws.

**A canted bearing case causes a canted ball bearing, which will wear out quite fast!**

*Sample Picture*

**Screw in thread rod into the thread hole of the generator shaft as far as possible.**

*Sample Picture*

**Slide on ball bearing, pressure ladle, grommet up to the shaft, screw on long hexagon nut. Grease/Oil thread rod.**

**Guide ball bearing with one hand to avoid canting on the shaft.**

*Sample Picture*

Fig. 7.10.1.3-4: 'Attach bearing case

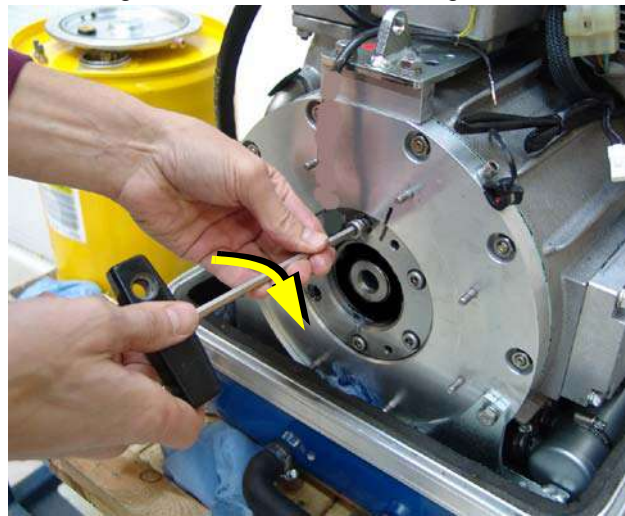


Fig. 7.10.1.3-5: Screw in thread rod

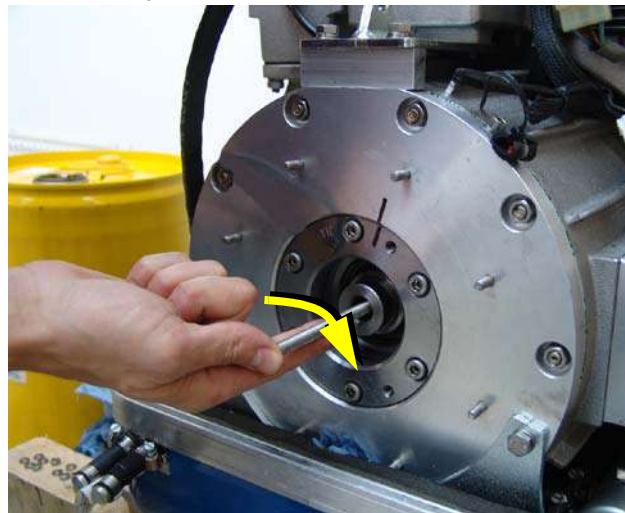


Fig. 7.10.1.3-6: Put on ball bearing





With the other hand, put a screw wrench on the long nut, fasten slowly.

Thus the ball bearing is pressed onto the shaft.

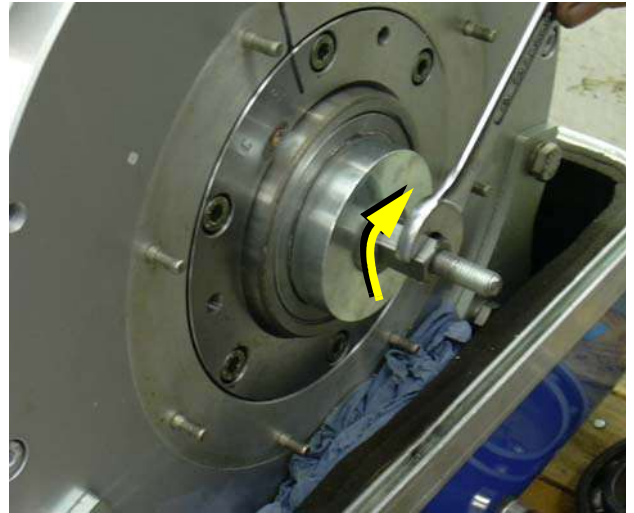
If necessary hold driving shaft with suitable wrench, to prevent diesel engine from rotation simultaneously.

Press on ball bearing as far as possible.

(Tool Wrench SW13 and SW 22)

*Sample Picture*

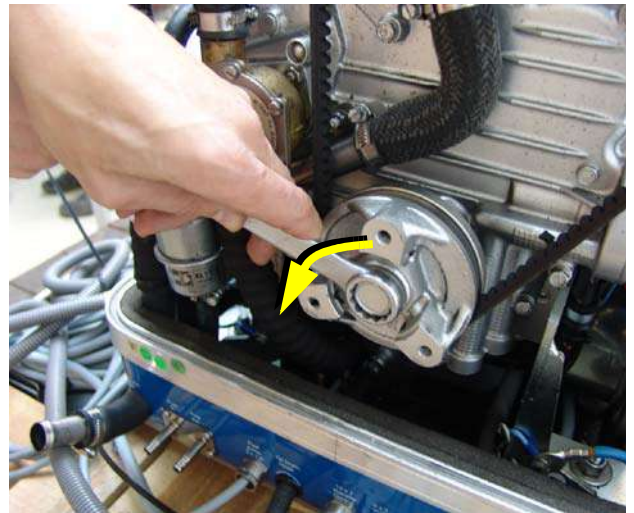
Fig. 7.10.1.3-7: Press in ball bearing



**Hold up the driving shaft.**

*Sample Picture*

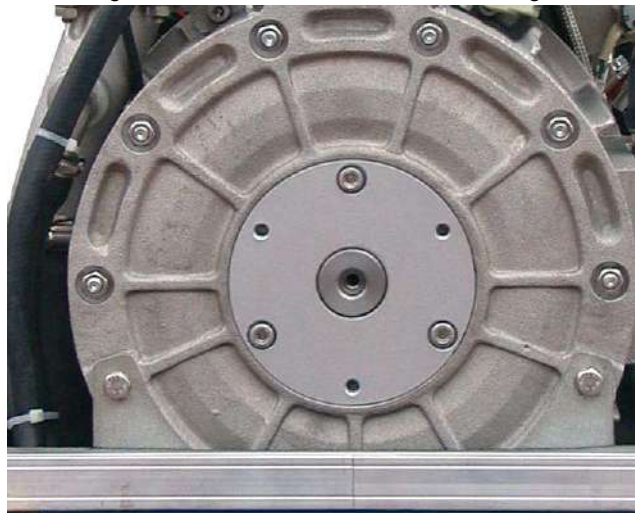
Fig. 7.10.1.3-8: Hold up the driving shaft



- Remove tools.
- Remove markings.
- Mount cooling disc (if existent).
- Mount presilencer and circuit points.
- Refill cooling water and vent cooling water circuit (see generator manual).
- Remove starting lock.
- Reconnect starter battery.
- Run generator 3 to 5 minutes.
- Mount casing.

*Sample Picture*

Fig. 7.10.1.3-9: Remove tools and markings

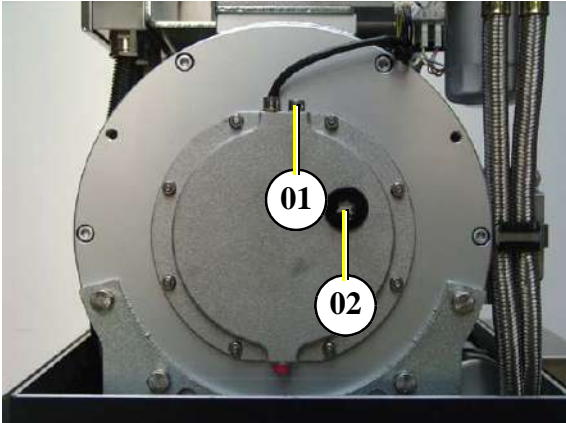


## 7.11 Checking the oil level of the generator end bearing at Fischer Panda generators

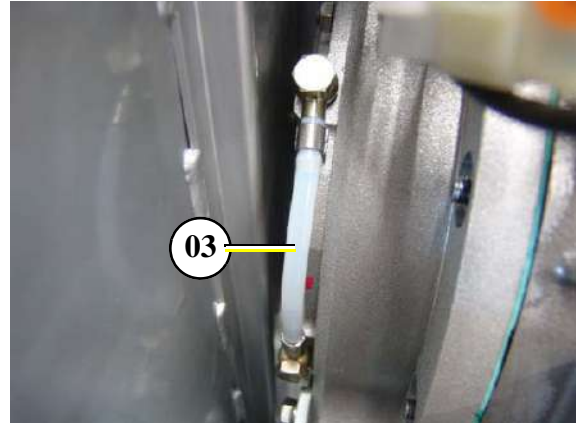
---

The oil level check is a visual check. Older generators are equipped with an sight glass, newer ones with an sight hose.

Fig. 7.11-1: Oil check



Older version



Newer version

- 01. Screw plug
- 02. Sight glass

- 03. Sight hose

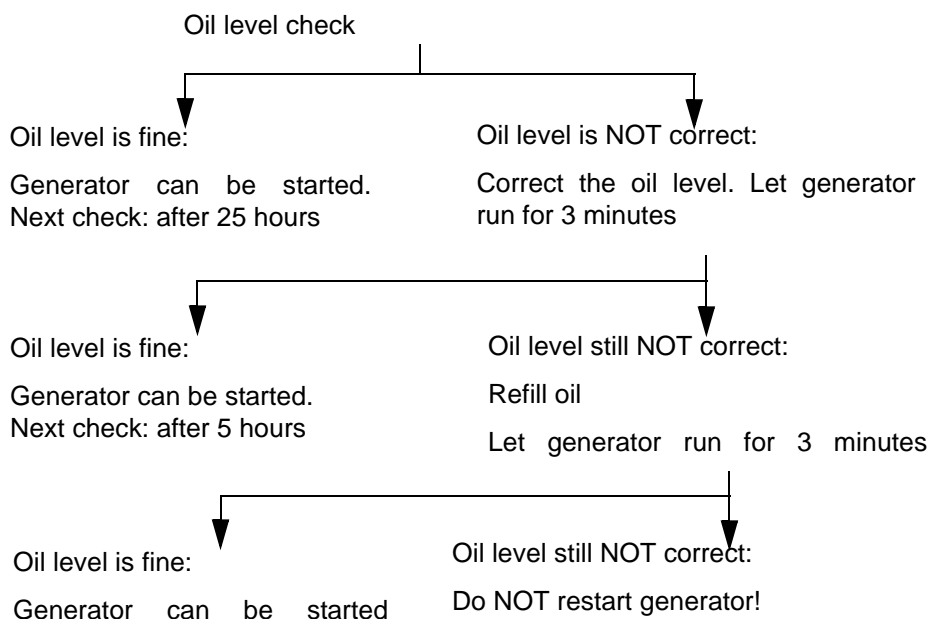
If your generator does not feature these control modules or if these are not accessible, please refer to your Fischer Panda distribution partner or to Fischer Panda directly. The correct oil level is at the middle of the sight glass/ sight hose.

Oil level check is only to be executed when the generator is switched off!

### 7.11.1 Oil level check

---

Fig. 7.11-1: Oil level check





### 7.11.2 Refilling oil

---

1. Remove the Allen screw M8 at the right side of the sensor cable.
2. Refill some oil by means of a small hopper or a syringe.
3. Now tighten the screw again and fasten it with 20 Nm.

### 7.11.3 Refiller-Set

---

An appropriate refiller set can be purchased at Fischer Panda.

The refiller set contains:

Oil: Omala S4 GX 220.

Syringe plus hose

### 7.11.4 Screw plug

---

#### ATTENTION:

The screw plug has a ventilation hole!

Do NOT replace it by a normal screw - this will cause oil loss!

Fig. 7.11.4-1: Screw plug



## 7.12 Replacement of the oil-cooled backend bearing

---

---

A bearing replacement should only be executed by a trained professional.

### 7.12.1 Exchange oil-cooled bearing

---

**DANGER TO LIFE!** - Inappropriate handling can lead to health damages or death.

The battery bank must always be disconnected (first negative pole, then plus pole), to ensure that the generator can not be started by accident when operations at the generator itself or its electrical system shall be executed.

Warning!: Automatic start



### 7.12.2 Demounting the bearing

---

### Suction or discharging the oil

It is difficult to access the drain screw.

Therefore we recommend to withdraw the oil by suction by means of a gun/syringe plus hose (from tool package). Let the generator warm up 3-5 minutes, so the oil gets thinner.

Unscrew the ventilation screw (Tool: Allen wrench SW6)

**Inserting the hose through the ventilation screws' tap hole.**

**Extract the oil.**

**Demount the oil cap by loosening the nuts M6 (Tool: Socket wrench SW10).**

Fig. 7.12.2-1: 3. Oil suction

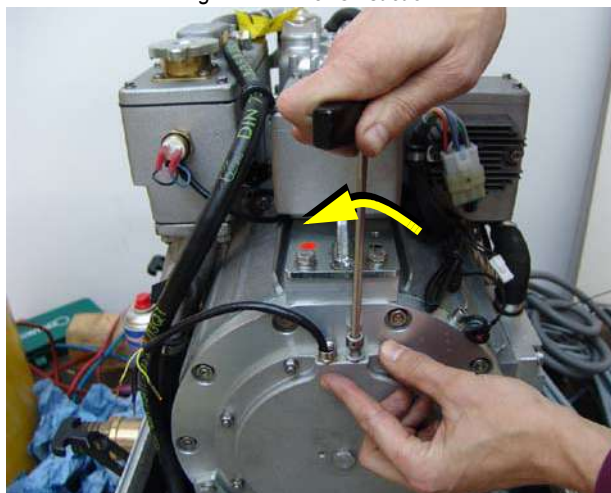


Fig. 7.12.2-2: Oil suction (with syringe)

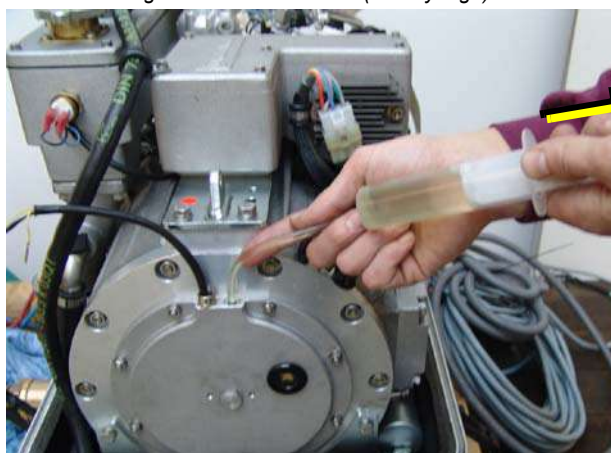
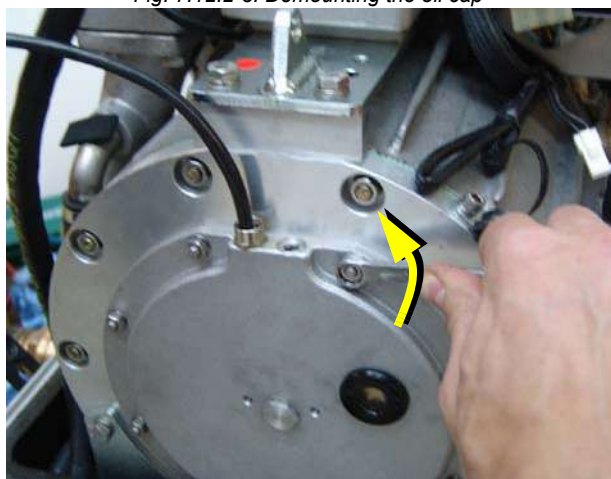


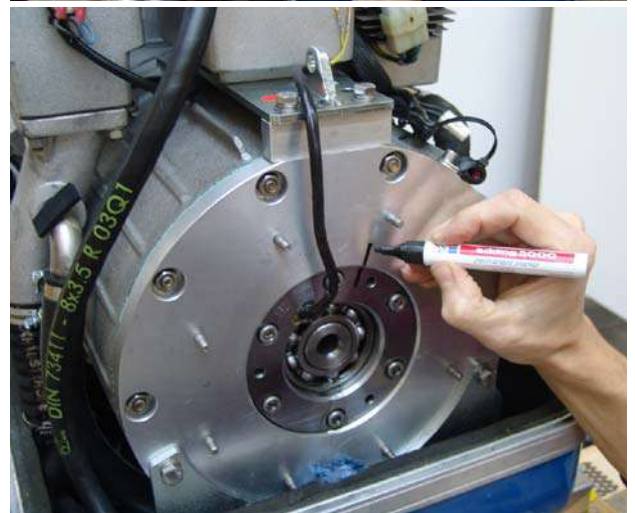
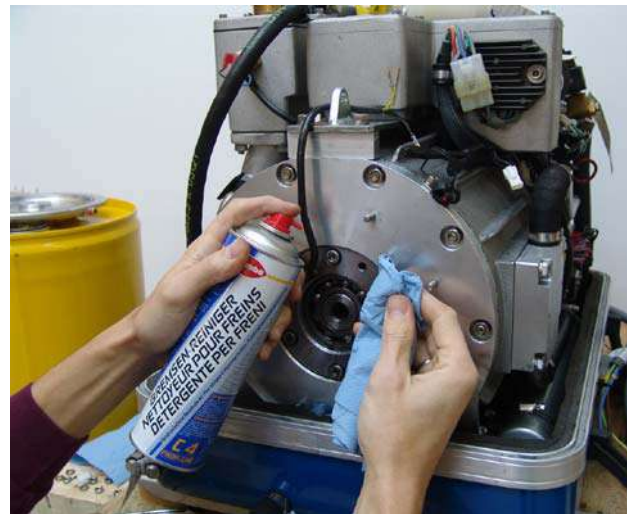
Fig. 7.12.2-3: Demounting the oil cap





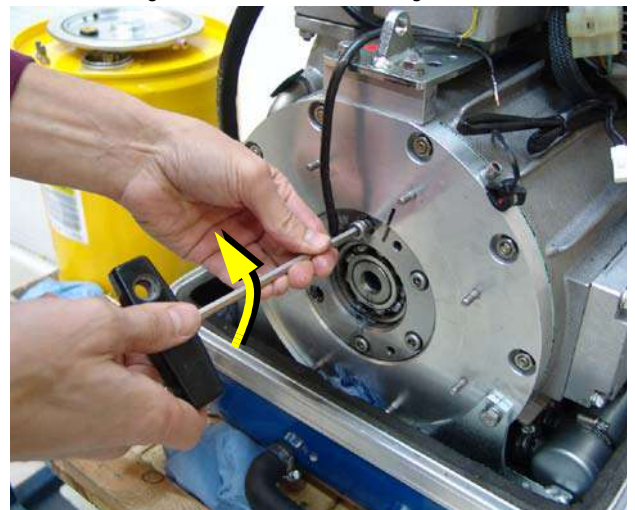
As shown, degrease the spot with a fat solvent and make a mark with a waterproof pen.

Fig. 7.12.2-4: Marking the bearing position



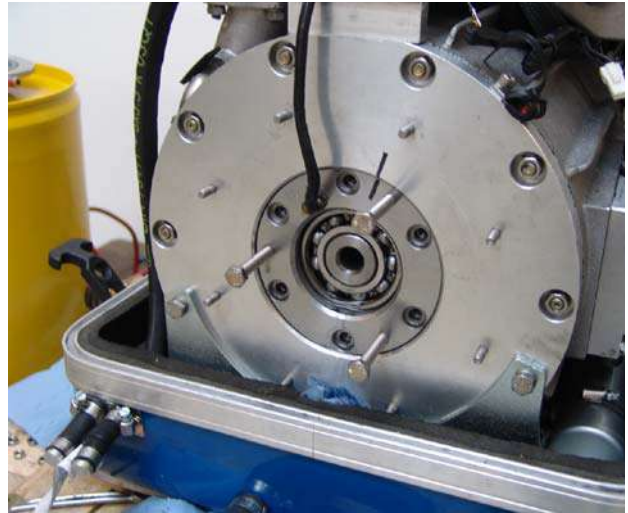
Unscrew the fastening screws (Tool: Allen wrench SW6).

Fig. 7.12.2-5: Loosen fastening screws



As shown, screw in 3 lifting screws M8x50 as far as possible by hand.

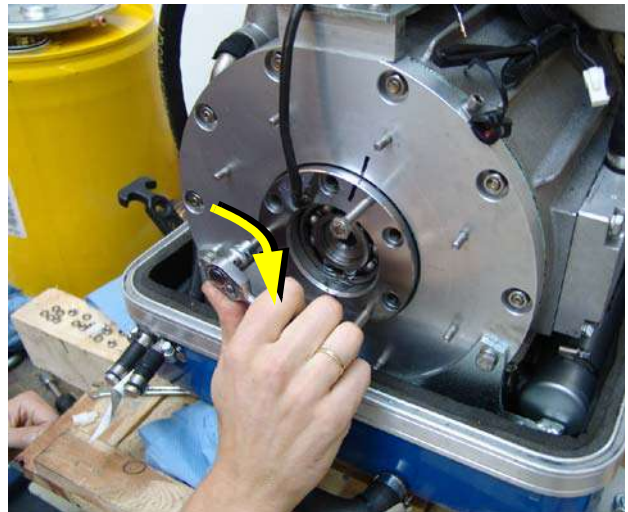
Fig. 7.12.2-6: Insert lifting screws



Then screw in those 3 screws with a screw wrench SW13 equally and in turns.

Fig. 7.12.2-7: Pull off the bearing seat

By doing this, the bearing housing including the ball bearing and the shaft sealing ring are pushed out of the generator cap.



### Knocking out the ball bearing

Fig. 7.12.2-8: Knocking out the ball bearing

Put the bearing housing horizontally on e.g. 2 wood ledges, the ball bearing pointing downwards. Alternatively, the bearing housing can rest on the lifting screws.

Place an appropriate bolt (e.g. extension of a ratch) on the inner bearing ring.

Knock the bearing out of the seat with several careful hammer scales.

Thereby move the bolt after each scale to keep the bearing from canting.





**Dismounted ball bearing**

*Fig. 7.12.2-9: Dismounted ball bearing*



**Dismount the shaft sealing ring:**

We recommend our mandrel.

Put it in the sealing ring with the small end downwards.

Knock the sealing ring out of the seat with careful hammer scales.

*Fig. 7.12.2-10: Dismount the shaft sealing ring*



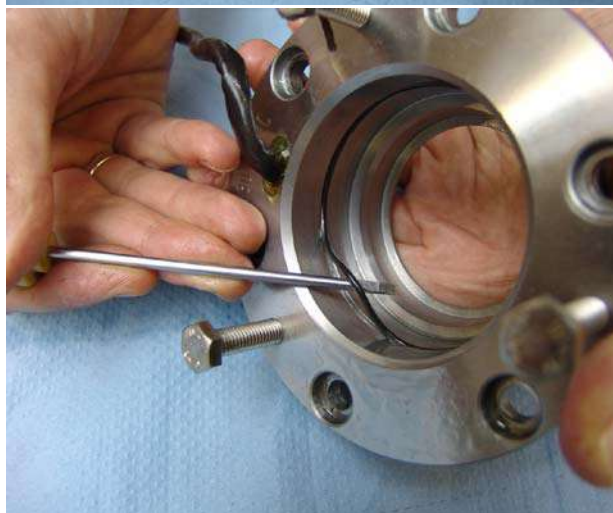
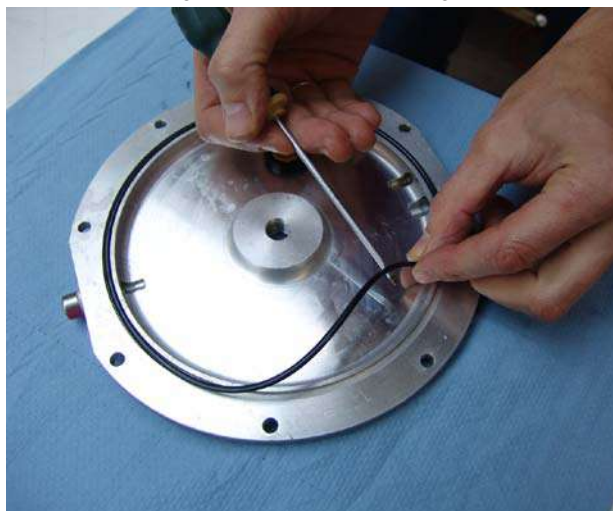
**Dismounted shaft sealing ring**

*Fig. 7.12.2-11: Dismounted shaft sealing ring*



**Remove O-rings from the bearing seat:**

Take both O-rings out of the bearing seat.

*Fig. 7.12.2-12: Remove o-rings***Remove O-ring from the oil cap.***Fig. 7.12.2-13: Remove O-ring*

Clean the bearing seat and the oil cap.

Slightly lubricate the new O-rings and mount them.



**Mounting the NEW shaft sealing ring:**

Lubricate/grease the shaft sealing rings' lip seal.

*Fig. 7.12.2-14: Mounting the shaft sealing ring*



**Clean the mandrel, slightly grease/lubricate the connecting surface and the chamber-bevel.**

*Fig. 7.12.2-15:*



**Push the sealing ring on the mandrel, the open side should point towards the handle. The side marked with „X“ is to be used.**

*Fig. 7.12.2-16:*



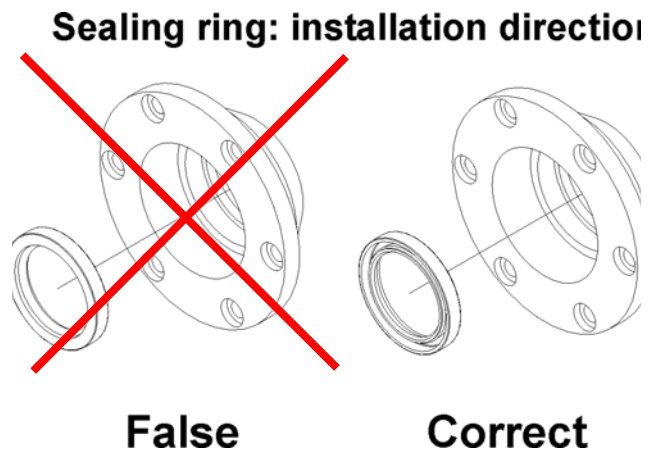
**Mounting of the shaft sealing ring**

*Fig. 7.12.2-17: Fitting the shaft sealing ring*



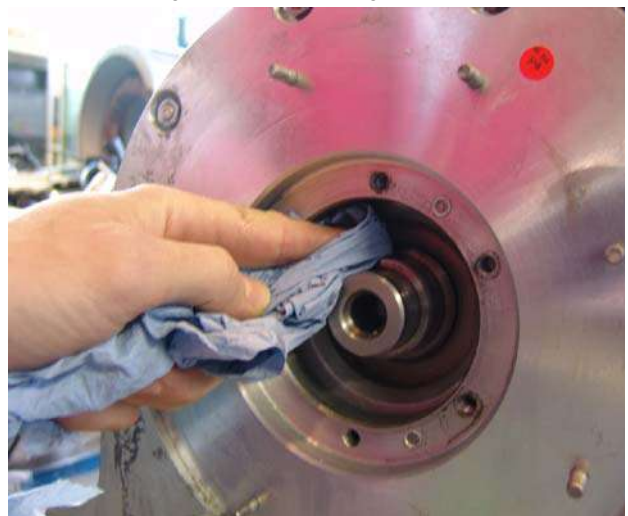
**Correctly mounted sealing ring**

*Fig. 7.12.2-18: shaft sealing ring*



**Clean the shaft**

*Fig. 7.12.2-19: Cleaning the shaft*



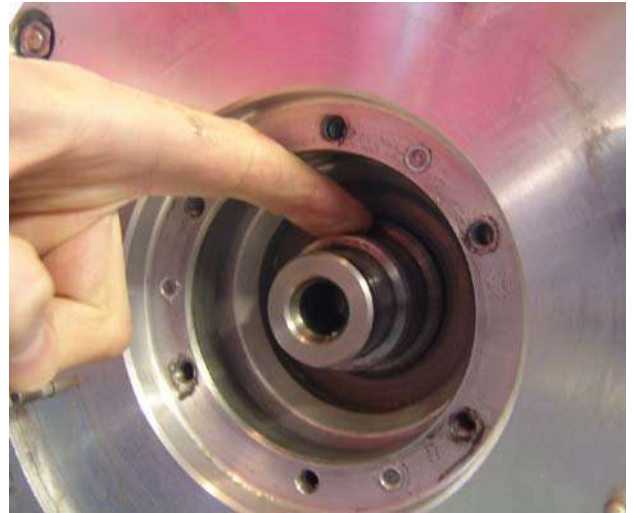


## Check the wheel tread for damages

The wheel tread has to be

- clean
- free of partial damages (drafts, indentations, notches, scratches).

Fig. 7.12.2-20: Checking the wheel tread

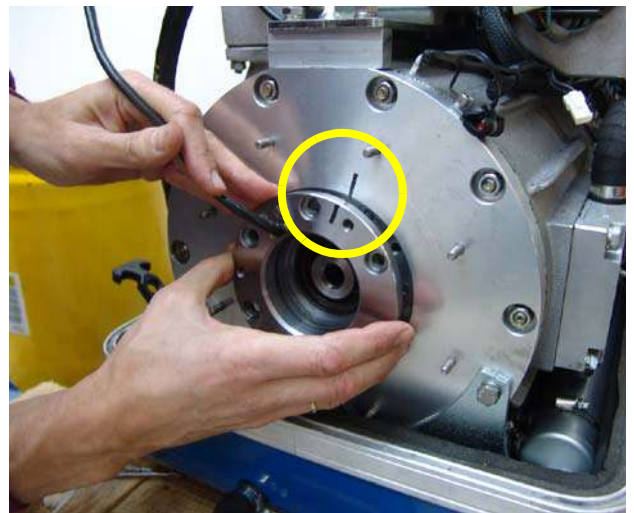


## Mounting the bearing housing inside the generator cap:

Put the bearing housing loosely into the generator cap; securing it against dropping out with one hand.

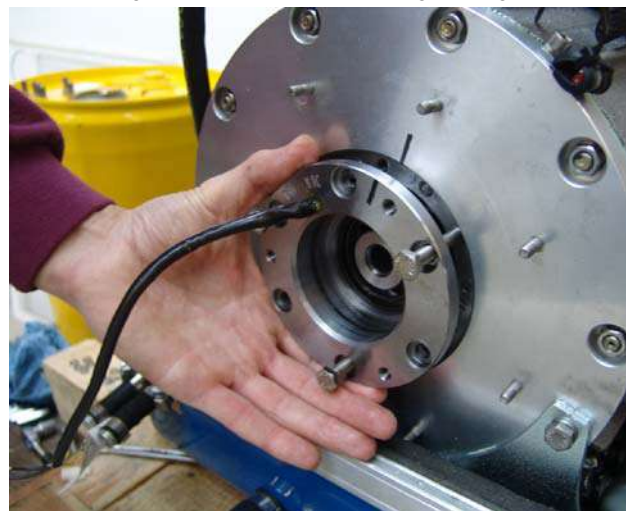
Please make sure the housing is mounted in the same position as it was before - the marking that have been made before dismounting have to fit to each other again!

Fig. 7.12.2-21: Mounting the bearing housing



With the other hand, loosely screw in the lifting screws for guidance.

Fig. 7.12.2-22: Mount the bearing housing



**Now carefully press the bearing housing in its seat with a soft headed hammer (or hammer plus mandrel).**

By doing that, shift the mandrel after each scale in a circle to avoid canting.

Otherwise you might risk that the housing is a little bit canted because of the material that is curled up by the lifting screws.

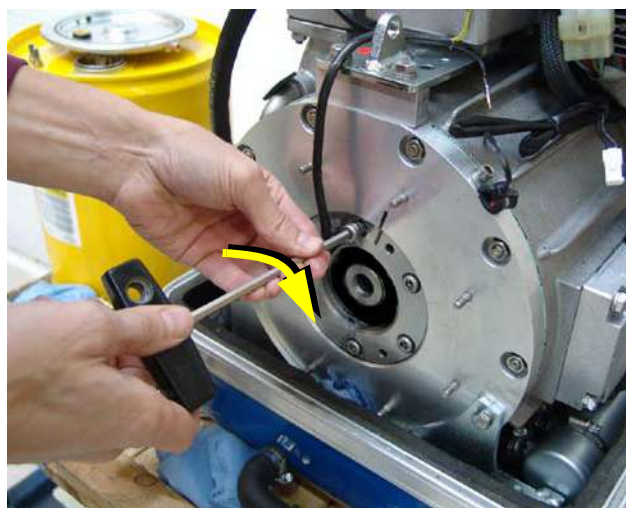
A canted bearing housing causes a canted ball bearing, which will wear out very quickly!

*Fig. 7.12.2-23: Mount the bearing housing*



**Tighten the fastening screws M8 with 22 to 25 Nm (Tool: Allen wrench SW6).**

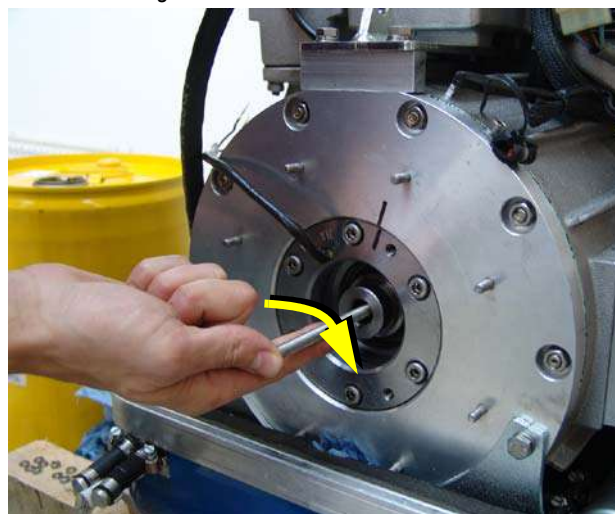
*Fig. 7.12.2-24: Tighten the fastening screws*



#### **Mounting the ball bearing:**

Screw the thread rod into the generator shafts' tap hole as far as possible.

*Fig. 7.12.2-25: Mount the thread rod*





Push the ball bearing, the pressure ladle and the washer up against the shaft, then screw on the hex nuts. Grease/lubricate the thread rod.

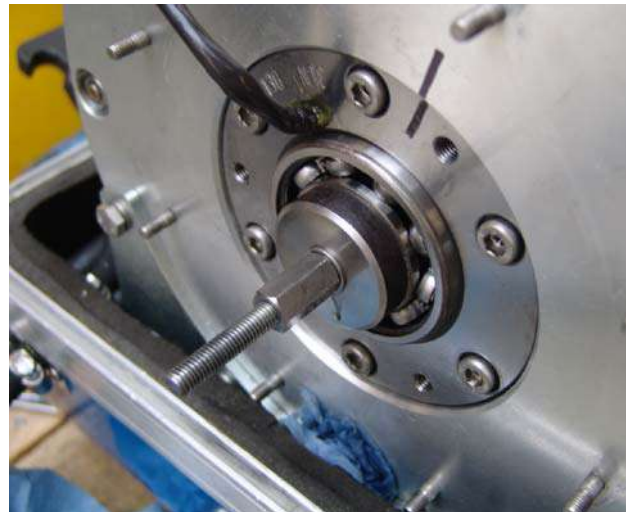
Fig. 7.12.2-26: Mount the ball bearing



Guide the ball bearing with one hand to avoid canting on the shaft.

Fig. 7.12.2-27: Mounting the ball bearing

Put the screw wrench on the long nut with the other hand and tighten it slowly.



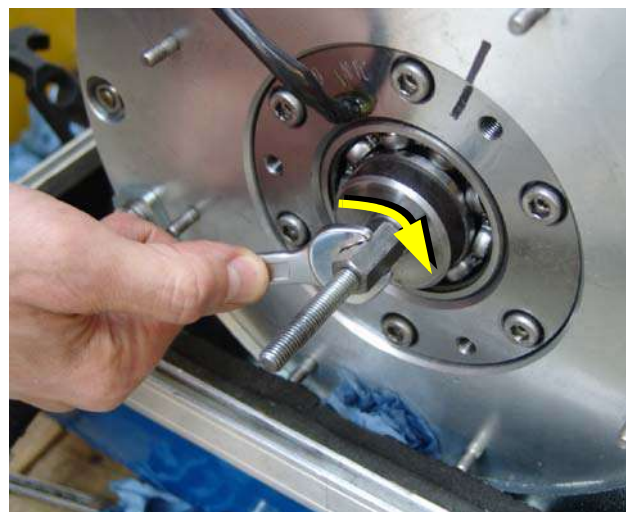
By doing that, the ball bearing is pressed onto the shaft.

Fig. 7.12.2-28: Mount the ball bearing

If necessary, hold the crank shaft with an appropriate wrench to keep the diesel engine from rotating concurrently.

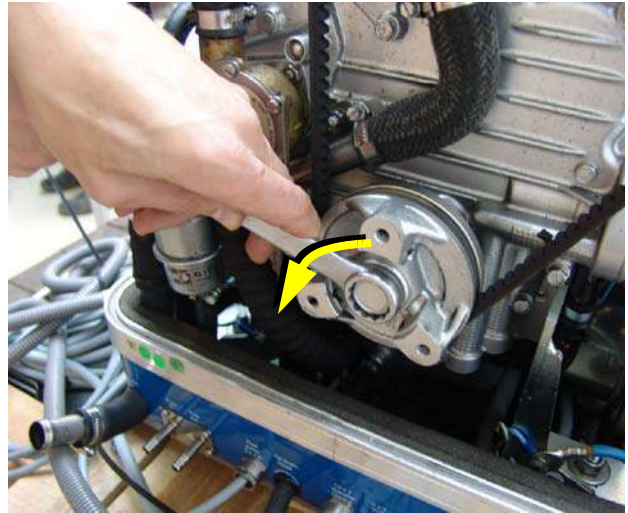
Press the ball bearing on as far as possible.

(Tool: Wrench SW13 and SW22)



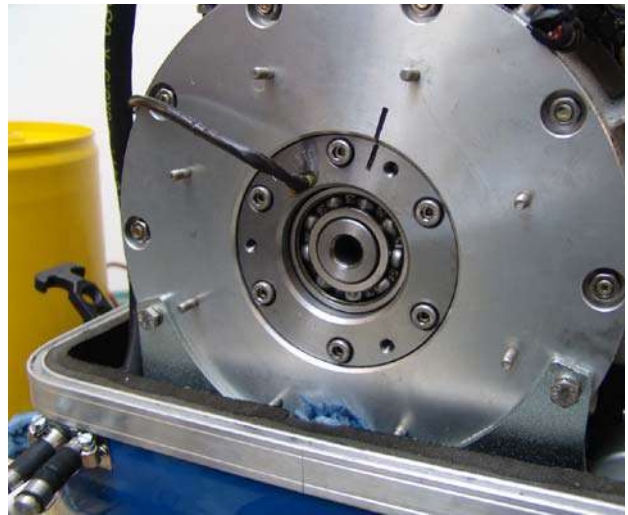
**Hold up the crank shaft**

*Fig. 7.12.2-29:*



**Remove tools**

*Fig. 7.12.2-30: Remove tools*



**Remove markings**

*Fig. 7.12.2-31: Remove markings*



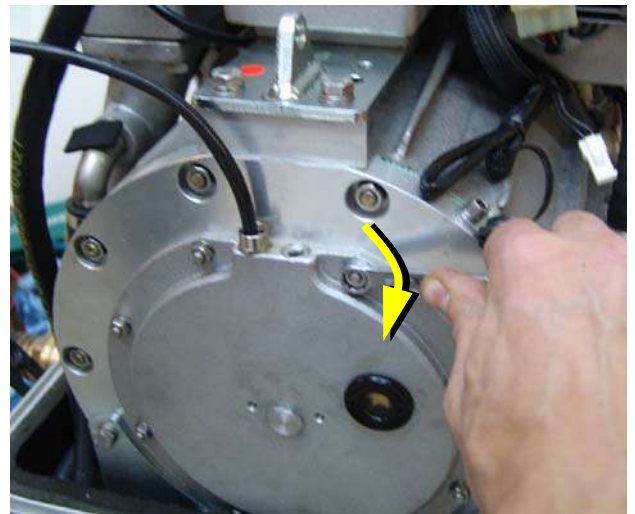


**Tighten oil cap:**

By doing that, pay attention that the O-ring stays in its flute. If necessary, fasten the O-ring with a bit of grease (Tool: Allen wrench SW6).

Nut torque M6: 10 Nm

Fig. 7.12.2-32: Mounting the oil cap



**Filling up the oil:**

Up to the middle of the inspection glass /-hose.

Oil type:

Shell Omala S4 GX 220

Shell Omala HD 320 (Temperature over 35°C)\*

Mobil 1 0W-40 \*\*

Oils that have the following specifications, are classified as adequate:

synthetic gear oil (PAO)

Grades of oil 220 to 320

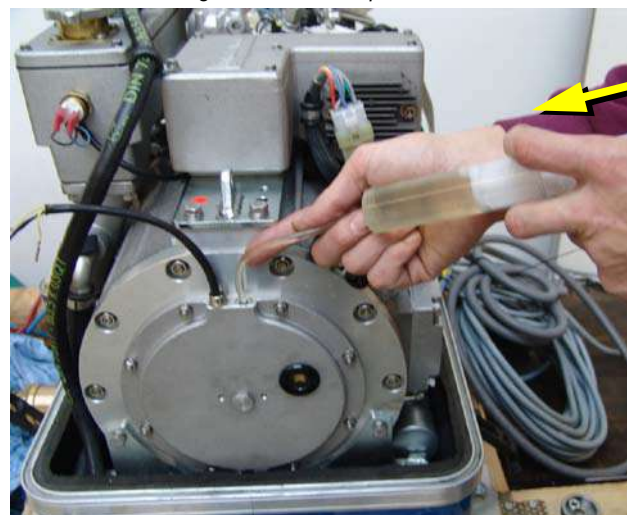
Minimum requirement gear oil: CLP HC

These oils are available at industrial lubricant commerces as well as Fischer Panda.

\* Oil change intervals every 1500 hours

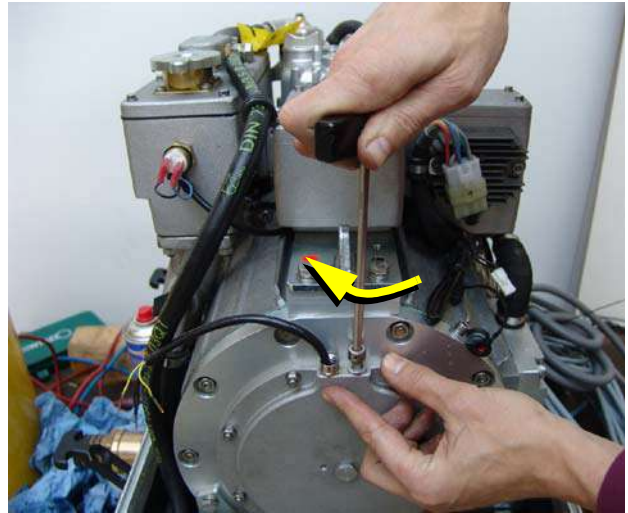
\*\* Oil change intervals every 300 hours

Fig. 7.12.2-33: Fill up the oil



Screw in the ventilation screw and tighten it (Tool: Allen wrench SW6 - 20 Nm).

Fig. 7.12.2-34: Screw in the ventilation screw



Remove the start interlock.

Re-connect the starter battery.

Run the generator for 3-5 minutes.

Check the oil level, if necessary refill/ discharge some oil.

Mount the capsule.

## 7.13 Ventilating the fuel system

Normally, the fuel system is designed to ventilate air itself i.e. as soon as the electric starter motor starts operation the fuel pump starts working and the fuel system will be de-aerated after some time automatically. It is nevertheless essential to ventilate the system as follows prior to the first operation (as all hoses are empty):

**Generators with iControl system do not need a Failure bypass switch. At these generators the fuel pump can be activated by an option of the control panel. See Control panel manual.**

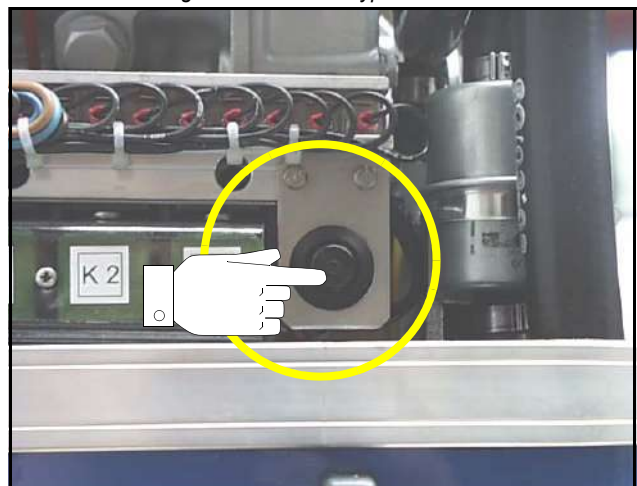
**Attention:**



1. Main power switch „OFF“

2. Press failure bypass switch and keep firmly pressed.  
The electrical fuel pump must be audible. Switching on and off the solenoid valve at the generator will be audible by pressing the failure bypass switch (if capsule removed).

Fig. 7.13-1: Failure bypass switch





3. Pressing the failure bypass switch for approx 3 - 4 minutes will loosen the ventilation screw located at the fuel solenoid valve. The button must continue to be pressed, whilst opening the screw. A large cloth or Kleenex tissue must be laid beneath the connection to prevent escaping fuel running into the capsule. If the fuel runs out without air bubbles, then the ventilation screw can be closed. Only then may the button be released.

Use spanner size 10 mm.

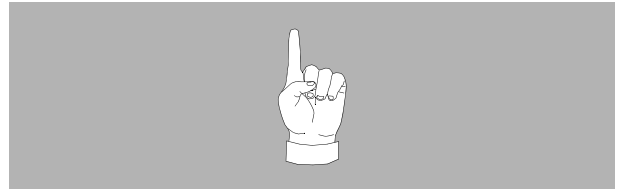


Fig. 7.13-2: Ventilation screw at the fuel solenoid valve



*Not all generator models has a fuel solenoid valve. At generators without fuel solenoid valve, a single ventilation screw is installed.*

**Note!:**



4. Pressing the starter button can now start the machine. The machine should start after a short period.
5. If this does not occur, then a connecting nut fitted to the injection line must be loosened and starting procedure repeated. Retighten the washers after successfully starting. The injection line must be raised by several millimetres.

Use spanner size 17 mm.



Fig. 7.13-3: Injection nozzles



6. Switch main switch „OFF“.

### 7.13.1 Replacement of the fuel filter

Exchanging the filter, depending upon fuel contamination, should take place after 300 operational hours at the very least. The inlet must be clamped, before exchanging the filter.

Remove the hoses from the used filter and fasten them to the new filter. The arrow on the filter housing indicates the direction of the fuel flow. A clogged filter causes a decreased power output of the generator.

Fig. 7.13.1-1: Fuel Filter

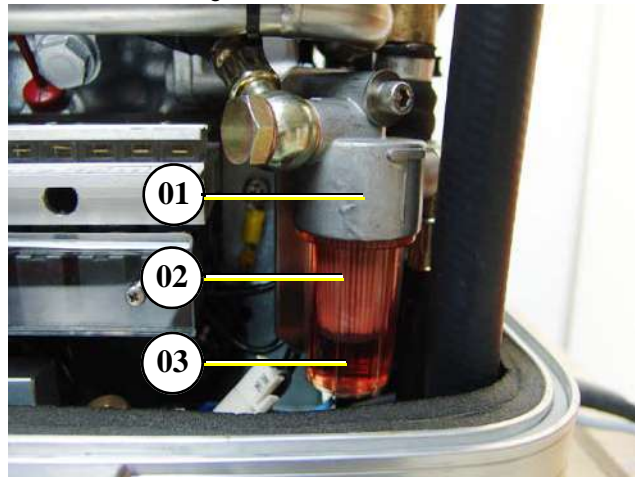


### 7.13.1.1 Optional fuel filter with sight glass

The filter change depends on the fuels' degree of pollution, but should be executed every 300 operating hours at the latest.

- 01. Fuel filter housing
- 02. Fuel filter element
- 03. Sight glass

Fig. 7.13.1.1-1: Fuel filter



1. Unscrew the housing from its mount (left hand rotation).

Fig. 7.13.1.1-2: Fuel filter





2. Unscrew the filter element from the mount (left hand rotation).

Fig. 7.13.1.1-3: Fuel filter



3. Screw the new filter element into the mount.
4. Lubricate the sight glasses o-ring with a heat resistant grease (Specification: Antiseize) and screw the sight glass back into its mount (right hand rotation).

Fig. 7.13.1.1-4: Fuel filter



## 7.14 Checking the water separator in the fuel supply

The pre-filter with water separator has a cock underneath, by which means the water can be drained.

This water sinks to the bottom, due to the difference in the densities of water and fuel. Water is heavier than the diesel

*Sample picture*

Fig. 7.14-1: Pre-filter with water separator



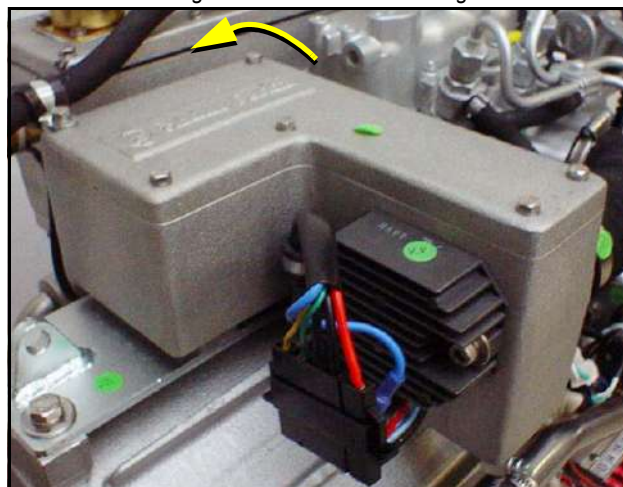
### 7.14.1 Replace the air filter mat

1. Open the air suction housing by loosen the six screws on the housing cover.

Use spanner size 8 mm.

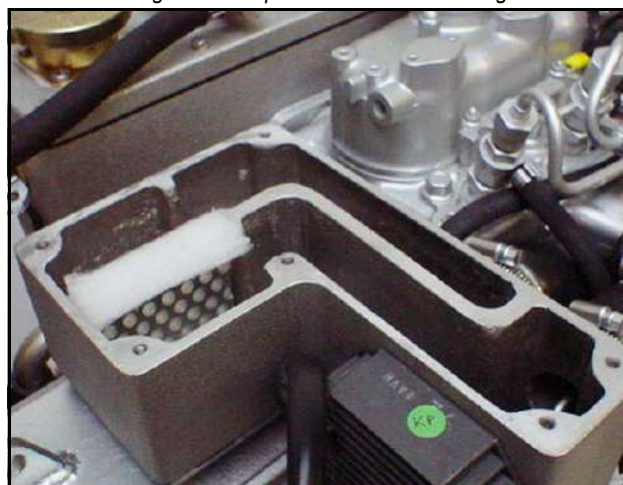


Fig. 7.14-1: Air suction housing



2. Change the air filter mat.
3. Close the suction air housing.

Fig. 7.14-2: Opened air suction housing

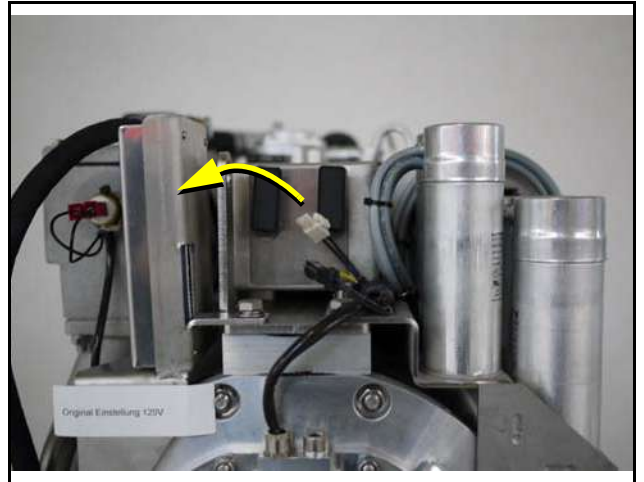




### 7.14.2 Alternative replacement of the air filter mat with pull out holder

1. Air filter housing with pull out holder.

Fig. 7.14.2-1: Air suction housing with pull out holder



2. Tip the two fasteners 90°.

Fig. 7.14.2-2: Air suction housing with pull out holder



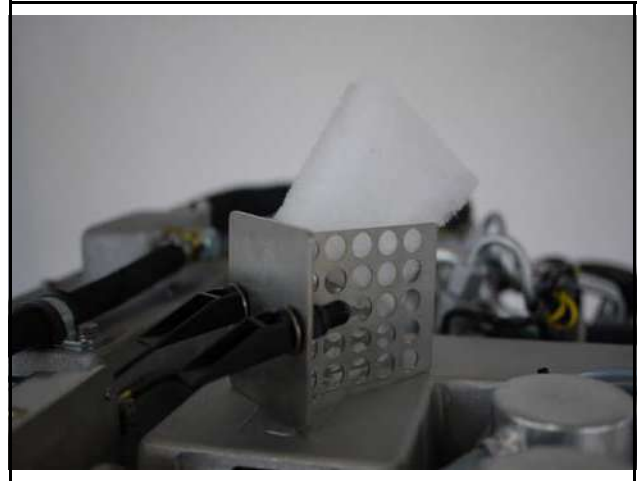
3. Pull the filter mat holder out.

Fig. 7.14.2-3: Air suction housing with pull out holder



4. Replace the air filter mat.
5. Re-assembly in reversed order.

*Fig. 7.14.2-4: Air suction housing with pull out holder*

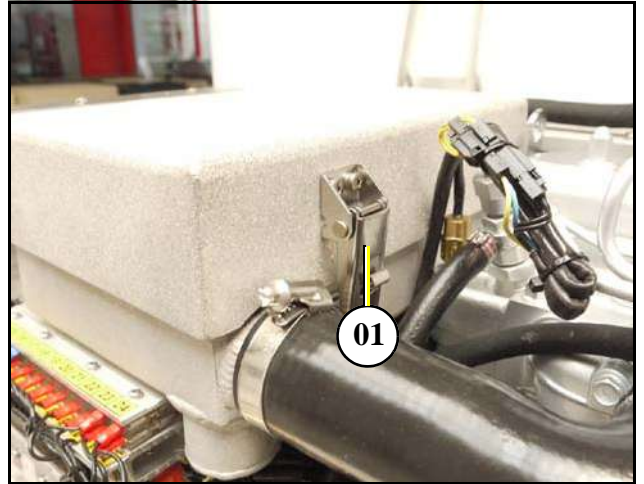


### 7.14.3 Alternative replacement of the air filter at housing with snap fasteners

1. Open the combustion air housing by loosening the closure on the right side of the housing.

01. Closure

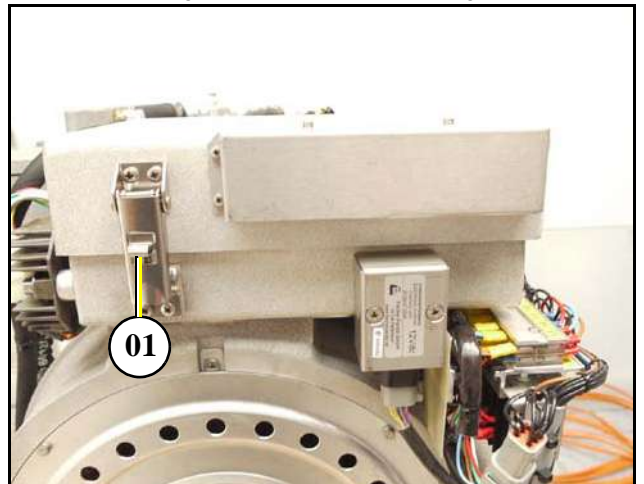
Fig. 7.14.3-1: Air suction housing



2. Open the combustion air housing by loosening the closure on the left side of the housing.

01. Closure

Fig. 7.14.3-2: Air suction housing

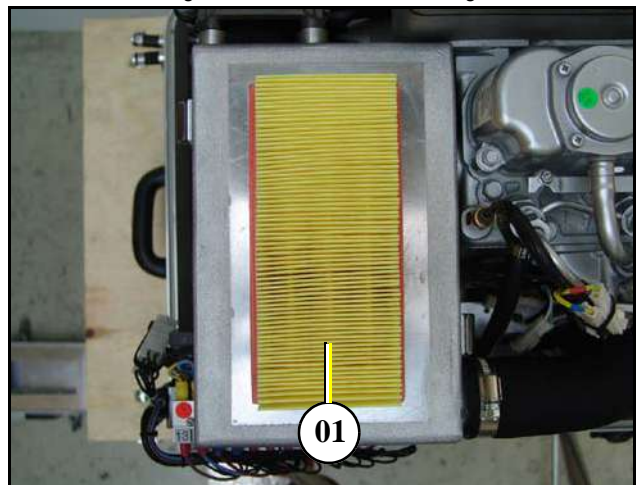


3. Open the air housing by pulling the cover.
4. Lift out the air filter element of the cover of the air filter housing.

01. Air filter

5. Replace cover in reverse procedure.

Fig. 7.14.3-3: Air suction housing



Sample picture

### 7.14.4 Ventilation of the coolant circuit / freshwater

### Special notes for the ventilation of the cooling system

If the cooling water is drained, or if other air has entered the cooling system, it is necessary to ventilate the cooling system.

This ventilating procedure must be repeated several times:

**The generator must be switched off before opening the ventilating points!**

**Pay attention that the external coolant expansion tank is connected with the generator by the intended connection point.**

**Further it should be guaranteed that the expansion tank is attached in sufficient height (600 mm) over the level of the generator exhaust elbow union.**

### Expansion tank

### Attention



Fig. 7.14-1: Expansion tank



Fig. 7.14-2: Ventilating screw

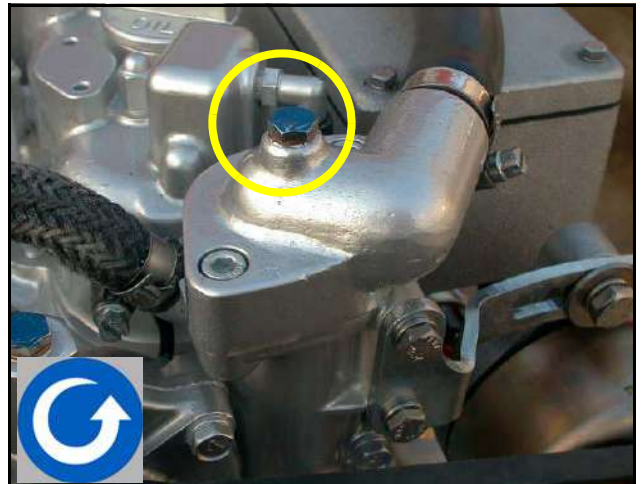
1. Open the ventilating screw above the cooling water pump casing. Not present at all models  
Use spanner size 10 mm.



- Open the ventilating screw on the thermostat casing.  
Use spanner size 10 mm.



Fig. 7.14-3: Ventilating screw on the thermostat housing



- Pour cooling water into the cooling water filling necks.  
(At generators without filler, The cooling water can be filled into the external expansion tank instead)
- If the cooling water level no longer drops (the cooling water level in cold waters must cover the tin in the exhaust elbow), close the filler cover and the cooling water screws and then start the generator.
- Run the generator for approx. 60 Seconds, then switch off
- Refill cooling water via the compensation tank.
- The compensation tank is connected to the generator by two hoses.

Fig. 7.14-4: Cooling water filler cap



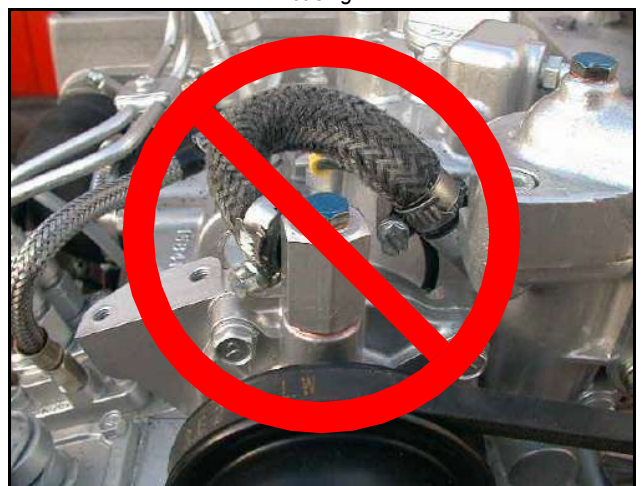
The external compensation tank should be filled to a max 20 % in a cold state. It is very important that a larger expansion area is maintained above the cooling water level.

- Repeat this procedure 1 - 5 times.

If there is no change to the state of the cooling water level, the generator is re-started for 5 minutes. Thereafter the de-aeration must be repeated two to three times.

**The ventilation screw above the cooling water pump casing may not be opened under any circumstances, whilst the generator is running. Air will be sucked through the opening, if this should happen by mistake. Venting the whole system afterwards is necessary and very difficult.**

Fig. 7.14-5: Ventilation screw above the cooling water pump casing



## 7.15 V-belt replacement for the internal cooling water pump

The V-belt wears in a short time due to high ambient temperature within the closed capsule (approx. 85 °C). The air in the generator capsule is not only warm but also very dry. Therefore it is possible, that the „softener“ in the rubber compositors wear after a very short time of operation.

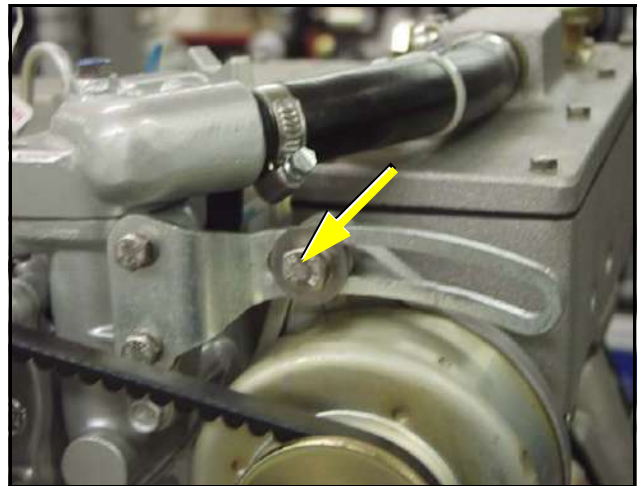
Therefore, the V-belt must be checked in short time distances. It may be possible, that the V-belt must be changed after a few weeks. Therefore the V-belt must be checked every 150 hours. The v-belt must be seen as a wearing part. Therefore it is necessary to have enough spare V-belts on board. We therefore recommend to have the Fischer Panda Service Kit on board.

1. Loose the screw on the upper alternator mounting.



*Sample picture*

*Fig. 7.15-1: Alternator screw*



2. Loose the screw underneath the alternator.



*Sample picture*

*Fig. 7.15-2: Screw underneath the alternator*

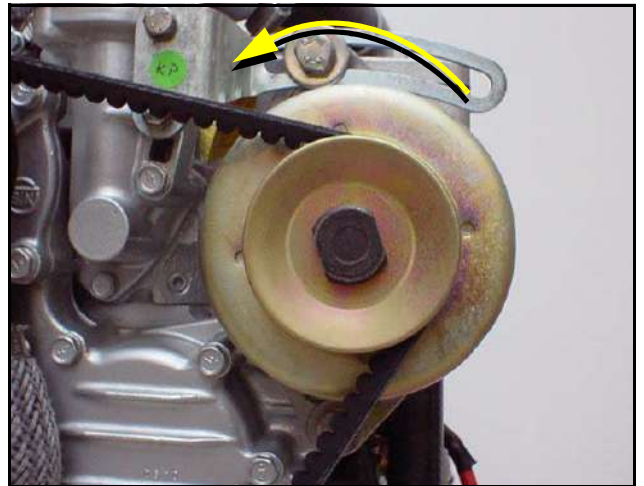




3. The alternator must be pressed in the direction of the thermostat housing.
4. Exchange the V-belt.

*Sample Picture*

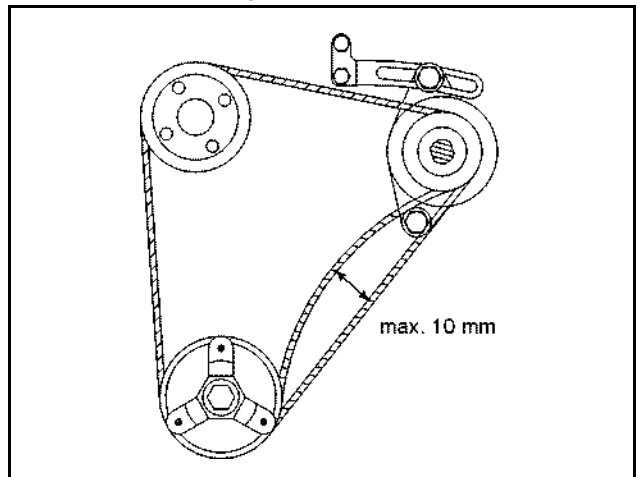
Fig. 7.15.0-3: Alternator



5. Afterwards, the V-belt must be tightened again.
6. The V-belt must be tightened in such a way, that it is possible to press it about approx. 10 mm.
7. Tighten the screws above and underneath the alternator.

*Sample picture*

Fig. 7.15.0-4: V-belt



## **7.16 The raw water circuit**

---

### **7.16.1 Clean raw water filter**

---

The raw water filter should be released regularly from arrears. In each case the water cock must be closed before. It is mostly sufficient to beat the filter punnet.

If water should seep through the cover of the raw water filter, this may be sealed in no case with adhesive or sealant. Rather must be searched for the cause for the leakage. In the simplest case the sealing ring between caps and filter holders must be exchanged.

Fig. 7.16.1-1: Raw water filter



## **7.17 Causes with frequent impeller waste**

The impeller of the cooling water pump must be regarded as wearing part. The life span of the impeller can be extremely different and exclusively depends on the operating conditions. The cooling water pumps of the PANDA generators are laid out in such a way that the number of revolutions of the pump lies low compared with other gensets. This is for the life span of the pump a positive effect. Unfavourable affects the life span of the impeller, if the cooling water sucking in way is relatively long or the supply is handicapped, so that the cooling water sucking in range develops a negative pressure. This can reduce first of all the power of the cooling water pump extremely that the wings of the impeller are exposed to very strong loads. This can shorten the life span extremely. Further the operation of the impeller pump loaded in waters with a high portion of suspended matters. The use of the impeller pump is particularly critical in coral water bodies. Cases are well-known, which a impeller pump had so strongly run after 100 hours already that the lip seal on the wave was ground in. In these cases sharp crystal parts of the coral sand assess in the rubber seal and affect like an abrasive the high-grade steel shank of the impeller pump. If the generator were mounted over the water level it is particularly unfavourable for the impeller pump. After the first start some seconds will pass by, until the impeller can suck in cooling water. This short unlubricated operation time damages the impeller. The increased wear can lead after short time to the loss. (see special notes: "Effects on the impeller pump, if the generator is mounted over the waterline")



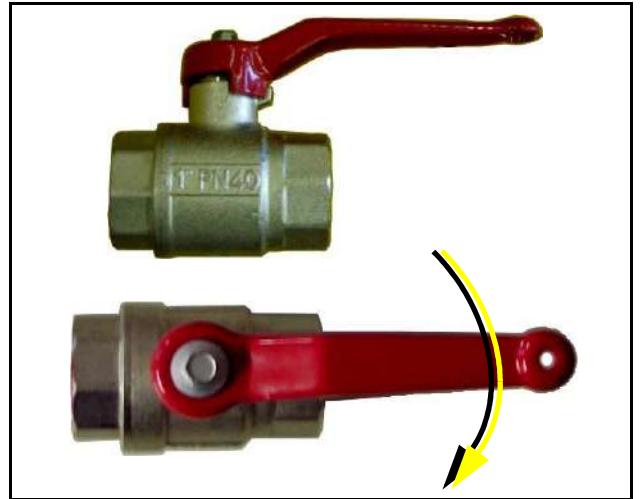


### 7.17.1 Replacement of the impeller

Close the raw water stop cock.

*Representative picture*

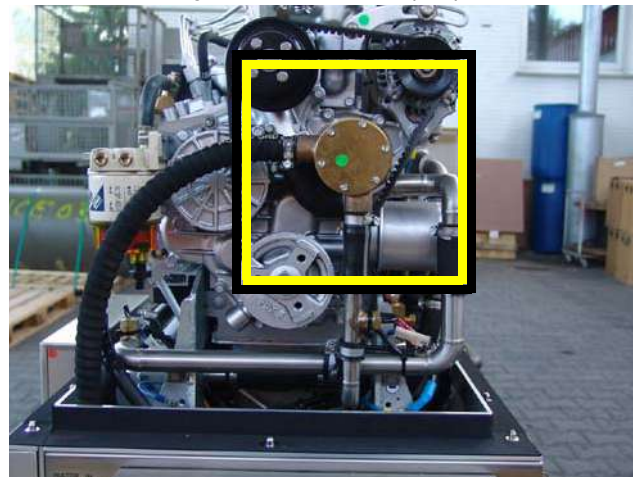
Fig. 7.17.1-1: Raw water cock



Raw water pump on the front side of the genset.

*Representative picture*

Fig. 7.17.1-2: Raw water pump

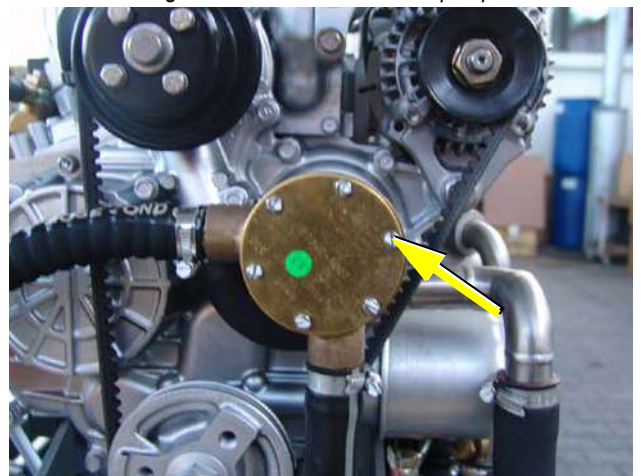


Remove the cover of the raw water pump by loosen the screws from the housing.

Fig. 7.17.1-3: Cover raw water pump



*Representative picture*



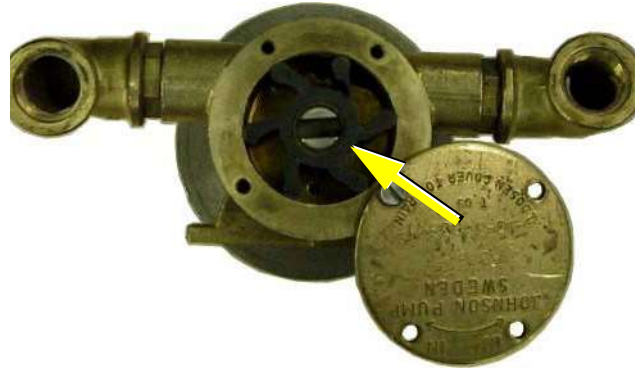
*Fig. 7.17.1-4: Impeller pump*

**Pull to the impeller with a multigrip pliers of the wave.**



Mark the impeller, to make sure that these is used in the correct position at re-installation.

*Representative picture*



**Check to the impeller for damage and replace it if necessary.**

Before the reinsertion into the housing the impeller should have been lubricated with glycerin or with a non-mineral oil based lubricant e.g. silicone spray.

The impeller is attached to the pump wave (if the old impeller is used, pay attention to the before attached marking).

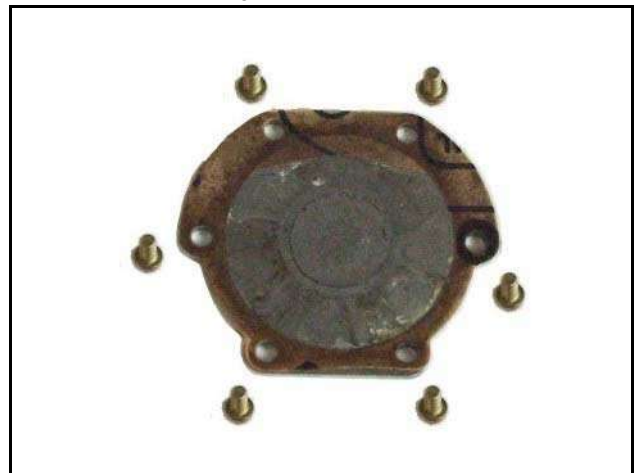
*Representative picture*

*Fig. 7.17.1-5: Impeller*


**Fastening the cover and use a new seal.**



*Representative picture*

*Fig. 7.17.1-6: Gasket*




## 7.18 Replacing the Actuator

The described procedure is representative for Fischer Panda generators. The original location of the item must be taken from the generator description of this manual. All replacements and repairs should be done by a trained person.

**NOTE: Representative procedure**



**Ensure that the generator cannot be started up accidentally. Remove battery main switch.**

**ATTENTION!**



For part numbers, refer to the spare parts catalogue.

1. Open the capsule.
  01. Actuator

Fig. 7.18-1: Actuator

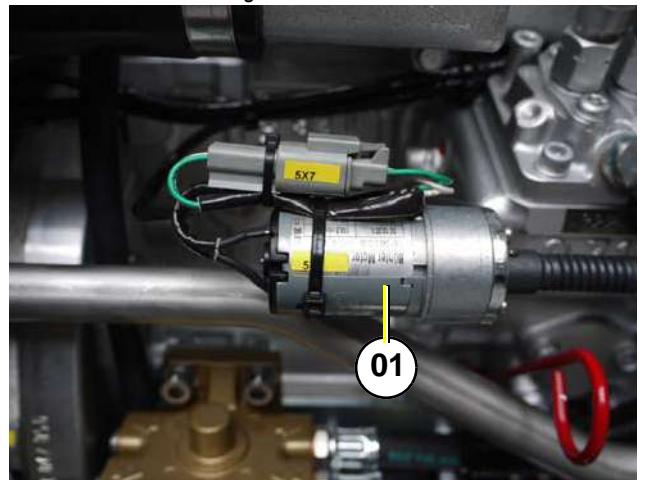
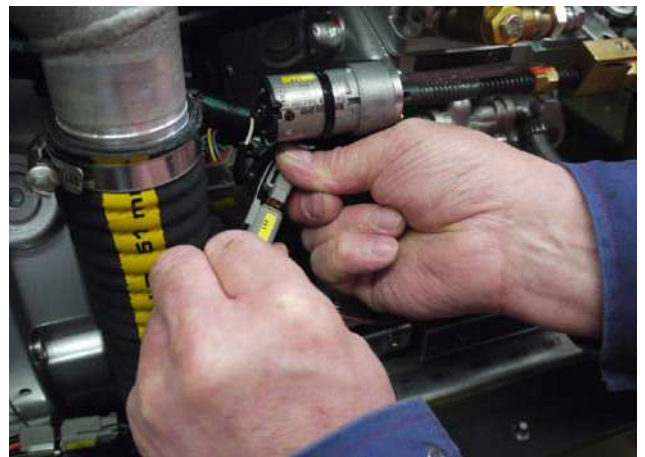


Fig. 7.18-2: Actuator

**Figures similar!**

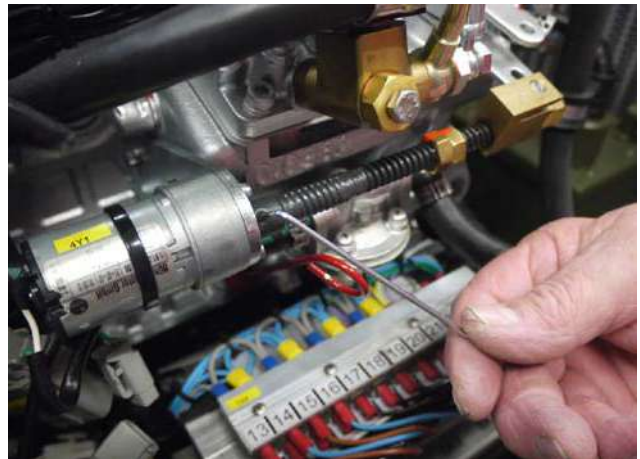
2. Disconnect electric supply line from the actuator.



3. Unscrew the grub screw using a size 2 mm socket wrench.

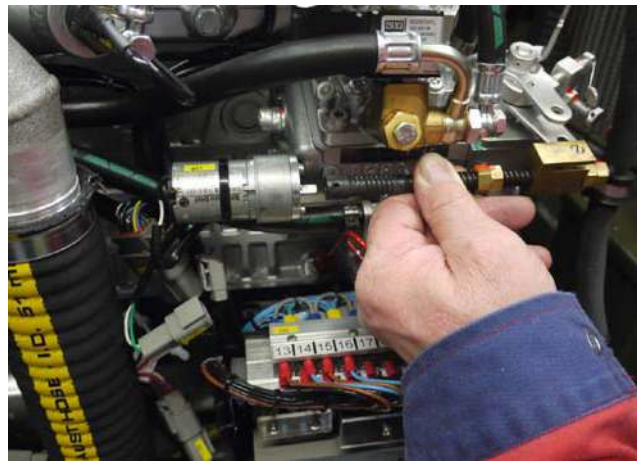


*Fig. 7.18-3: Actuator*



4. Slide spindle to the right.

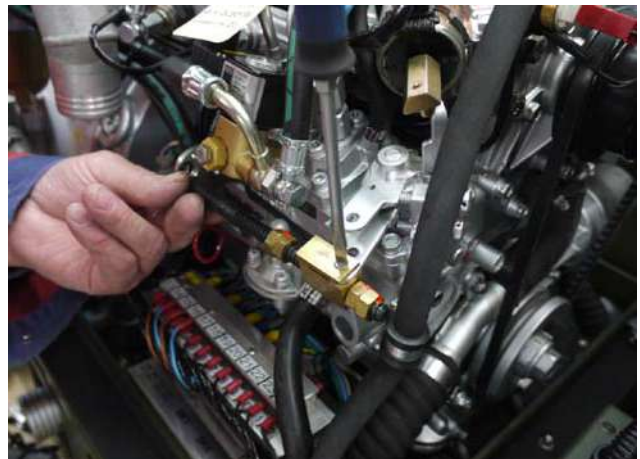
*Fig. 7.18-4: Actuator*



5. Remove screw with a size 0 or 1 screwdriver.

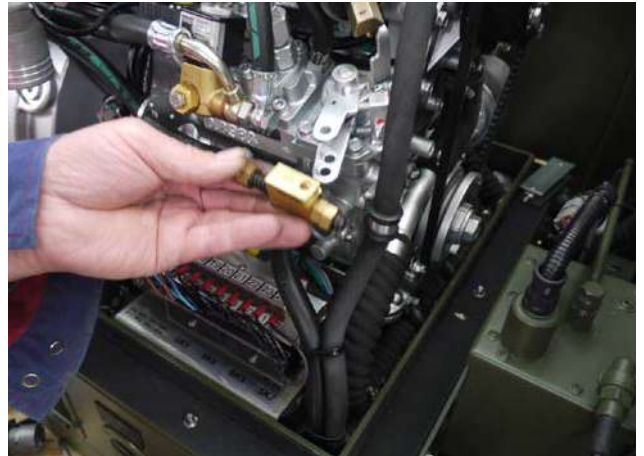


*Fig. 7.18-5: Actuator*



6. Remove the spindle.

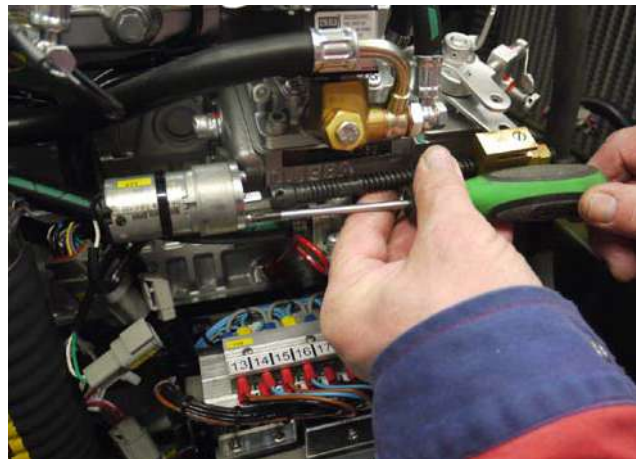
Fig. 7.18-6: Actuator



7. Unscrew three screws on the actuator with a size 0 or 1 phillips screwdriver.



Fig. 7.18-7: Actuator



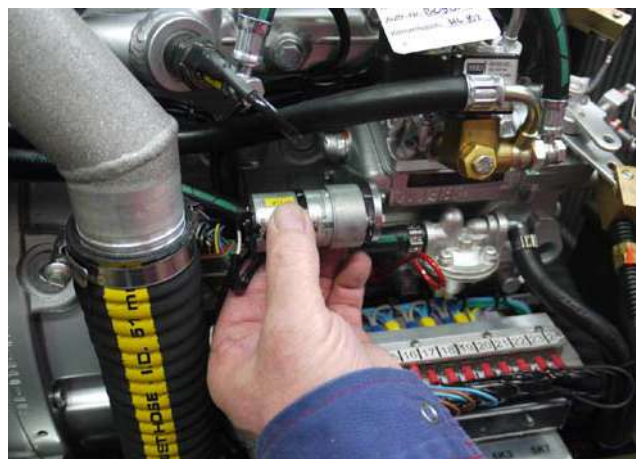
8. Remove the actuator.

9. To reinstall, reverse the order of steps.

10. Pull out electric starter.

11. To reinstall, reverse the order of steps.

Fig. 7.18-8: Actuator



## 7.18.1 Check and discharge the capacitors

**NEVER** check the capacitors whilst the generator motor is running! Charged capacitors can be lethal. Do not contact the capacitors with bare fingers or non-insulated metallic objects! In order to test the capacitors, the terminal lead wires have to be disconnected using pliers or a screwdriver with insulated handle(s). Once the wires have been removed, the capacitors must be discharged by bridging the capacitor terminals with a discharge reactor.

**Attention!:**



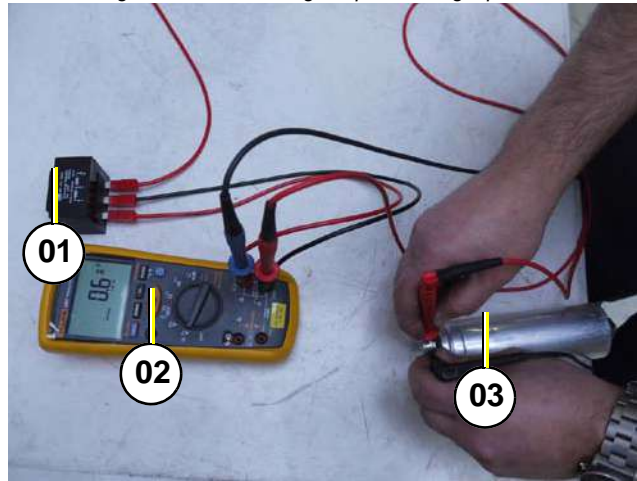
The capacitors can be checked using a multimeter with capacitor measuring.

The capacitors fitted inside the cabinet are discharged over the soldered resistor at every capacitor. The discharge over the discharge reactor (see special tools) is security because the capacitor voltage is lethal.

**Discharge the capacitor - single phase**

- 01. Discharge reactor (5-10kOhm)
- 02. Multimeter
- 03. Capacitor

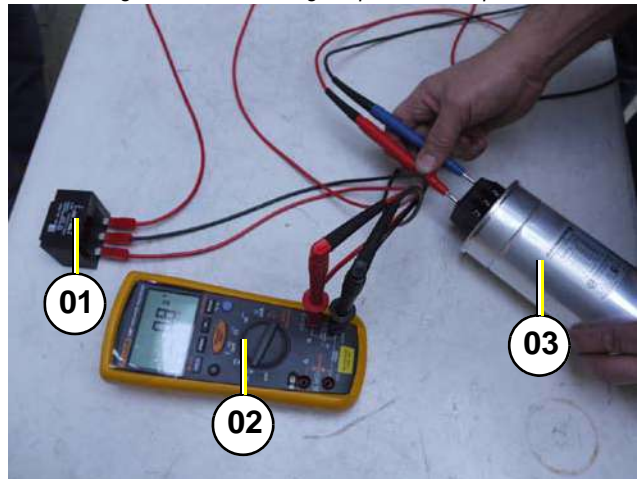
*Fig. 7.18.1-1: Discharge capacitor single phase*



**Discharge the capacitor - three phase**

- 01. Discharge reactor (5-10kOhm)
- 02. Multimeter
- 03. Capacitor

*Fig. 7.18.1-2: Discharge capacitor three phase*



At three phase capacitors the discharge must be made between every phase (L1-L2; L2-L3; L1-L3)



### Checking

Switch the multimeter to capacitor measuring and connect the meter end probes to the capacitor terminals. Measure capacity of the capacitor.

Fig. 7.18.1-3: Capacitor checking



### Check all capacitors in the electrical cabinet

Test each capacitor by touching the multimeter (set on capacitor measuring) probes on the capacitor terminals: measure the capacity of the capacitors.

The capacitors should not be removed from the electrical cabinet before the check is made.

### Checking the electrical connections to the Capacitor

It must be ensured that the electrical connections to the capacitor are always tight fitting. Loose connections with transitional resistance can mean that the contact surfaces will become heated externally. This can lead to faster deterioration of the capacitors.

## 7.19 Replacing the Electric Starter

The described procedure is representative for Fischer Panda generators. The original location of the item must be taken from the generator description of this manual. All replacements and repairs should be done by a trained person.

**Ensure that the generator cannot be started up accidentally. Remove battery main switch.**

For part numbers, refer to the spare parts catalogue.

1. Open the capsule.
  01. Electric starter

**NOTE: Representative procedure**



**ATTENTION!**



Fig. 7.19-1: Electric starter

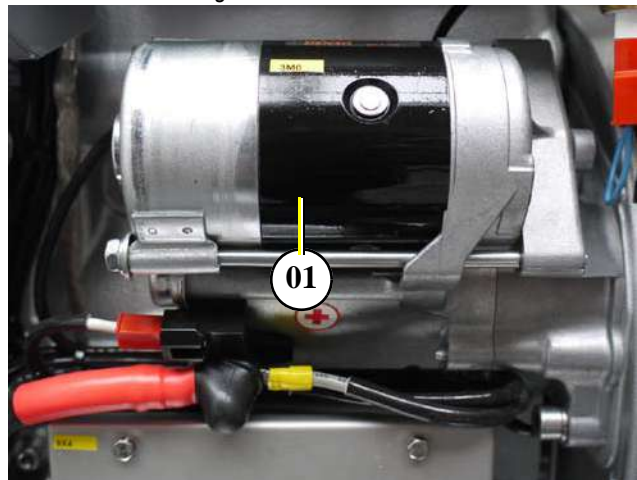


Fig. 7.19-2: Electric starter

2. Pull off connector.



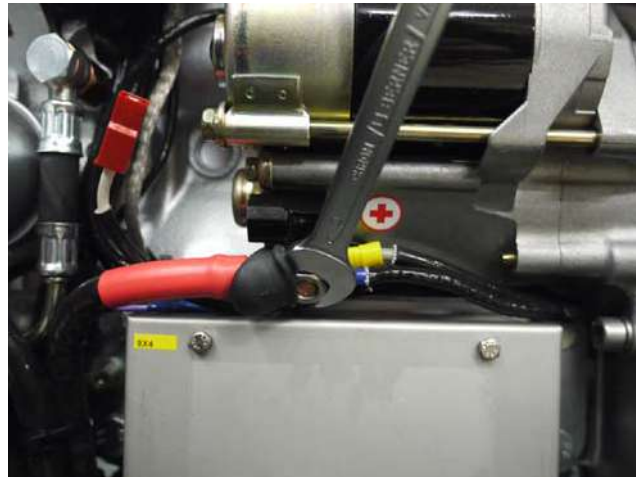




3. Pull off rubber cap.
4. Loosen hex nut with wrench with W.A.F. 13 mm and remove the electric connections.



Fig. 7.19-3: Electric starter



5. Loosen the lower attachment screw with a hex socket wrench.



Fig. 7.19-4: Electric starter



### Tools needed:

01. Socket wrench with long and short extension and size 6 mm socket

Fig. 7.19-5: Tools



The upper attachment screw is visible from up top, view between engine and exhaust manifold.

- Slide the socket wrench fitted with both extensions under the exhaust manifold and insert in the hex socket screw. Loosen upper attachment screw.

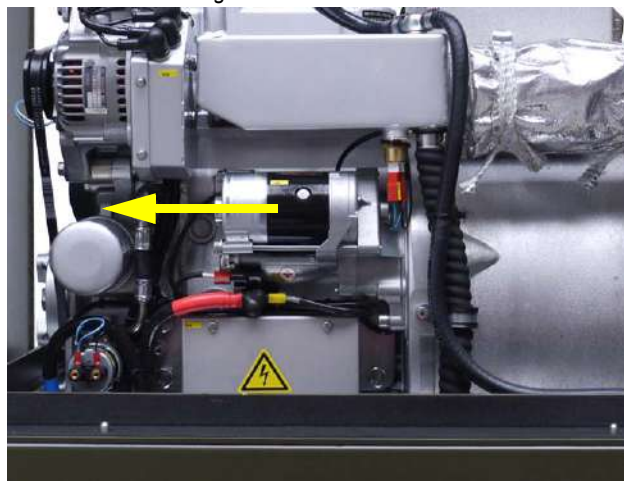


- Pull out electric starter.
- To reinstall, reverse the order of steps.

Fig. 7.19-6: Electric starter



Fig. 7.19-7: Electric starter





## 7.20 Replacing the DC/DC Converter

The described procedure is representative for Fischer Panda generators. The original location of the item must be taken from the generator description of this manual. All replacements and repairs should be done by a trained person.

**NOTE: Representative procedure**

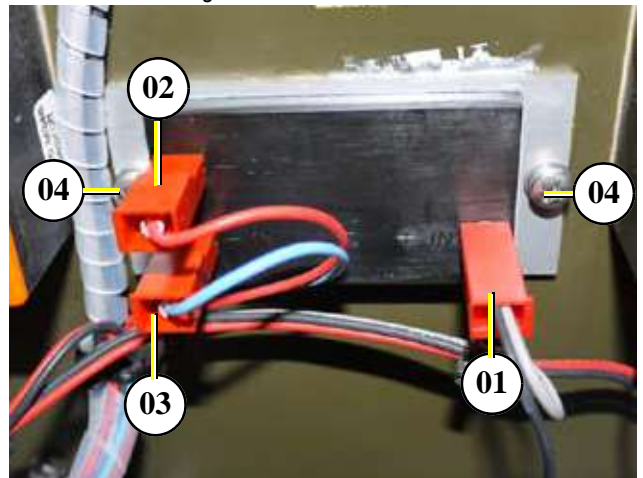


9. Disconnect the starter battery (first GND (-), then (+)).
10. Disconnect the three cable terminals.
11. Loosen the two filister head screws and dismount the DC/DC converter.
12. Proceed in the reverse order to reassemble.

01. 24V ...28.8V +
02. 12V ...14.4V +
03. GND -
04. Filister head screw with cross slot



Fig. 7.20-1: DC/DC converter



## 7.21 Replacing the DC Alternator

The described procedure is representative for Fischer Panda generators. The original location of the item must be taken from the generator description of this manual. All replacements and repairs should be done by a trained person.

**Ensure that the generator cannot be started up accidentally. Remove battery main switch.**

For part numbers, refer to the spare parts catalogue.

1. Open the capsule.
  01. DC alternator

**Figures similar!**

2. Remove cable ties.



**NOTE: Representative procedure**



**ATTENTION!**



Fig. 7.21-1: DC alternator

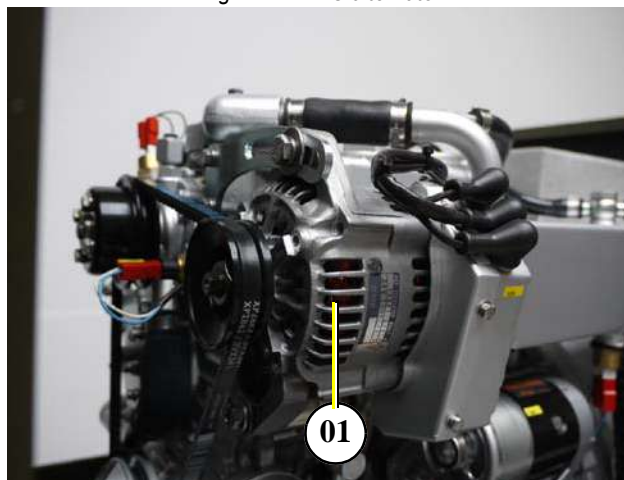


Fig. 7.21-2: DC alternator





3. Pull off rubber caps on the electrical terminals.
4. Remove nut and washer of the 24 V DP+ terminal (red cable) using a wrench with W.A.F. 10 mm.



Fig. 7.21-3: DC alternator



5. Remove nut and washer of the exciter terminal (grey cable) with a wrench with W.A.F. 8 mm.



Fig. 7.21-4: DC alternator



6. Remove nut and washer of the charging voltage fault terminal (green cable, bottom terminal) with a wrench with W.A.F. 8 mm.



Fig. 7.21-5: DC alternator

7. Loosen upper fixing screw of the DC alternator with a wrench with W.A.F. 13 mm.



8. Loosen bottom fixing screw of the DC alternator with a wrench with W.A.F. 12 mm (01).



9. Use a wrench with W.A.F. 12 mm (02) for the counter nut.



10. Push the DC alternator toward the thermostat housing.  
 11. Remove the V-belt.  
 12. Remove both fixing screws.

13. Remove spacer.

Fig. 7.21-6: DC alternator

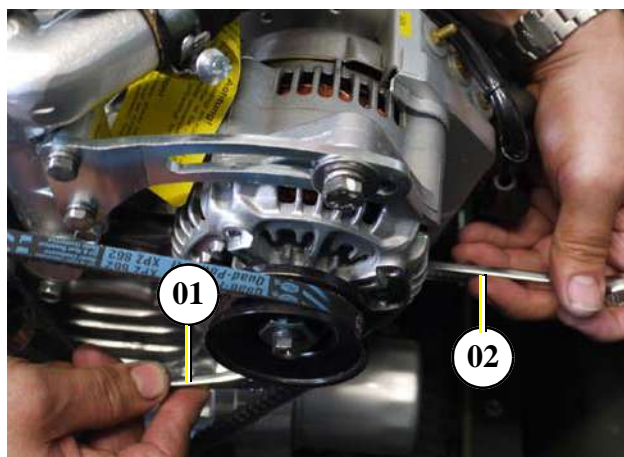


Fig. 7.21-7: DC alternator

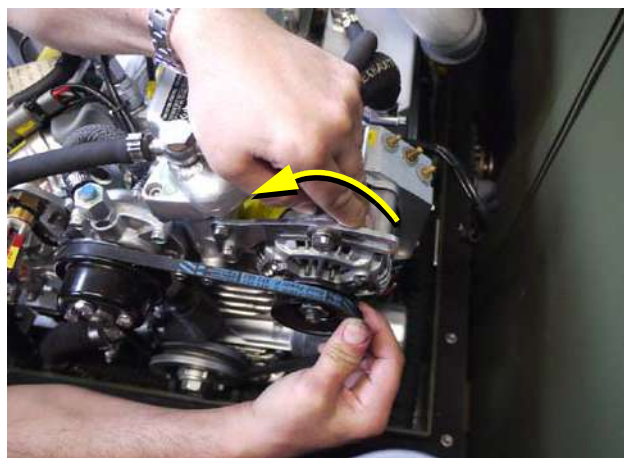
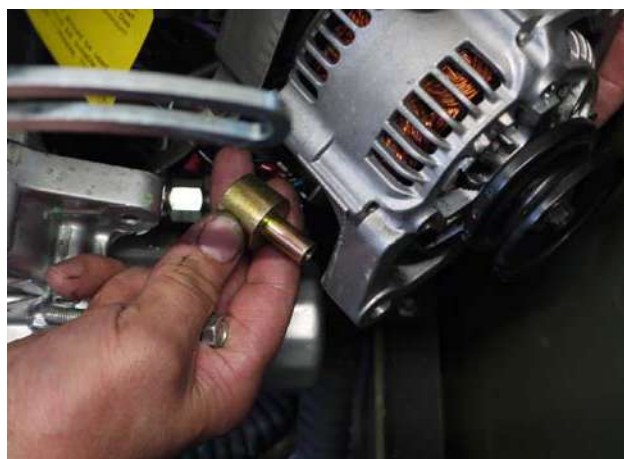


Fig. 7.21-8: DC alternator





14. Loosen and remove the earthing strip with a size 5 mm socket wrench.



15. Replace the DC alternator.

16. To reinstall, reverse the order of steps.

Fig. 7.21-9: DC alternator



## 7.22 Replacing the Oil Pressure Switch

The described procedure is representative for Fischer Panda generators. The original location of the item must be taken from the generator description of this manual. All replacements and repairs should be done by a trained person.

**Ensure that the generator cannot be started up accidentally. Remove battery main switch.**

For part numbers, refer to the spare parts catalogue.

1. Open both connectors (01) on the oil pressure switch.
2. Pull off rubber cap (02).

**NOTE: Representative procedure**



**ATTENTION!**



Fig. 7.22-1: Oil pressure sensor

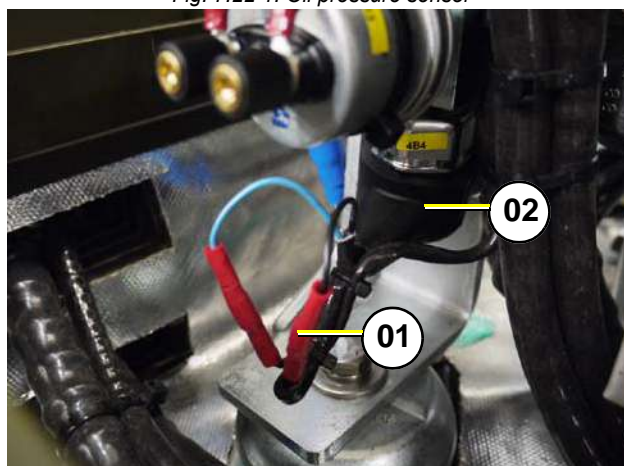


Fig. 7.22-2: Oil pressure sensor

3. Loosen and remove oil pressure switch 4B4 using a wrench with W.A.F. of 29 mm. A large piece of cloth or absorbent tissue must be placed under the connection to prevent escaping oil from running into the capsule.



4. To reinstall, reverse the order of steps. The switch is fitted with a tapered thread and requires no special seal.



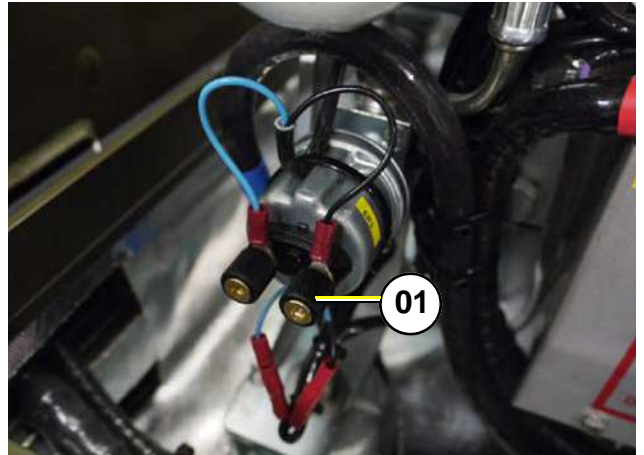




### 7.22.1 Replacing the oil pressure sensor (optional component)

1. Unscrew both connectors (01) on the oil pressure sensor.

Fig. 7.22.1-1: Oil pressure sensor



2. Loosen and remove oil pressure sensor 6R3 using a wrench with W.A.F. of 17 mm. A large piece of cloth or absorbent tissue must be placed under the connection to prevent escaping oil from running into the capsule.



To reinstall, reverse the order of steps. The sensor is fitted with a tapered thread and requires no special seal.

Fig. 7.22-2: Oil pressure sensor



## 7.23 Replacing the Operating Current Relays

The described procedure is representative for Fischer Panda generators. The original location of the item must be taken from the generator description of this manual. All replacements and repairs can be done by the user.

1. Remove the two fixing screws of the plastic cover using a size 0 or 1 phillips screwdriver.



**NOTE: Representative procedure**



Fig. 7.23-1: Relay



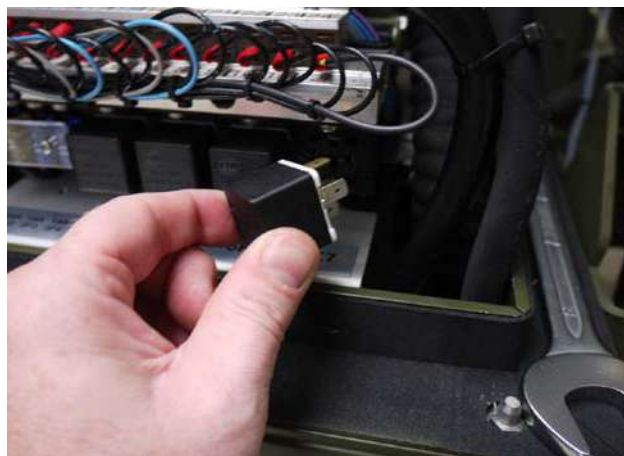
2. Remove the plastic cover.

Fig. 7.23-2: Relay



3. Pull relay from the socket and replace with new relay.
4. To reinstall, reverse the order of steps.

Fig. 7.23-3: Relay



## 7.24 Replacing the fuses

The described procedure is representative for Fischer Panda generators. The original location of the item must be taken from the generator description of this manual. This replacement can be done by the user.

**NOTE: Representative procedure**



The fuses should be replaced every 2000 operating hours.

### Figures similar!

1. Remove the two fixing screws of the plastic cover using a size 0 or 1 phillips screwdriver.

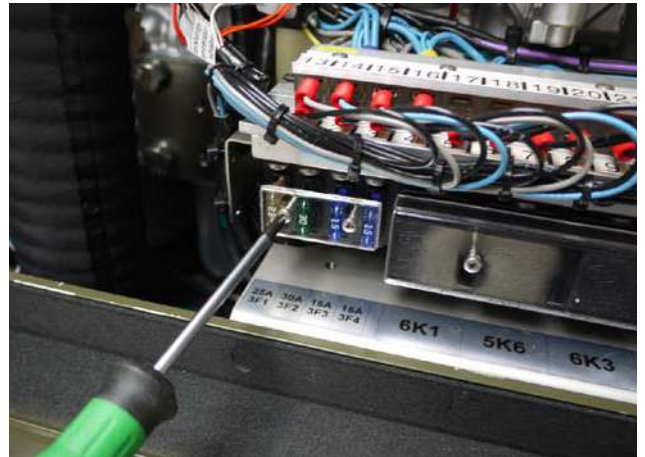


Fig. 7.24-1: Fuse

2. Remove the plastic cover.

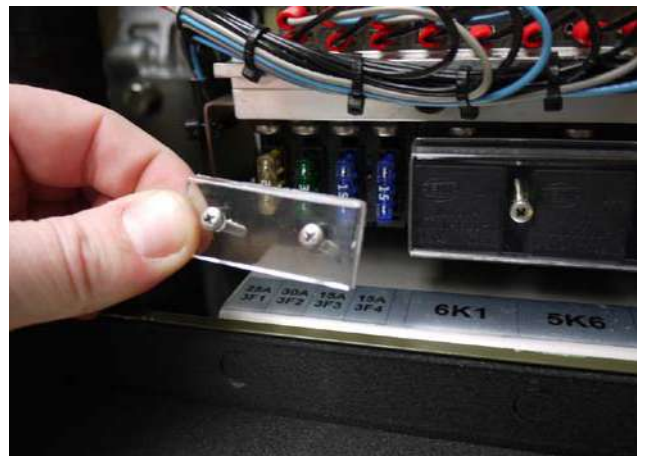


Fig. 7.24-2: Fuse

3. Using the fuse extraction tool, remove the fuse and replace it with a new one.

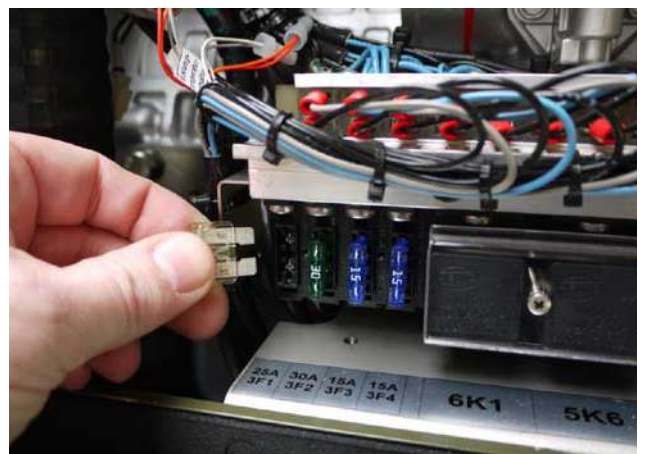


Fig. 7.24-3: Fuse

4. To reinstall, reverse the order of steps.

## 7.25 Replacing a Thermoswitch

The described procedure is representative for Fischer Panda generators. The original location of the item must be taken from the generator description of this manual. All replacements and repairs should be done by a trained person.

**Ensure that the generator cannot be started up accidentally. Remove battery main switch.**

For part numbers, refer to the spare parts catalogue.

1. Open the capsule.
  01. Thermoswitch

**NOTE: Representative procedure**



**ATTENTION!**



Fig. 7.25-1: Thermoswitch

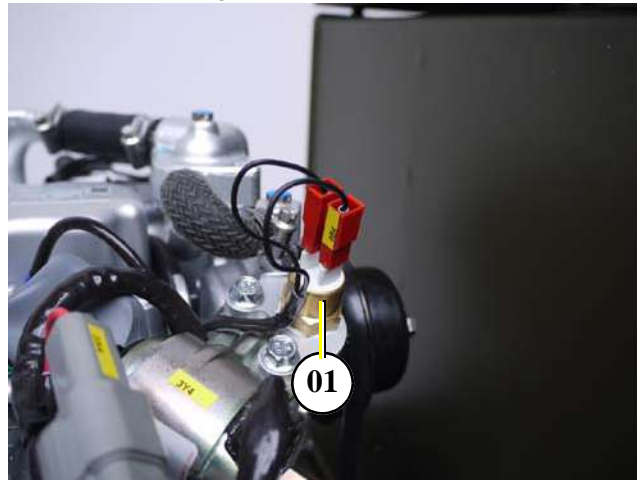


Fig. 7.25-2: Thermoswitch

2. Remove cable ties.



3. Disconnect electric supply line of the thermostat.

Fig. 7.25-3: Thermostat



4. Loosen thermostat with a wrench with W.A.F. 22 mm.



Fig. 7.25-4: Thermostat



5. Before installing the new thermostat, check the label for correct item.

Fig. 7.25-5: Thermostat

6. To reinstall, reverse the order of steps.



## 7.26 Replacing the Injection Nozzles

The described procedure is representative for Fischer Panda generators. The original location of the item must be taken from the generator description of this manual. All replacements and repairs should be done by a trained person.

**Ensure that the generator cannot be started up accidentally. Remove battery main switch.**

### Injection lines

Figures similar!

1. Remove cable ties from the injection lines.



2. Loosen the pipe clamps (1) using a PH2 phillips screwdriver.



**NOTE: Representative procedure**



**ATTENTION!**



Fig. 7.26-1: Injection nozzles

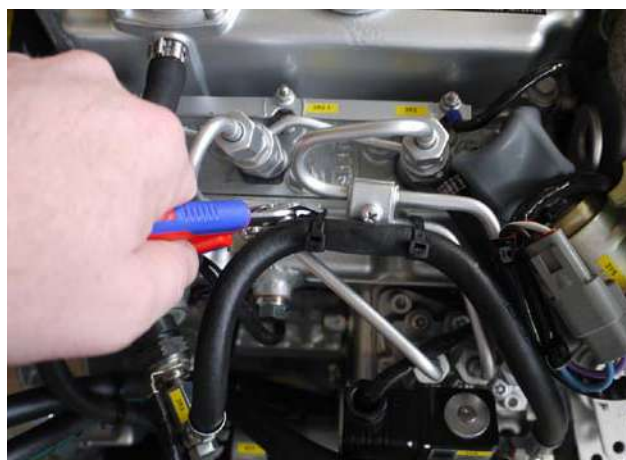
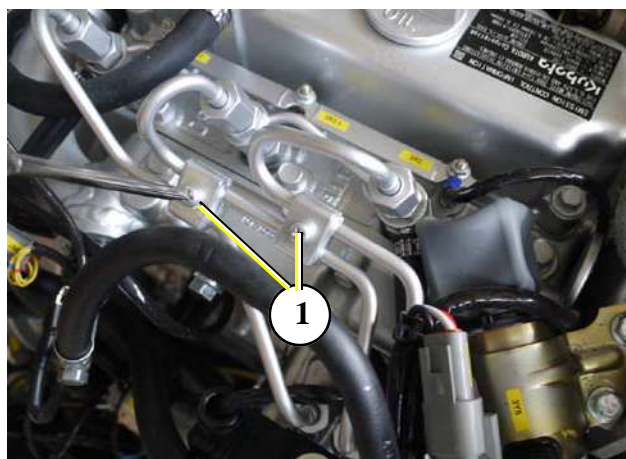


Fig. 7.26-2: Injection nozzles



3. Loosen the union nut on the injection lines (1). Wrench with W.A.F. of 17 mm.



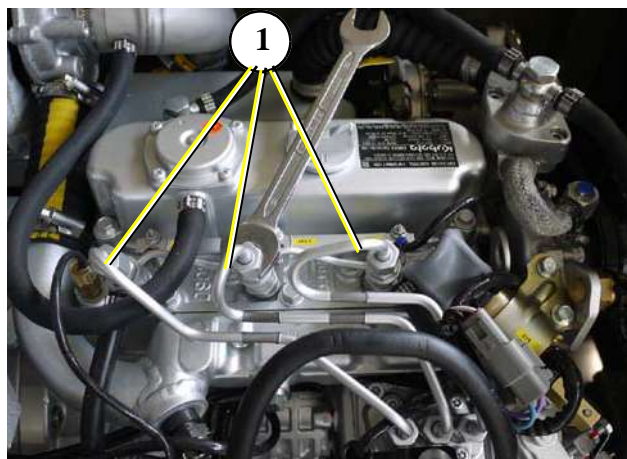
**For assembly:**

- Blast dust out of the lines using compressed air. Then, re-assemble the lines by proceeding in the reverse order of steps.

(1) Injection line

Torque	Injection line union nut	24.5 to 34.3 Nm 2.5 to 3.5 kgm 18.1 to 25.3 pound-foot
--------	--------------------------	--

Fig. 7.26-3: Injection nozzles



**Nozzle holder assembly and glow plug**

1. Dismount the return line (1). Wrench with W.A.F. of 17 mm.
2. Remove the nozzle holder assembly (4). Wrench with W.A.F. of 21 mm.
3. Remove the copper seal (5) and the heat shield (6).
4. Dismount the connector (2) from the glow plugs (3)
5. Remove the glow plugs (3).

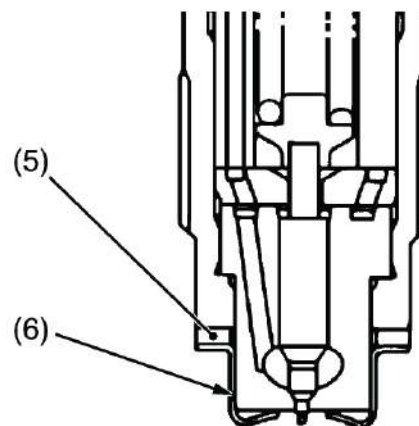
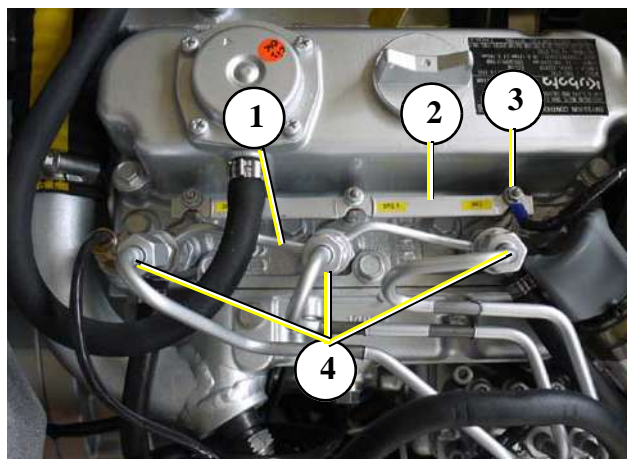
**For assembly:**

- Replace the copper seal and the heat shield with new parts.

- (1) Return line
- (2) Connector
- (3) Glow plug
- (4) Nozzle holder assembly
- (5) Copper seal
- (6) Heat shield

Torque	Fixing nut for overflow oil line	19.6 to 24.5 Nm. 2.0 to 2.5 kgm 14.5 to 18.1 pound-foot
	Nozzle holder assembly	49.0 to 68.6 Nm 5.0 to 7.0 kgm 36.2 to 50.6 pound-foot
	Glow plug	7.8 to 14.7 Nm. 0.8 to 1.5 kgm 5.8 to 10.8 pound-foot

Fig. 7.26-4: Injection nozzles



### Removing the nozzle heat shield ring seal within the scope of the maintenance work.

#### IMPORTANT!

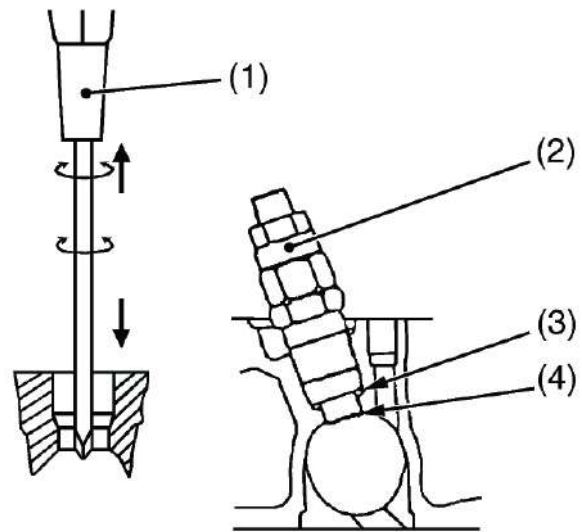
- Use a phillips screwdriver (1) with a diameter greater than the hole in the heat ring seal (approx. 6 mm (1/4 in)).
1. Lightly turn the screwdriver (1) into the hole in the heat ring seal.
  2. Rotate the screwdriver three to four times in each direction.
  3. When rotating the screwdriver, slowly extract the heat ring seal (4) together with the injection nozzle gasket (3).
  4. If the heat ring seal drops back in, repeat the procedure above.

#### For assembly:

- If the injection nozzle is uninstalled for cleaning or maintenance purposes, the heat seal ring and the injection nozzle gasket must be replaced.

- (1) Phillips screwdriver (2) Injection nozzle  
 (3) Injection nozzle gasket (4) Heat ring seal

Fig. 7.26-5: Injection nozzles







## 7.27 Checking the Flame Glow Plug (optional unit)

The described procedure is representative for Fischer Panda generators. The original location of the item must be taken from the generator description of this manual. All replacements and repairs should be done by a trained person.

**NOTE: Representative procedure**

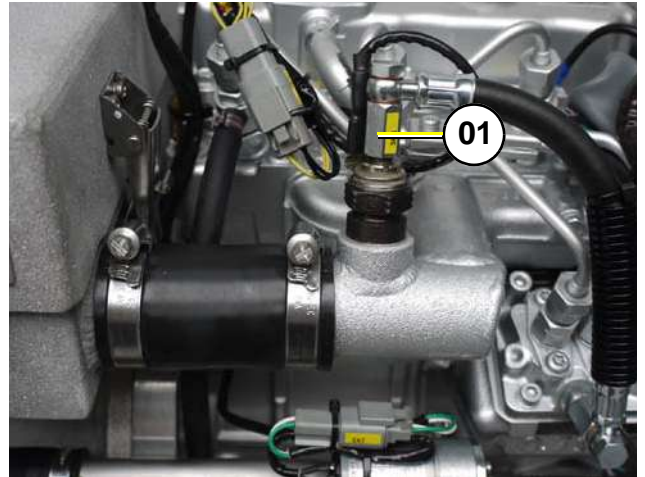


### 01. Flame glow plug

#### Symptoms indicating a faulty start-up aid:

- Hesitant start-up
- Black exhaust smoke
- Irregular operation
- Increased fuel consumption, engine is „knocking“.

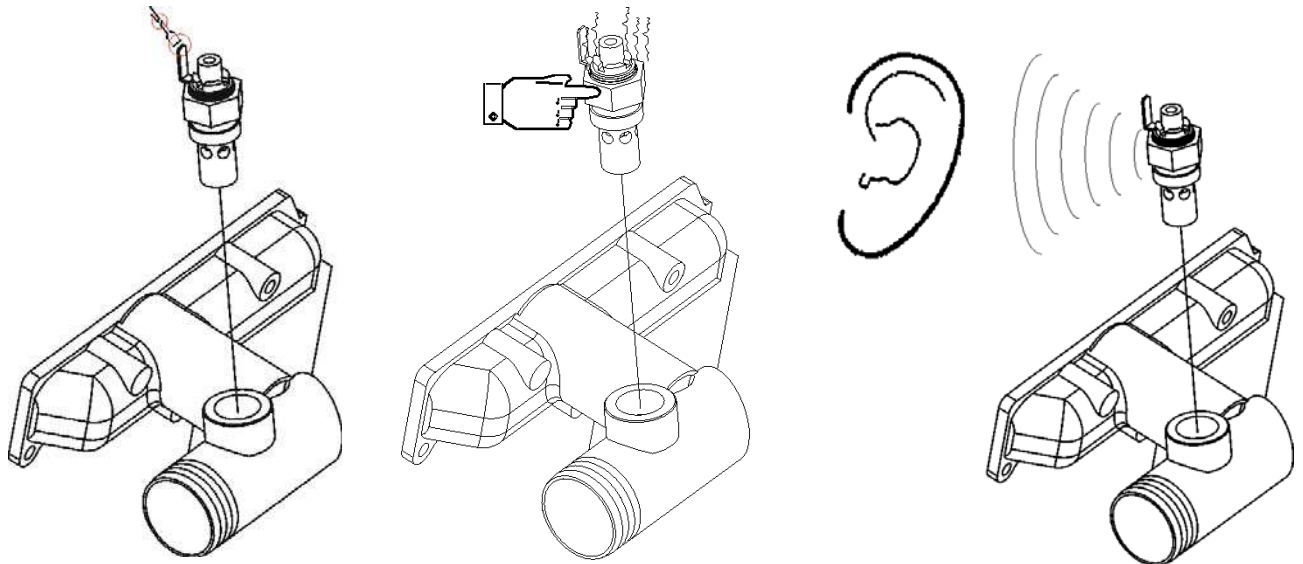
Fig. 7.27-1: Flame glow plug



#### Electrical test

1. Check cable connections.
2. Check power consumption: approx. 8A.
3. Uninstall and check intake port for diesel residue. Replace flame glow plug if necessary.

Fig. 7.27-2: Flame glow plug



### 7.27.1 Replacing the Flame Glow Plug

The described procedure is representative for Fischer Panda generators. The original location of the item must be taken from the generator description of this manual. All replacements and repairs can be done by the user.

**NOTE: Representative procedure**



1. Pull connector off the flame glow plug.

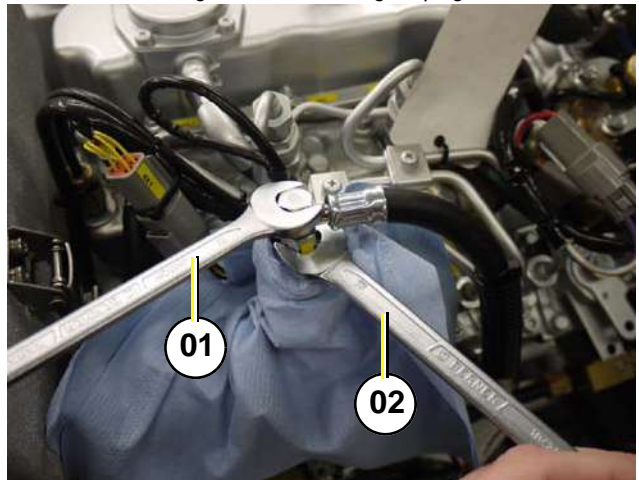
Fig. 7.27.1-1: Flame glow plug



2. A large piece of cloth or absorbent tissue must be placed under the connection to prevent escaping fuel from running into the capsule.

Fig. 7.27.1-2: Flame glow plug

3. Loosen the screw on the flame glow plug using a wrench with a W.A.F of 12 mm (01).



Use a wrench with a W.A.F of 13 mm (02) for the counter nut.



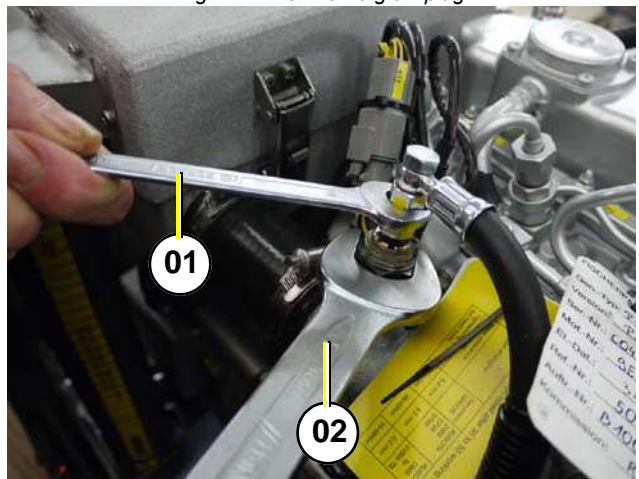
4. Remove the fuel hose.

5. Loosen flame glow plug with a wrench with W.A.F. of 13 mm (01) and remove flame glow plug.

Fig. 7.27.1-3: Flame glow plug



Use a wrench with a W.A.F of 24 mm (02) for the counter nut.



6. To reinstall, reverse the order of steps.



## 7.28 Replacing the Stop Solenoid (Energize to stop)

The described procedure is representative for Fischer Panda generators. The original location of the item must be taken from the generator description of this manual. All replacements and repairs should be done by a trained person.

**NOTE: Representative procedure**



**Ensure that the generator cannot be started up accidentally. Remove battery main switch.**

**ATTENTION!**



For part numbers, refer to the spare parts catalogue.

1. Open the capsule.
  01. Stop solenoid

Fig. 7.28-1: Stop solenoid

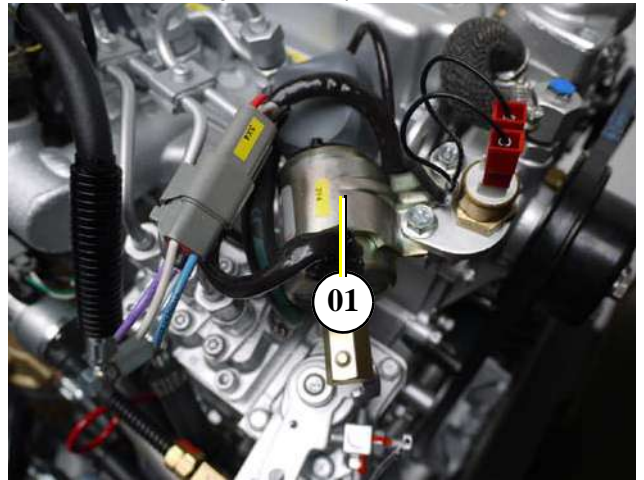


Fig. 7.28-2: Stop solenoid

2. Remove cable ties.



3. Disconnect electric supply line 3X4 from the stop solenoid.

Fig. 7.28-3: Stop solenoid



4. Remove cable ties.

Fig. 7.28-4: Stop solenoid



5. Remove the two fixing screws using a size 10 mm socket wrench.

Fig. 7.28-5: Stop solenoid





6. Replace the stop solenoid.
7. To reinstall, reverse the order of steps.

Fig. 7.28-6: Stop solenoid



**Please note for reinstallation:**

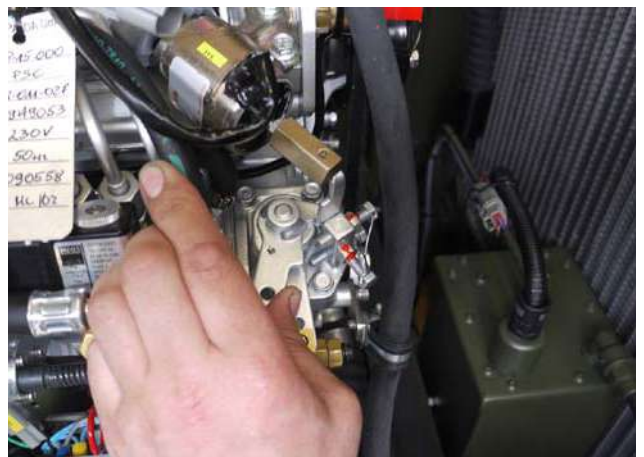
8. Slide the pin into the throttle.

Fig. 7.28-7: Stop solenoid



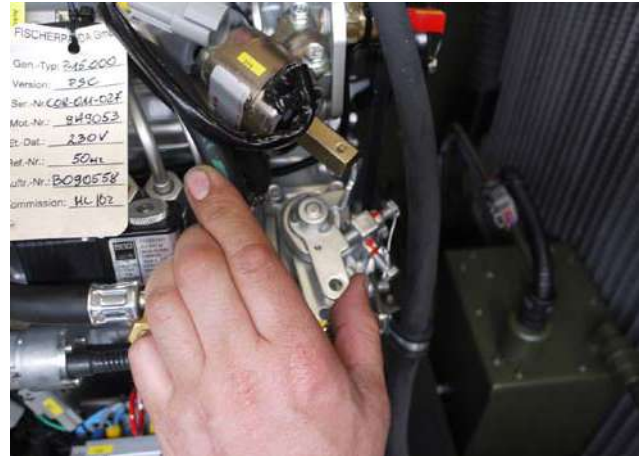
9. Push the throttle to the left and release.

Fig. 7.28-8: Stop solenoid



10. Ensure that the throttle jumps back to its starting position without friction .

Fig. 7.28-9: Stop solenoid



## 7.29 Replacing the Glow Plugs

The described procedure is representative for Fischer Panda generators. The original location of the item must be taken from the generator description of this manual. All replacements and repairs should be done by a trained person.

**NOTE: Representative procedure**



**Ensure that the generator cannot be started up accidentally. Remove battery main switch.**

**ATTENTION!**



1. Open the capsule.
  01. Glow plugs

Fig. 7.29-1: Glow plugs

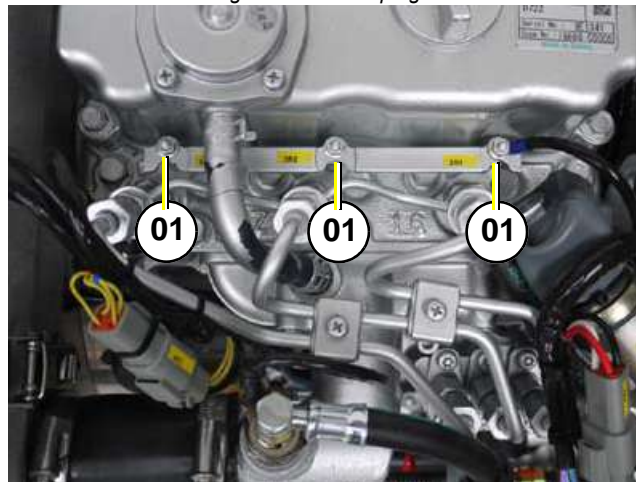
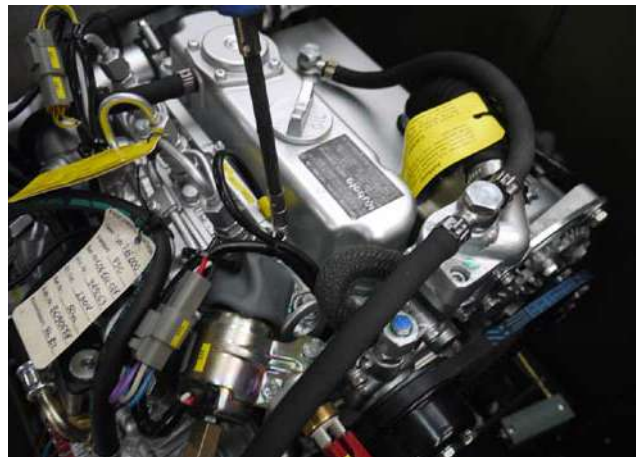


Fig. 7.29-2: Glow plugs

**Figures similar!**

2. Remove the three hex screws using a size 7 mm socket wrench .



3. Remove the glow plug connector.

Fig. 7.29-3: Glow plugs



4. Loosen the glow plug using a socket wrench with a long size 10 mm socket.



Fig. 7.29-4: Glow plugs

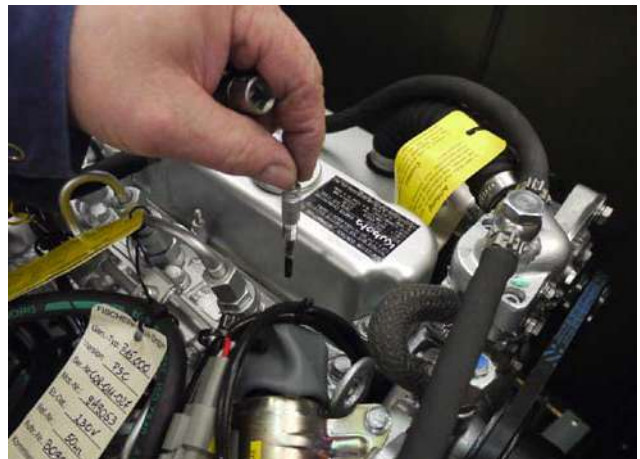


Leere Seite / Intention

5. Remove glow plug.

Fig. 7.29-5: Glow plugs

6. To reinstall, reverse the order of steps.





## 8. Generator Faults

### 8.1 Personal requirements

---

The work described here, unless otherwise indicated, are performed by the operator.

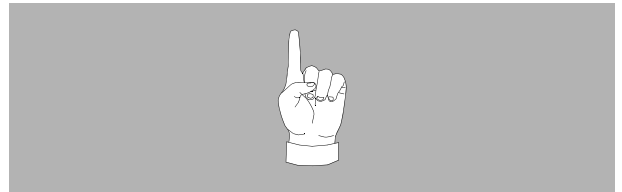
More repair work may be performed only by specially trained personnel or by authorized repair shops (Fischer Panda service points). This is especially for working on the valve timing, fuel injection system and the engine repair.

### 8.2 Hazard notes for the troubleshooting

---

Follow the general safety instruction at the front of this manual.

Notice!:



**Danger for life! - The generator can be equipped with an automatic start device. This means the generator can be started by an external signal. To avoid an unexpected starting of the generator, the starter battery must be disconnected before start working at the generator.**

Warning!: Automatic start



**Working at a running generator can result in severe personal injury. Therefore before starting work at the generator:**

Warning!: Risk of injury



Make sure that the generator is stopped and the starter battery is disconnected to guarantee that the generator cannot be inadvertently started.

Do not run the generator with removed sound isolation cover.

**Improper installation/maintenance can result in severe personal injuries or material damage.**

Warning!: Risk of injury



- Always undertake installation/maintenance work when the generator is switched off.
- Ensure there is sufficient installation clearance before start working.
- Ensure tidiness and cleanliness at the workplace. Loose components and tools lying around or on top of each other are sources of accidents.
- Only perform installation work using commercially available tools and special tools. incorrect or damaged tools can result injuries.

**Oil and fuel vapours can ignite on contact with ignition sources. Therefore:**

- No open flames during work on the generator.
- Do not smoke.
- Remove oil and fuel residues from the generator and floor.

**Contact with engine oil, antifreeze and fuel can result in damage to health. Therefore:**

- Avoid skin contact with engine oil, fuel and antifreeze.
- Remove oil and fuel splashes and antifreeze from the skin immediately.
- Do not inhale oil and fuel vapours.

**Danger for Life. Improper handling, operation, installation and maintenance can result in severe personal injury and/or material damage.**

Electrical voltages above 48 volts (battery chargers greater than 36 volts) are always dangerous to life). The rules of the respective regional authority must be adhered to. Only an electrician may carry out installation of the electrical connections for safety reasons.

**Generator, oil and antifreeze can be hot during/after operation. Risk of severe burns.**

**During Installation/maintenance personal protective equipment is required to minimize the health hazards.**

- Protective clothing
- safety boots
- protective gloves
- Ear defender
- safety glasses

**Disconnect all load during the work at the generator to avoid damages at the load.**

**Warning!: Danger of fire**



**Danger!: Danger of poisoning**



**ATTENTION!: Danger to Life - High voltage**



**Warning!: Hot surface/material**



**Instruction!: Personal protective equipment necessary.**



**Attention!: Disconnect all load**



### **8.3 Tools and Measuring Instruments**

---

**In order to be able to manage disturbances while driving, the following tools and measuring instruments should belong to the equipment kept on board:**

- Multimeter for voltage (AC), frequency and resistance
- Measuring instrument for inductance
- Measuring instrument for capacity
- Current absorbing clamps
- Thermometer (ideal is a infra-red thermometer)
- Pressure device (pincer) for coolant circuit



### 8.4 Troubleshooting Table and Flowchart

#### 8.4.1 Generator output voltage too low

For 50 Hz versions: less than 200 V

Cause	Solution
Generator is overloaded.	Reduce the electrical load (switch off load)
Motor is not reaching the rated rpm.	Refer to „motor faults“ section.
Defective capacitor(s).	Check capacitors and replace if necessary.

#### 8.4.2 Generator voltage too high (more than 240 V - 50 Hz)

Cause	Solution
Over-energizing due to wrong capacitors.	Check capacitors type and replace if necessary.
Measuring voltage on the VCS circuit board is missing.	Check VCS System, check cable connections.

#### 8.4.3 Generator voltage fluctuates

Cause	Solution
1. Disturbances on the electrical system/user side. 2. Motor disturbances.	1. Check if electrical load is fluctuating. 2. Refer to section: „Motor runs irregular“.

#### 8.4.4 Generator not able to start electric motor

Cause	Solution
If the generator is unable to supply enough power to start an electric motor 1-phase, it is usually because the motor draws too much current during starting process.	Check the motor's current draw required for starting (switch to 3-phase, if possible). This could be remedied by providing stronger capacitors or installing an optional „Easy Start Booster Set“ (see Appendix). Enquire at your nearest Panda dealer or directly at the manufacturer.

#### 8.4.5 Diesel motor fails to start

Cause	Solution
Starter battery switched „OFF“.	Check position of battery switch and switch „ON“ (if installed).
Starter battery voltage insufficient (battery too weak).	Inspect battery terminals and cables for a good electrical connection (Inspect against corrosion, tattered wires, etc.).
Starting current disrupted.	During the normal starting process, the battery voltage drops to 11V with a fully charged battery. If the voltage does not drop during starting, the electrical connection is faulty. If the battery voltage drops lower than 11V, then the battery has been discharged.

#### 8.4.6 Starter is turning motor, but fails to start

Cause	Solution
Fuel inlet solenoid valve not opening.	Check wire connections and circuitry to solenoid valve. (ref. DC wiring diagram: Relay K2, Fuse)
Fuel pump not working.	Check fuel-filter and pump: clean if necessary.

Cause	Solution
Lack of fuel.	Check fuel supply.
Glow-plugs not working correctly.	Check glow plugs and heating time.
Too much air in fuel lines.	Test fuel system for leakage. Bleed air from fuel system (refer to section „Bleeding Air from Fuel System“).
Fuel-filter blocked.	Replace fuel filter.

### 8.4.7 Motor does not achieve enough speed during starting process

Cause	Solution
Starter battery voltage insufficient.	Check battery.
Damaged bearing(s) piston (seized).	Repairs need to be carried out by Kubota-Service. (refer to Kubota motor-manual)
Cooling water in combustion chamber.	<ol style="list-style-type: none"> <li>1. Turn generator „OFF“ at control panel.</li> <li>2. Remove the glow plug (see Kubota-manual).</li> <li>3. Rotate the motor by hand carefully.</li> <li>4. Check if there is water in the oil and change both oil and filter if necessary.</li> <li>5. Determine cause for excess water in the combustion chamber. The excess water can be caused by a defective air vent in the cooling water system, which should be checked and cleaned, or replaced if faulty.</li> </ol>

### 8.4.8 Motor runs unsteady

Cause	Solution
Disruption in the area of the injection systems' automatic advance.	Repair / Check the automatic advance via the motor service.
Air in the fuel system.	Ventilate the fuel system.

### 8.4.9 Motor speed drops

Cause	Solution
Lack of fuel	Check fuel supply system: - fuel filter, renew if necessary - check fuel pump - check fuel lines (bleed if necessary)
Lack of intake air.	Check air intake paths. Check and clean air filter (and intake muffler if installed).
Generator overloaded by too many load.	Reduce the electrical load (switch off load).
Generator overloaded by over-energizing.	Check that the proper capacitor type is installed and that they are connected correctly.
Defective generator (windings, bearings, or other).	Generator must be sent to manufacturer for repair of damaged bearings or winding.
Damaged engine.	Repair of bearing damage, etc., by Kubota-Service.

### 8.4.10 Motor runs in off position

Cause	Solution
Fuel inlet solenoid valve or throttle shut solenoid is not switching off.	Check wire connections to solenoid. Check valve functions as in the „Fuel Solenoid Valve“ or in the throttle shut off solenoid sections. Replace if necessary.



### 8.4.11 Motor stops by itself

Cause	Solution
Lack of fuel.	Check fuel supply system.
Excess heat in cooling system (thermo switch tripped)-lack of cooling water. Is indicated on the remote control panel.	Check cooling water system flow: water pump, inlet water filter, extra heat exchanger coolant flow.
Lack of oil pressure sensor tripped). Is indicated on the remote control panel.	Check oil-level and if necessary top up. Check motor's oil-pressure and have repaired by Kubota-Service if necessary.

### 8.4.12 Sooty, black exhaust

Cause	Solution
Generator is overloaded.	Check electrical load and switch off unnecessary load.
Insufficient intake air.	Check intake air filter; clean if necessary.
Fuel injector faulty.	Replace injector.
Valve clearance incorrect.	Readjust valve clearance to correct value (refer to Farymann-manual).
Poor fuel quality.	Use better quality diesel (recommended: 2-D Diesel).
Poor combustion.	Incorrect AFR (air/fuel ratio) due to motor timing adjustment. Have motor serviced by Kubota.

### 8.4.13 Generator must be shut off immediately if:

Cause	Solution
<ul style="list-style-type: none"> <li>- motor rpm suddenly rises or drops</li> <li>- unusual noise comes from genset</li> <li>- exhaust colour suddenly becomes dark</li> <li>- leakage in the cooling water system.</li> </ul>	Refer to respective section of manual and if necessary, have repaired by Kubota-Service, or Panda representative.

### 8.4.14 Troubleshooting for the VCS-Voltage Control

Cause	Solution
No movement of the actuator.	Voltage supply for electronics active? Motor connected? 230 V measurement voltage attached?
Actuator controls in idle speed or full throttle.	Correct or change polarity of the motor. 230 V measurement voltage attached?
<p>If it occurs that all electronic components break down or any other failure emerges, the generator can still be operated when the electronic system is overridden. For this the plug is pulled out and the two cables are tide over it.</p> <p>1. Loosen the speed lever between motor and injection pump controller and adjust to max. 240 V. OR</p> <p>2. Loosen connection plus motor VCS-electronic, directly feed the motor with 12 V voltage and adjust to max. 240 V.</p>	

8.4.15 Troubleshooting Flowcharts

Fig. 8.4.15-1: Troubleshooting Flowchart - Page 1

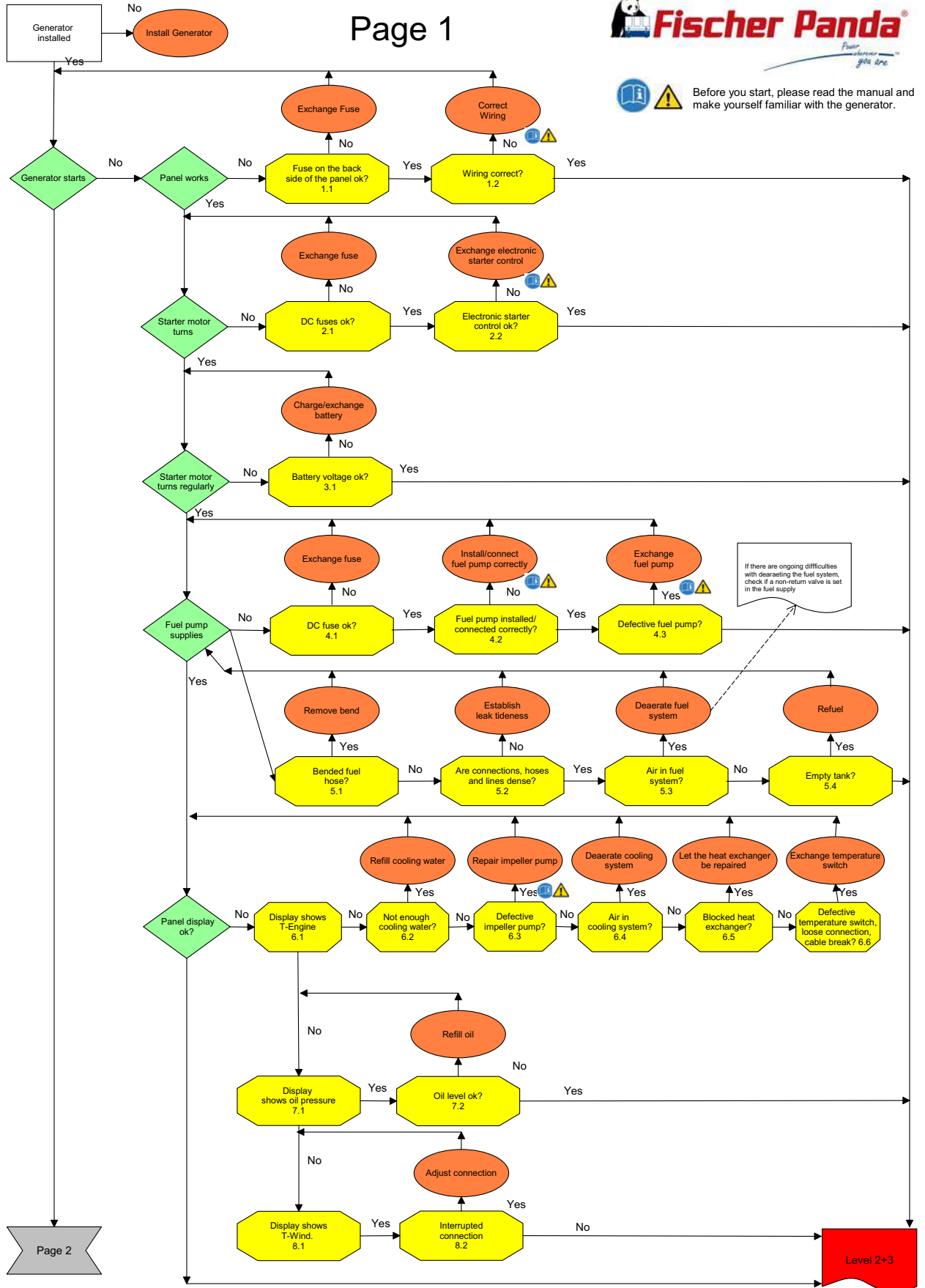




Fig. 8.4.15-2: Troubleshooting Flowchart - Page 2



### Page 2



Trouble shooting flowchart Marine Rev2.1



### 8.4.15.1 Details and explanations concerning the troubleshooting flowchart

Each failure position in the flowchart above contains a reference number.

With this reference number, the corresponding work steps can be taken from the list below.

#### 1.1 Fuse at the remote control panel.

Execute the fuse exchange as indicated in the data sheet of your remote control panel. Please note that not all remote control panels do have a corresponding fuse.

#### 1.2 Correct the wiring.

Get the wiring of the generator and the wiring of the external components checked according to the installation instructions in this manual and the data sheets, as well as descriptions of the external components and correct them if necessary.

**These operations are to be executed by a trained professional only! Attention: Voltage up to 400V - Danger to life!**



#### 2.1 Exchange DC fuse (Fuse for the starter circuit) - see wiring scheme

Exchange the relevant fuses at the generators' terminal block.

A defective fuse is not always visually detectable. Measure the fuse with a multimeter for connecting passage.

#### 2.2 Exchange anti-repeat starter device.

Loosen the connecting plug of the anti-repeat starter device.

Loosen the holding screws of the anti-repeat starter device.

Mount the new anti-repeat starter device in reversed order.

#### 3.1 Charge/exchange starter battery.

Proceed according to battery manufacturer instructions.

#### 4.1 Exchange DC fuse (Fuse for the fuel pump) - see wiring scheme

Exchange the relevant fuses at the generators' terminal block.

A defective fuse is not always visually detectable. Measure the fuse with a multimeter for connecting passage.

#### 4.2 Correct mounting/connection of the fuel pump.

Check the appropriate polarity at the connections and the tight fit of the connections at the fuel pump.

#### 4.3 Exchange fuel pump.

Loosen the electric connections of the fuel pump.

Loosen the holding screws of the fuel pump.

Mount the new fuel pump in reversed order.

#### 5.1 Remove buckling from the fuel hose.

Remove any buckling and improve the installation to avoid further disruptions.

#### 5.2 Sealing the connections.

Seal the system in an appropriate way. The system has to be checked for leakage at frequent intervals.

#### 5.3 Ventilating the fuel system.

Ventilate the fuel system as stated in the chapter 'Installation'. If air keeps entering into the fuel system, this might be an indication for a leaking connection or porous hoses. Then the fuel system should be inspected by a professional.

#### 5.4 Refuelling

Refuel your vehicle/the generator as described in the board manual.

**6.2 Refill cooling water.**

Refill the cooling water as described in the chapter Maintenance'.

**6.3 Defective impeller pump.**

Replace the defective impeller as described in the chapter Maintenance'.

**6.4 Air in the cooling system.**

Ventilate the cooling system as described in the chapter Maintenance'.

**6.5 Heat exchanger blocked.**

Get the heat exchanger repaired at a Fischer Panda Service point/Service Centre.

**6.6 Defective temperature switch, possibly loose contact/cable break.**

Get the temperature switch repaired at a Fischer Panda Service point/Service Centre.

**7.2 Oil level too low.**

Refill oil as described in the chapter Maintenance'.

**8.2 Connection assembly interrupted.**

Repair the connection assembly.

**9.1 Defective cable to the AC-Box.**

Get the cable to the AC-Box exchanged by a Fischer Panda Service point/Service Centre.

**The operations are to be executed by a trained professional only!**

**Attention: Voltage up to 400V - Danger to life!**

**9.2 Defective cable AC out.**

Get the cable AC out exchanged by a Fischer Panda Service point/Service Centre.

**The operations are to be executed by a trained professional only!**

**Attention: Voltage up to 400V - Danger to life!**

**9.3 Defective consumer load.**

Exchange consumer load/do not operate anymore.

**9.4 Missing residual magnetism.**

Let the residual magnetism be restored.

**The operations are to be executed by a trained professional only!**

**Attention: Voltage up to 400V - Danger to life!**

**10.1 Air in the fuel system.**

Ventilate the fuel system as described in the chapter Installation'.

**10.2 Defective DC fuse fuel pump**

Exchange the relevant fuses at the generators' terminal block.

A defective fuse is not always visually detectable. Measure the fuse with a multimeter for connecting passage.

**10.3 Incorrect attachment of the fuel pump.**

Get the installation corrected at a Fischer Panda Service point/Service Centre.

**10.4 Defective fuel pump.**

Get the fuel pump exchanged at a Fischer Panda Service point/Service Centre.

**10.5 Buckled fuel hose.**

Arrange the fuel hose in a way that no buckles can form.

**10.6 Leaky connections/pipes.**

Seal the connections professionally - Exchange leaky pipes.

**11.1 Actuator arbor is jammed.**

Check the Max/Min-adjustments and grease the actuator arbor, as described in the chapter Generator Faults'.

**11.2 Connection assembly actuator disrupted.**

Rebuild connection assembly.

**11.3 Defective DC fuse on the VCS.**

Get the relevant fuses exchanged at a Fischer Panda Service point/Service Centre.

The exchange is described in the chapter Generator Faults'.

A defective fuse is not always visually detectable. Measure the fuse with a multimeter for connecting passage.

**The operations are to be executed by a trained professional only!**

**Attention: Voltage up to 400V - Danger to life!**

**11.4 Disrupted measuring voltage to VCS.**

Get the measuring voltage cable connected/exchanged by a Fischer Panda Service point/Service Centre.

**The operations are to be executed by a trained professional only!**

**Attention: Voltage up to 400V - Danger to life!**

**11.5 Generator is overloaded.**

Reduce the load. Ensure that the generator does not get overloaded.

**12.1 Air in the fuel system.**

See 10.1

**12.2 Lack of fuel**

Re-assemble the fuel supply.

**12.3 Faults in the redundant temperature circuit.**

Get the temperature switch as well as the connection assemble and electric cables checked and repaired by a Fischer Panda Service point/Service Centre

**12.4 Generator is overloaded.**

See 11.5

**13.1 Lack of cooling water.**

Refill the cooling water as described in the chapter Maintenance'.

**13.2 Defective impeller pump.**

Replace the defective impeller as described in the chapter Maintenance'.

**13.3 Air in the cooling system.**

Ventilate the cooling system as described in the chapter Maintenance'.

**13.4 Heat exchanger blocked.**

Get the heat exchanger checked and repaired by a Fischer Panda Service point/Service Centre.

**13.5 Defective temperature switch, possibly loose contact/cable break.**

Get the temperature switch checked and repaired by a Fischer Panda Service point/Service Centre.

**13.6 Leaky ventilation screw.**

Renew the ventilation screw sealing.

**14.1 Oil level too low.**

Refill oil as described in the chapter 'Maintenance'.

**14.2 Defective oil pressure switch.**

Get the oil pressure switch exchanged by a Fischer Panda Service point/Service Centre.

## 8.5 Versions of the generator power terminal box

### Generator Power Terminal Box 230 V / 50 Hz

In these terminal box there are the electrical connection points for the AC generator. Here is also the bridge for the protective grounding of the generator. The cover may only be removed, if it is guaranteed that the generator cannot be inadvertently started.

Sample picture

Fig. 8.5.0-1: Generator output terminal box 230 V / 50 Hz

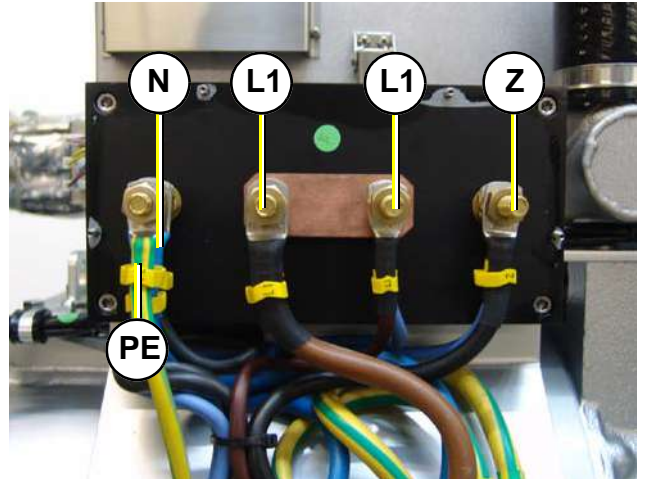
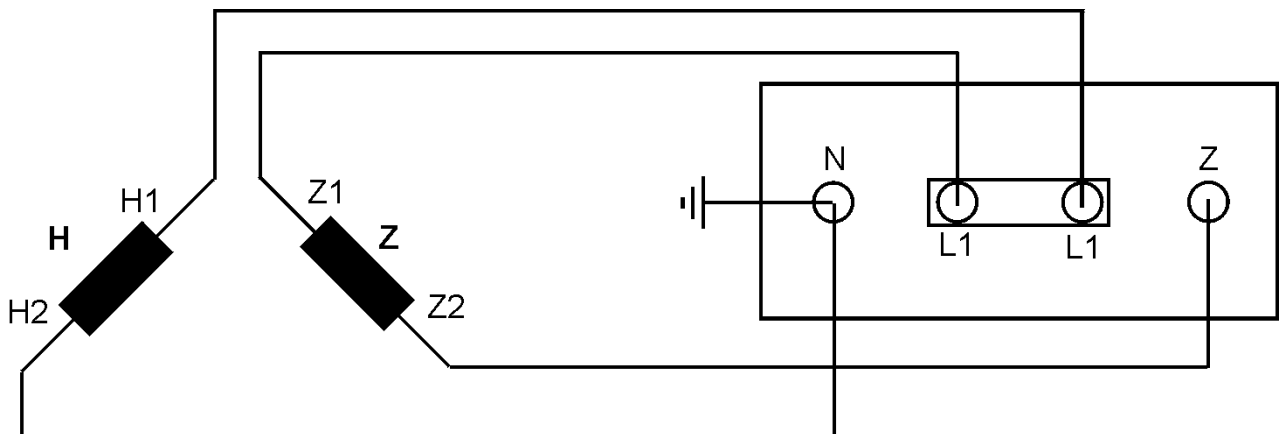


Fig. 8.5.0-2: Wiring diagram HP1 - 230 V / 50 Hz



### Generator Power Terminal Box 400 V / 50 Hz

In these terminal box there are the electrical connection points for the AC generator. Here is also the bridge for the protective grounding of the generator. The cover may only be removed, if it is guaranteed that the generator cannot be inadvertently started.

Sample Picture

Fig. 8.5.0-3: Generator Power Terminal Box 400 V / 50 Hz

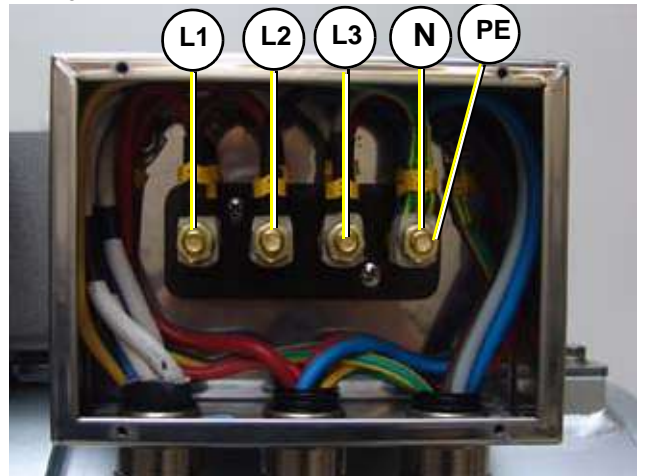
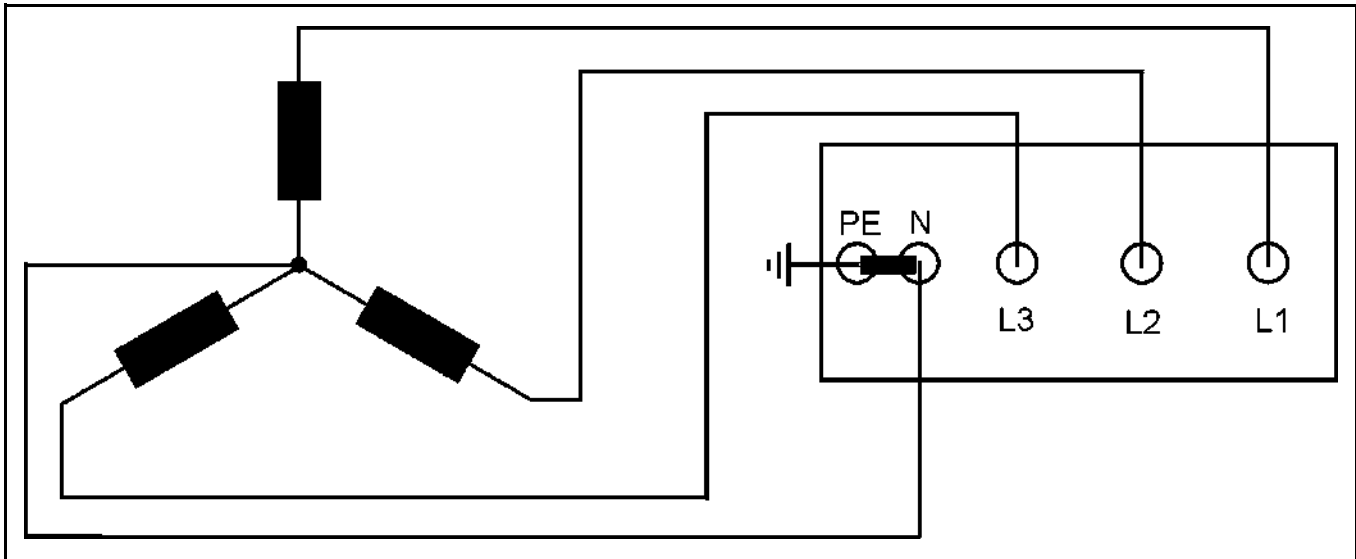


Fig. 8.5.0-4: Wiring diagram HP3 - 400 V / 50 Hz


**Generator Power Terminal Box 120 V / 60 Hz**

In these terminal box there are the electrical connection points for the AC generator. Here is also the bridge for the protective grounding of the generator. The cover may only be removed, if it is guaranteed that the generator cannot be inadvertently started.

*Sample Picture*

Fig. 8.5.0-5: Generator power terminal box 120 / 60 Hz

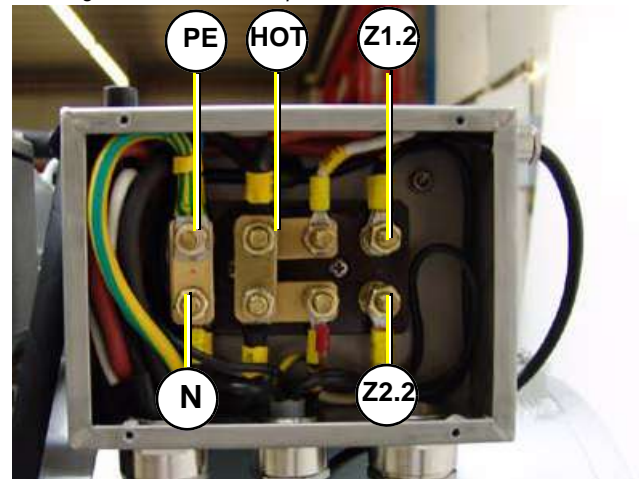
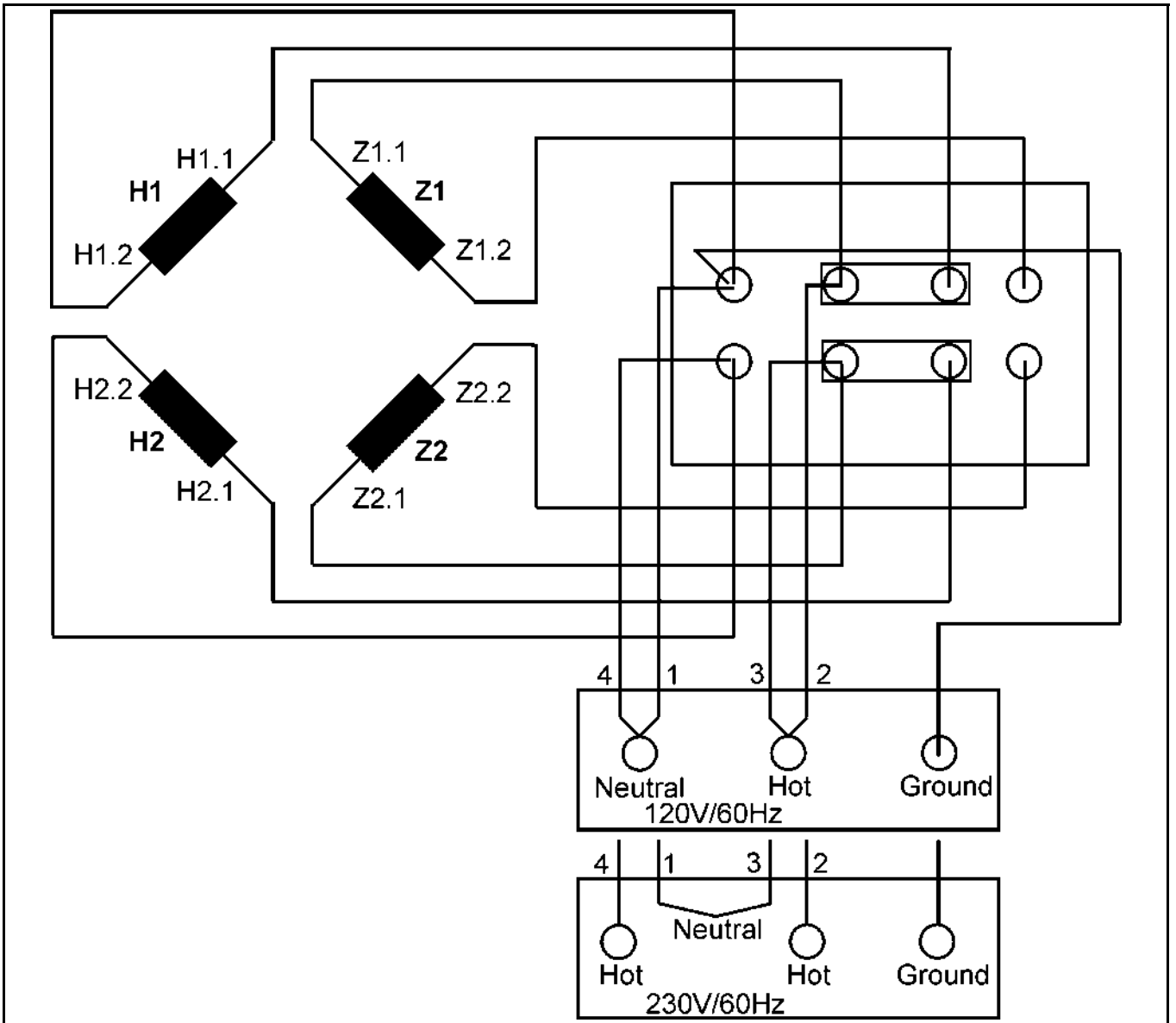


Fig. 8.5.0-6: Wiring diagram HP1 - 120 V / 60 Hz



**Generator Power Terminal Box 240 / 60 Hz (208 V / 60 Hz)**

In these terminal box there are the electrical connection points for the AC generator. Here is also the bridge for the protective grounding of the generator. The cover may only be removed, if it is guaranteed that the generator cannot be inadvertently started.

Sample Picture

Fig. 8.5.0-7: Generator power terminal box 240 V / 60 Hz

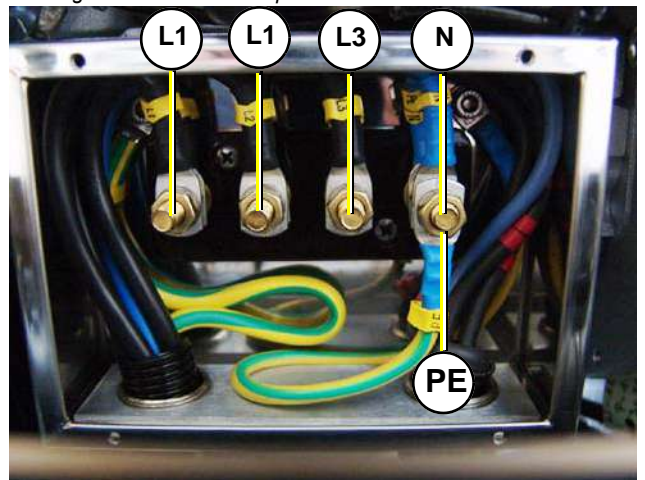
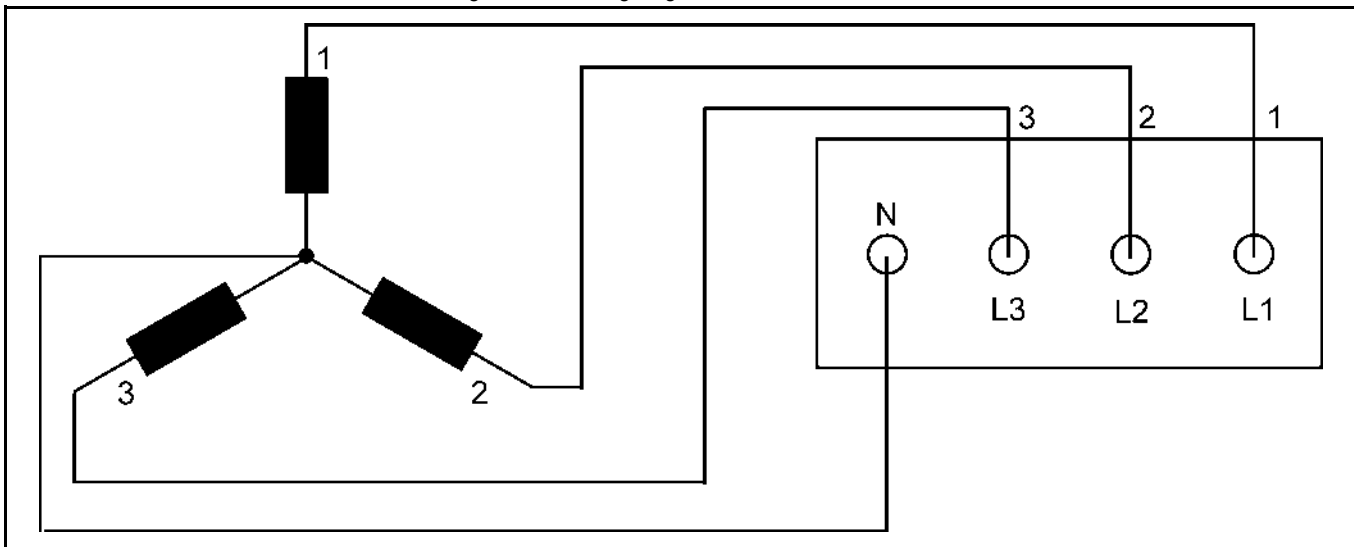




Fig. 8.5.0-8: Wiring diagram HP3 - 240 V / 60 Hz



### Generator Power Terminal Box DVS - 120 V + 240 V / 60 Hz

In these terminal box there are the electrical connection points for the AC generator. Here is also the bridge for the protective grounding of the generator. The cover may only be removed, if it is guaranteed that the generator cannot be inadvertently started.

Sample Picture

Fig. 8.5.0-9: Generator power terminal box DVS

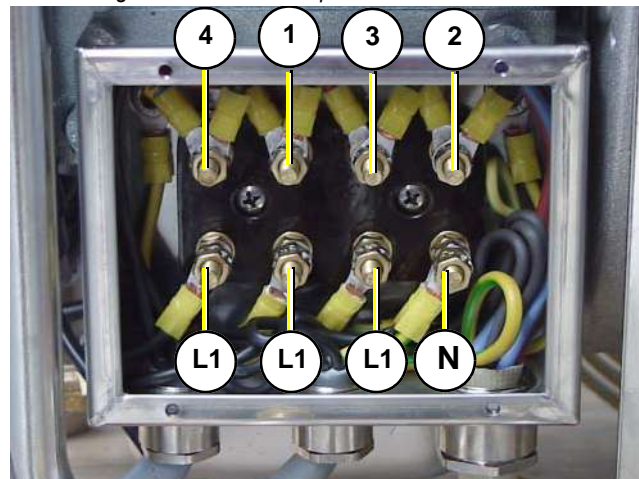


Fig. 8.5.0-10: Wiring diagram DVS - 120 V + 240 V / 60 Hz

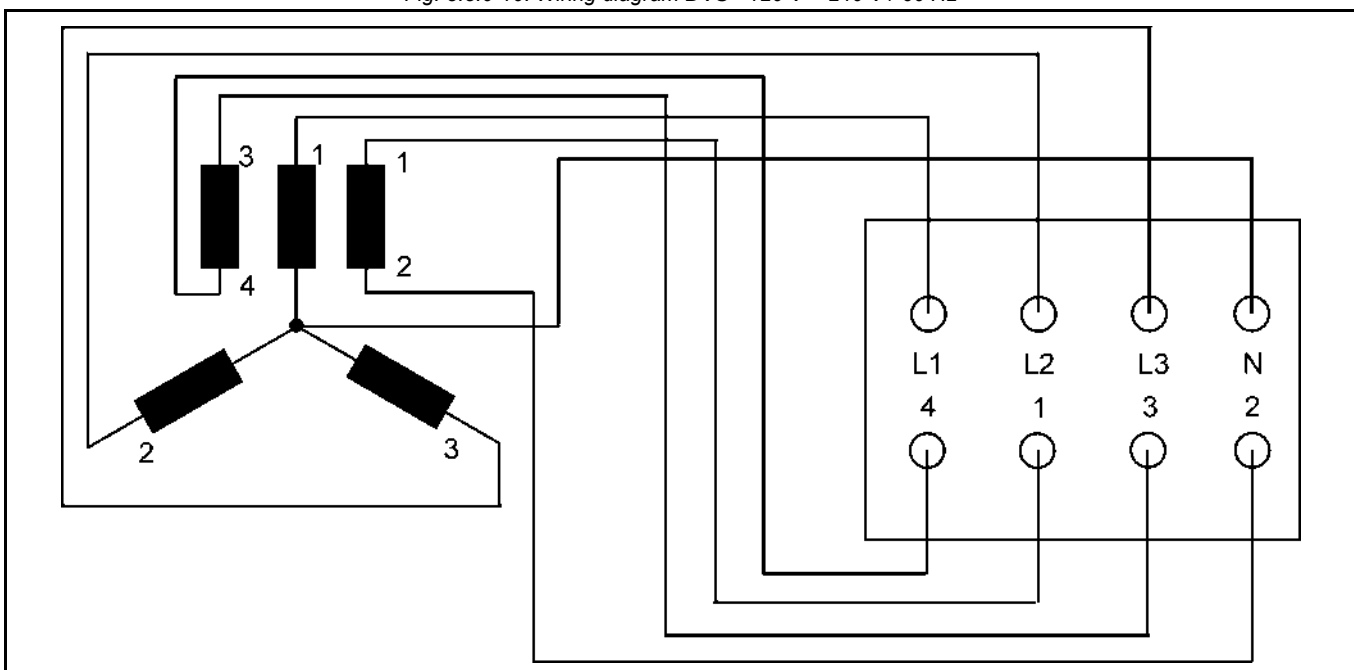
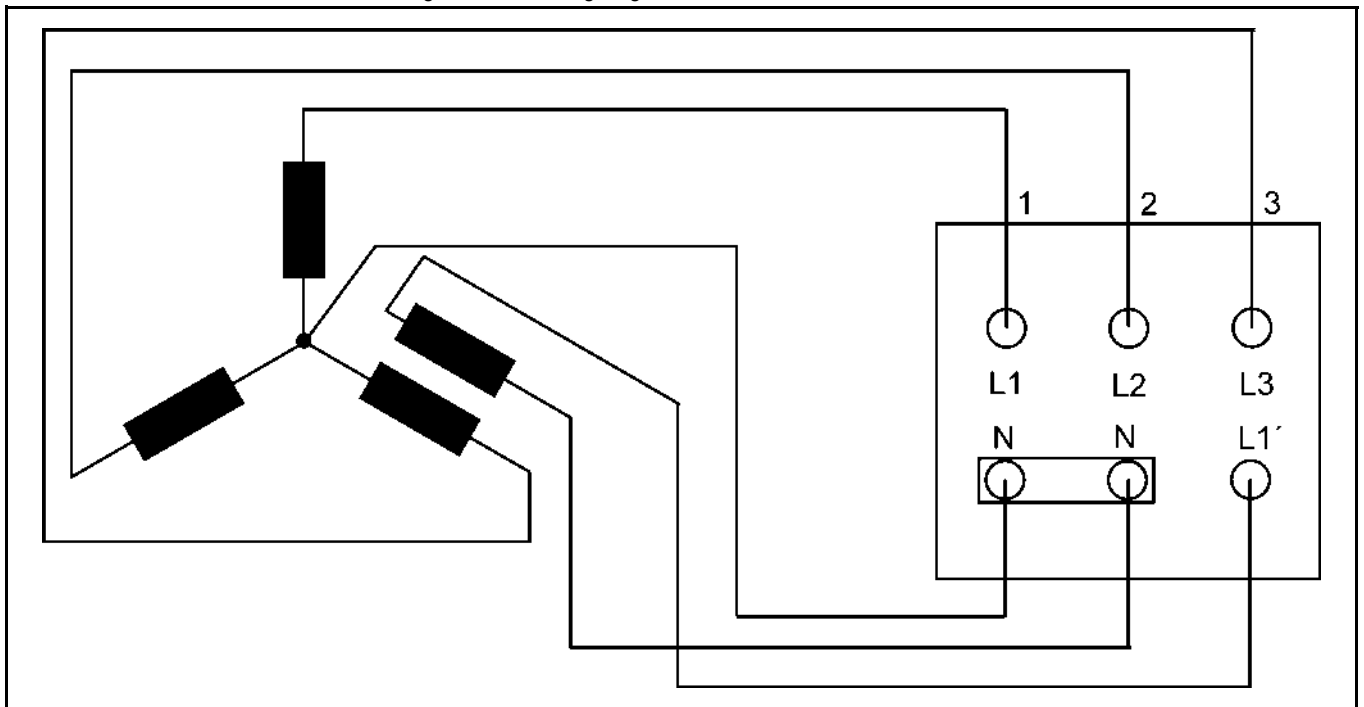




Fig. 8.5.0-11: Wiring diagram DVS - 230 V + 400 V / 50 Hz



## 8.6 Overloading the generator

Please ensure that the generator is not overloaded. This must be considered, especially with regards to multi power generators. In this case the extra load including the electrical performance can be considerably greater than the drive performance of the motor, which can eventually lead to a damaged motor.

The full nominal performance of the generator is fore-mostly for short term use. It is, however, required to start electric motors with high starting current or achieve special starting procedures at peak loads. 70% nominal load is ideal for a long motor life. (Continual use means uninterrupted use of the generator for many hours). This should be taken into consideration when connecting devices. This ensures extended motor life.

It is no problem for the motor to be run occasionally for 2 - 3 hours at full load. The complete conception of Panda Generator ensures that even during extreme conditions, an overheating of the motor will not occur. Accumulation of soot will occur if run for long periods at full load.

### Effects of Short Circulating and Overloading on the Generator

The generator cannot be damaged by short-circuit or overloading. Short-circuit and overloading suppress the magnetic excitation of the generator, thus, no current is generated and the voltage will collapse. This condition is immediately offset, once the short circuit has been eliminated and/or the electrical overload removed.

### Overloading the Generator with Electric Motors

With the operation of electric motors it must be considered that these take up a multiple of their rated output as starting current (six to tenfold).

If the power of the generator for the engine is not sufficient, the voltage in the generator breaks down after switching on the engine. For special approach problems the manufacturer can give recommendations regarding the accomplishment of the situation (e.g. amplified condensers, gradual start switch or extra developed starting unit for electric motors).

The system efficiency can be improved up to 50% and the starting current can be improved up to 100% by a professional adjustment of the engines. If the inductive load (electrical motors etc.) lies over 20% of the generator rated output compensation is appropriate (see in addition also the writing: „Operation Instructions for Generators with Inductive Loads“).

### 8.6.1 Monitoring the Generator Voltage

---

see “Safety first!” on Page 12.

**ATTENTION!**



The voltage range of the power stations normally lies between 200 and 240 V (100 - 130 V in the 60 Hz version). In some countries even substantially larger tension deviations are being called „normally“. The Fischer Panda generators are aligned that they keep these default values during normal load.

With high load or overload it can occur that the voltage drops on 190 V (95 V in the 60 Hz version) and partly still more deeply. That can become critical for certain devices (e.g. for electric motors, cooling compressors and possibly for electronic devices). It must be paid attention that the voltage for such consumers are sufficient. This can be supervised by a voltmeter.

The voltmeter should be always installed behind the change over switch generator/land power, so that each voltage source is shown. No further voltmeter is provided for the generator itself.

If additional consumers are switched on, the voltage must be controlled in each case at the voltmeter. Sensitive devices must be switched off so long, until the voltage exceed the critical parameter.

Under certain circumstances the generator provides over voltage. This arises if the number of revolutions of the generator is increased. Changing the number of revolutions may be made only with a tachometer and/or a voltmeter.

If sensitive and/or valuable devices are used, which are to be protected against this risk, an automatic over voltage protection must be mounted (voltage control with disconnection).

### 8.6.2 Automatic voltage monitoring and auto-shut down

---

If air conditioning units (compressors) or other such valuable equipment is installed on-board, it is recommend that an automatic voltage monitoring unit be installed to protect this equipment from possible sharp voltage drops. The voltage monitoring system shuts down the entire system (and therefore all users) by means of a circuit breaker relay as soon as the voltage falls below a set value (the monitor will also shut down the on-board grid automatically when the generator is stopped). Such a relay with contactor can be obtained from the installation or as a complete unit from your Fischer Panda dealer.



## 8.7 Generator-Output Voltage is too low

If the AC generated is too low, then the consumers should be disconnected, one after the other, in order to reduce the load on the generator. Generally the problem is then solved. The frequency should be checked, if the output voltage is correct after the consumers have been disconnected. Should this be above the prescribed generator idling speed, it can be assumed that one or several condensers are defective.

### 8.7.1 Discharging the Capacitors

**Never work on the control box, if the generator is running! Do not touch the capacitors contacts, see "Safety first!" on Page 12.**

**ATTENTION!**



Fig. 8.7.1-1: Capacitors

#### Capacitors

1. Switch off the generator.
2. Remove the starter battery.
3. Open the AC-Control Box.

**The capacitors are discharged by short fusing both contacts. The contacts (Flat plug) can be bridged by means of a screwdriver with an insulated handle (short-circuit).**



## 8.7.2 Checking the Capacitors

If the capacitors are to be checked, make sure that the capacitors has been discharged.

**ATTENTION!**



A visual check can give information on whether the capacitors are defective:

- Dielectric leak?
- Did the capacitor become longer?

### Multimeter

The capacitors can be tested by means of a multi-meter, which is fitted with a buzzer. The multi-meter should be switched to open and both capacitor connections connected to the multi-meter.

The capacitors can be tested with a multi-meter. Switch the measuring instrument to „pass“ and connect both connections of the capacitors to the connections at the measuring instrument.

Touch the two contacts of the capacitors by means of the test prods. A charge should be fed to the capacitor by the internal battery.

Fig. 8.7.2-1: Multimeter



Should a steady sound or no sound be heard, the capacitors are defective and must be replaced.

A capacity measuring instrument must be used in order to check whether the capacitors have full capacity.

The capacitors, which do meet the prescribed capacity value at this measurement, should be exchanged as fast as possible. If all capacitors prove to be still functional, then a check must be made, as to whether the connections to the strip are correct.

### 8.7.2.1 Checking the electrical connections to the capacitors

It must be ensured that the electrical connections to the capacitors are always tight fitting. Loose connections with transitional resistance can mean that the contact surfaces will become heated externally. This can lead to an increased deterioration of the capacitors.

## 8.7.3 Check the Generator Voltage

**The following steps must be taken, in order to test whether the stator winding generates sufficient voltage:**

1. The following steps must be taken, in order to test whether the stator winding generates sufficient voltage:
2. Ensure that the connection to the shipboard circuit is interrupted.
3. Remove all electrical wires in the generator junction box.
4. Starter battery must be connected to the generator.
5. Start generator.
6. Measure the voltage between the phases and neutral. It can be assumed that damage has been caused to the windings, if the measured values are below the values given in Table 9.9 on Page 206

Both partial windings must be connected for the 60Hz Version, i.e. there must be a connection made between wire 1 and 3 (see circuit plan).

(Note: The current arises from the rest magnetism of the rotor, which induces a voltage in the winding).

### 8.7.4 Measuring the Ohm Resistance of the Generator Windings

If a short circuit could not be found by using a multi-meter, then the windings parts of the generator must be checked by means of an Ohmmeter that is suitable for low resistance values.

- Set the measuring device to measure resistance. If you hold the poles of the measuring device against each other, then 0.00 Ohms should be shown. If the pole has been isolated then the display should show an overflow. Please carry out this test to check the device.
- Measure the resistance within the individual windings.

If there are large deviations, it must be assumed that there is a windings short circuit. This also leads to non-excitation of the generator.

The actual values between the windings parts and the earth cannot, however, be exactly determined. Fore-mostly, the values of all three measurements must be the same, if possible. Deviations from each other show there is windings short-circuit. In this case, the generator windings must be renewed by an electrician.

### 8.7.5 Check the Windings for Short circuit

Ensure that the generator has been switched off and cannot be inadvertently switched on. Disconnect the wires to the battery for this.

1. All wires in the junction box or - if necessary - in the circuit distribution box must be disconnected. Ensure that the wires are no longer carrying an electrical current, before being disconnected (see "Discharging the Capacitors" on Page 187.)
2. Remove the Bridges between „N“ and „PE“, so that the windings and casing do not come into electrical contact.
3. Make a check, by means of a Multimeter, as to whether there is a current between the individual winding terminals and the casing (PE).

The contacts to measured are not relevant to the type of generator (see type plate):

HP1 - 50 Hz: L, Z

HP1 - 60 Hz: L, Z

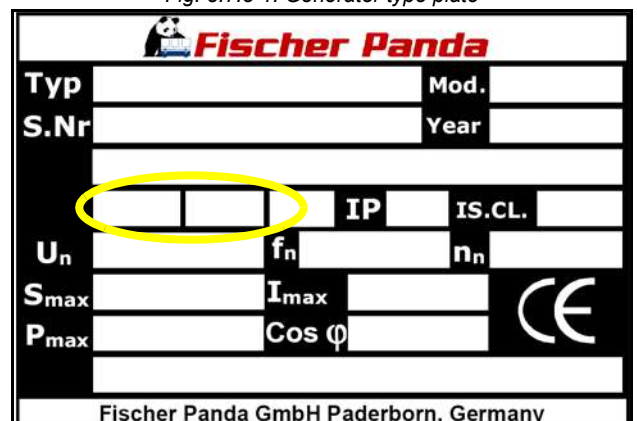
HP3 - 50 Hz: L1, L2, L3

HP3 - 60 Hz: L1, L2, L3, 1, 2, 3, 4

DVS - 50 Hz: L1, L2, L3, L1'

DVS - 60 Hz: L1, L2, L3, L1', 1, 2, 3, 4

Fig. 8.7.5-1: Generator type plate



Fischer Panda	
Typ	Mod.
S.Nr	Year
U <sub>n</sub>	f <sub>n</sub> n <sub>n</sub>
S <sub>max</sub>	I <sub>max</sub>
P <sub>max</sub>	Cos φ
IP	IS.CL.
Fischer Panda GmbH Paderborn, Germany	

The generator must be sent for a check to the factory or be re-winded locally, when a pass (beep) should be determined. Windings data can be requested for this, if it is necessary.

### 8.7.6 Measuring the Inductive Resistance

---

An Ohm measurement of a winding does not always give reliable information concerning the state of the winding. If there are resistance irregularities between the windings parts, this is a sure sign that the winding is defective. This means the opposite cannot be concluded. This means a winding can also be defective, if the resistance values between the windings parts do not show great deviation.

Measurement of the inductive resistance gives a better reading. A Special measuring device is necessary for this.

The inductively is measured in the same manner as the resistance, i.e. the windings parts are compared. The value of the inductive resistance is given in mH (milli Henry).

The correct values for the inductive resistance can be obtained from Table 9.8 on Page 205.

Note: The values are greatly dependent upon the measuring method (type of ohmmeter).

## 8.8 Generator provides no voltage

---

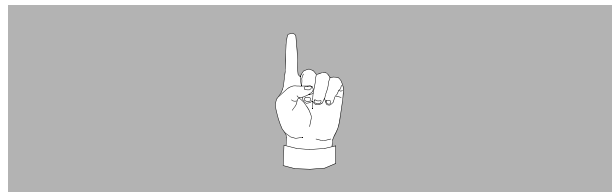
---

### 8.8.1 Rotor Magnetism Loss and „Re-magnetising“

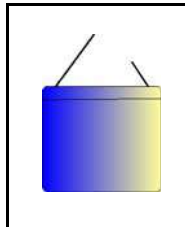
---

See “Safety Instructions - Safety First!” on Page 19.

**ATTENTION!**



In the case of asynchronous generators, the generator cannot independently increase voltage after standing still, or, if it is switched off under full load. This is because the rotor has lost its remaining magnetism.



This remaining magnetism can be restored simply by use of a DC battery. In addition the „shore power“ must be switched off and any connection to an AC-source must be interrupted.

Likewise the generator must be switched off, i.e. also the starter may not be operated. The power source selector is switched to „generator“. Only the plug socket must be connected with the generator.

Now the two poles of a 9 Volt battery are connected to the plug socket or held against the appropriate contacts of the on-board current distributor. Do not use a battery bank or the generator starter battery, this could damage the winding. The DC voltage only may be applied for a short time (1-2 seconds). In the winding the remaining magnetism is restored by a short current pulse, and the generator can normally be started.

## 8.9 Engine Starting Problems

### 8.9.1 Electric Fuel Solenoid Valve

The fuel solenoid valve is located in front of the injection pump. It opens automatically, if the „START“-button is pressed on remote control panel. If the generator is switched to „OFF“, the solenoid valve closes. It takes some seconds, before the generator stops.

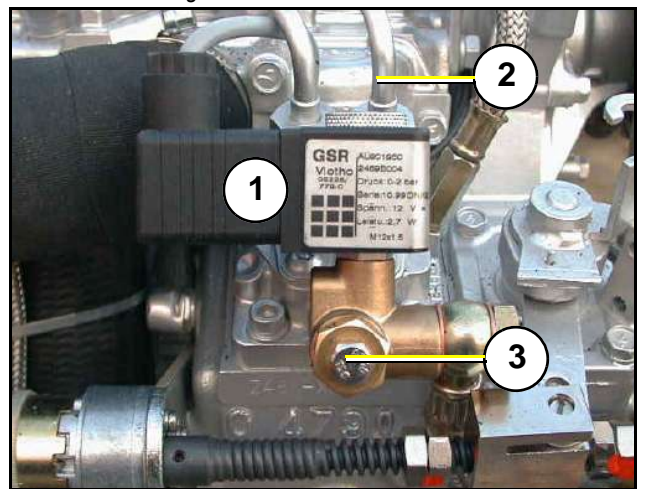
If the generator fails to start, runs rough, does not reach the proper RPM, or does not stop properly, the first item to suspect in most cases it is the fuel solenoid valve and should be inspected first.

A check of the fuel solenoid valve by removing the plug from the fuel solenoid valve for a short period whilst in operation (first remove the small retention screw) and replace it immediately. The motor should „react immediately“ by revving high. If the motor does not react sharply to the re-connection of the solenoid wire, it is a sign that the solenoid valve could be faulty.

1. Fuel solenoid valve
2. Fuel injector
3. Ventilation screw

*Sample Picture*

Fig. 8.9.1-1: Fuel Solenoid Valve



### 8.9.2 Re-start with Failure Bypass Switch

The start-failure bypass switch enables an immediate restart facility of the generator, should it cut out, even if this was caused by over-heating. There is normally a requirement to wait until the motor has cooled down to the correct temperature. This can last for several hours in certain circumstances, since the generator is enclosed in a sound-insulated casing, which prevents heat loss.

#### Failure Bypass Switch

*Sample Picture*

Fig. 8.9.2-1: Failure Bypass Switch



This period can be reduced by pushing the button on the front of the generator. The generator can be started by means of the remote control as long as the button is depressed. The switch/ button bypasses any faults allowing the generator to run.

Before depressing the button, check the oil level with the dip stick to determine whether the generator has sufficient oil, as it is possible that the oil pressure switch causes the generator to cut out. If it has been ascertained that the reason for the motor cutting out is overheating and not lack of oil, the generator can be run for several minutes without load, so that the motor is cooled by the circulating coolant.

**BEWARE:**

**If the temperature is the reason for the generator cutting out when it is running under load, then an immediate check must be made to determine the cause. It could be a fault with the cooling system, one of the fans, the air-intake or a fault with the external cooling system.**

Continual use of the starter-failure bypass switch should be avoided, while the generator cuts out during operation.

The generator must always run without load for several minutes before being switched off, so that temperature compensation occurs. Heat accumulation can cause the generator to overheat, even after it has been switched off.

Should the overheating alarm be set off, caused by heat accumulation, after the generator has been switched off, then this can also be bypassed using the switch.

### 8.9.3 Lifting solenoid for motor stop - optional

There are two different versions of lifting solenoids:

**A. Energized to stop**

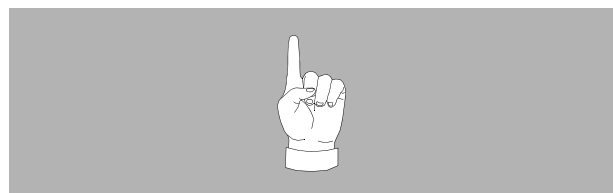
The lifting solenoid is furnished with voltage and pulled by pushing the „OFF“-button on the remote control panel. By doing that, the injection pump is set on zero lift and the generator stops.

**B. Energized to run**

This version is equipped with two solenoids, an operation- and a holding solenoid. After applying voltage, the operation solenoid pulls the adjusting lever of the injection pump, which gives way to the fuel. After reaching its end position, the operation magnet is switched off and the holding solenoid keeps that position as long as the generator is operating.

**The „START“-button should not be pressed any longer than 5 sec. during the starting process, or the lifting solenoid draws too much current over the starter motor. Otherwise the lifting solenoid needs to be disconnected.**

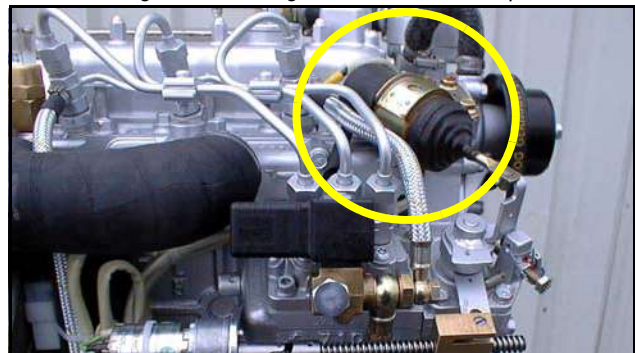
**ATTENTION!**



**Lifting solenoid for motor stop**

*Sample Picture*

*Fig. 8.9.3-1: Lifting solenoid for motor stop*



**Damage to starter motor**

The starter is fitted with a free wheel or axial rotating spring cog, which prevents the starter being driven externally by means of the motor. The free wheel will be heavily worn, if the starter still operates, thereby causing damage to



the springs, roller bearings or cog teeth. This could lead to complete destruction of the starter.

**It is important that every person who operates the generator is informed of this situation. This is practically the only handling error that can be made on board that can lead to fatal consequences for both generator and operator.**

### 8.9.4 Troubleshooting Table

---

For Troubleshooting see “Troubleshooting Table and Flowchart” on Page 172.



## 9. Tables

### 9.1 Technical Data

Fig. 9.1-1: Technical Data

	Panda 4000s	Panda 4200 FCB	4500FCB		
Type	Farymann 18W430	Farymann 18W430	Farymann 18W430		
Governor	mechanic	mechanic	mechanic		
Automatic start booster	yes	yes	yes		
Cylinder	1	1	1		
Bore	82 mm	82 mm	82 mm		
Stroke	55 mm	55 mm	55 mm		
Stroke volume	290 cm <sup>3</sup>	290 cm <sup>3</sup>	290 cm <sup>3</sup>		
Max. power (DIN 6271-NB) at 3000rpm	5,7 kW	5,7 kW	5,7 kW		
Rated speed	3600 rpm	3600 rpm	3600 rpm		
Idle running speed <sup>2</sup>	3690 rpm	3690 rpm	3690 rpm		
Valve clearance (engine cold)	0,2 mm	0,2 mm	0,2 mm		
Cylinder head nut torque	30-33 Nm	30-33 Nm	30-33 Nm		
Compression ratio	20:1	20:1	20:1		
Lubrication oil capacity	1,25 l	1,25 l	1,25 l		
Fuel consumption <sup>3</sup>	approx 0,42- 1,12 l	approx. 0,42- 1,12 l	approx. 0,42- 1,12 l		
Oil consumption	max. 1% of fuel consumption				
Oil specification	API CF	API CF	API CF		
Cooling water requirement for seawater circuit (Marine generators only)	10-12 l/min	10-12 l/min	16-28l/min		
Permissible max. permanent tilt of engine	a) 25° across the longitudinal axis b) 20° in the longitudinal direction				
Recommend starter battery size	12V 28Ah equivalent	12V 28Ah equivalent	12V 36Ah equivalent		
Recommend cable cross size starter battery cable <i>Length 4 meter max.</i>	25mm <sup>2</sup>	25mm <sup>2</sup>	25mm <sup>2</sup>		
Max. exhaust back pressure	9,3 kPa 93 Millibar	9,3 kPa 93 Millibar <sup>2</sup>	9,3 kPa 93 Millibar		

<sup>2</sup> progressive speed by VCS

<sup>3</sup> 0,35l/kW electrical power, the randomized values between 30% and 80% of the rated speed

Fig. 9.1-2: Technical Data

	Panda 6500 Panda 7 mini	Panda 8000 NE Panda 8 mini	Panda 9000 ND	Panda 10000 NE Panda 9 mini	Panda 12000 NE
Type	Z482	Z482	D722	Z602	D722
Governor	MInI VCS	VCS	mechanic	VCS	VCS
Automatic start booster	no	yes	no	yes	yes
Cylinder	2	2	3	2	3
Bore	67 mm	67 mm	67 mm	72 mm	67 mm
Stroke	68 mm	68 mm	68 mm	73,6 mm	68 mm
Stroke volume	479 cm <sup>3</sup>	479 cm <sup>3</sup>	719 cm <sup>3</sup>	599 cm <sup>3</sup>	719 cm <sup>3</sup>
Max. power (DIN 6271-NB) at 3000rpm	9,32kW	9,32 kW	14,0 kW	11,6 kW	14,0 kW
Rated speed	3000 rpm	3000 rpm	3000 rpm	3000 rpm	3000 rpm

	Panda 6500 Panda 7 mini	Panda 8000 NE Panda 8 mini	Panda 9000 ND	Panda 10000 NE Panda 9 mini	Panda 12000 NE
Idle running speed <sup>2</sup>	3120 rpm	2900 rpm	3120 rpm	3100 rpm	2900 rpm
Valve clearance (engine cold)	0,2 mm	0,2 mm	0,2 mm	0,2 mm	0,2 mm
Cylinder head nut torque	42 Nm	42 Nm	42 Nm	42 Nm	42 Nm
Compression ratio	23:1	23:1	23:1	24:1	23:1
Lubrication oil capacity	2,8 l	2,8 l	3,8 l	2,8 l	3,8 l
Fuel consumption <sup>3</sup>	approx. 0,5-1,4l	approx. 0,7-1,8l	approx. 0,8-2,1l	approx. 1,0-2,66l	approx. 1,1-2,8l
Oil consumption	max. 1% of fuel consumption				
Oil specification	API CF	API CF	API CF	API CF	API CF
Cooling water requirement for seawater circuit (Marine generators only)	16-28l/min	16-28l/min	16-28l/min	16-28l/min	16-28l/min
Permissible max. permanent tilt of engine	a) 25° across the longitudinal axis b) 20° in the longitudinal direction				
Recommend starter battery size	12V 28Ah equivalent	12V 28Ah equivalent	12V 36Ah equivalent	12V 36Ah equivalent	12V 36Ah equivalent
Recommend cable cross size starter battery cable <i>Length 4 meter max.</i>	25mm <sup>2</sup>	25mm <sup>2</sup>	25mm <sup>2</sup>	25mm <sup>2</sup>	25mm <sup>2</sup>
Max. exhaust back pressure	9,3 kPa 93 Millibar	9,3 kPa 93 Millibar <sup>2</sup>	9,3 kPa 93 Millibar	9,3 kPa 93 Millibar	9,3 kPa 93 Millibar

<sup>2</sup> progressive speed by VCS

<sup>3</sup> 0,35l/kW electrical power, the randomized values between 30% and 80% of the rated speed

Fig. 9.1-3: Technical Data

	Panda 14000 NE	Panda 15000 NE	Panda 18 NE	Panda 24 NE	Panda 30 NE
Type	D782	D902	D1105	V1505	V1505 TD
Governor	VCS	VCS	VCS	VCS	VCS
Automatic start booster	yes	yes	yes	no	no
Cylinder	3	3	3	4	4TD
Bore	67 mm	72 mm	78 mm	78 mm	78 mm
Stroke	73,6 mm	73,6 mm	78,4 mm	78,4 mm	78,4 mm
Stroke volume	782 cm <sup>3</sup>	898 cm <sup>3</sup>	1123 cm <sup>3</sup>	1498 cm <sup>3</sup>	1498 cm <sup>3</sup>
Max. power (DIN 6271-NB) at 3000rpm	13,5 kW	17,5 kW	18,7 kW	23,3 kW	31,3 kW
Rated speed	3000 rpm	3000 rpm	3000 rpm	3000 rpm	3000 rpm
Idle running speed <sup>2</sup>	2900 rpm	2900 rpm	2900 rpm	2900 rpm	2900 rpm
Valve clearance (engine cold)	0,2 mm	0,2 mm	0,2 mm	0,2 mm	0,2 mm
Cylinder head nut torque	68 Nm	42 mm	68 Nm	68 Nm	68 Nm
Compression ratio	23:1	24:1	22:1	22:1	23:1
Lubrication oil capacity	3,8 l	3,7 l	5,1 l	6,0 l	6,7 l
Fuel consumption <sup>3</sup>	approx. 1,3-3,4l	approx. 1,3-3,6l	approx. 1,7-4,5l	approx. 2,2-5,9	approx. 2,7-7,2l
Oil consumption	max. 1% of fuel consumption				
Oil specification	API CF	API CF	API CF	API CF	API CF
Cooling water requirement for seawater circuit (Marine generators only)	16-28l/min	6-28l/min	28-40l/min	28-40l/min	40-50l/min
Permissible max. permanent tilt of engine	a) 25° crosswise to the longitudinal axis b) 20° in longitudinal direction				
Recommend starter battery size	12V 36Ah equivalent	12V 52Ah equivalent	12V 65Ah equivalent	12V 70Ah equivalent	12V 70Ah equivalent
Recommend cable cross size starter battery cable <i>Length 4 meter max.</i>	25mm <sup>2</sup>	25mm <sup>2</sup>	25mm <sup>2</sup>	25mm <sup>2</sup>	25mm <sup>2</sup>
Max. exhaust back pressure	9,3 kPa 93 Millibar	9,3 kPa 93 Millibar <sup>2</sup>	10,7 kPa 107 Millibar	10,7 kPa 107 Millibar	10,7 kPa 107 Millibar

<sup>2</sup> progressive speed by VCS

<sup>3</sup> 0,35l/kW electrical power, the randomized values between 30% and 80% of the rated speed

Fig. 9.1-4: Technical data

	Panda 30 IC PMS	Panda 40 LN	Panda 47 LN	Panda 60 MB PVM-NE	Panda 75 MB PVM-NE
<b>Type</b>	Kubota V 1505 TB	LDW 2204 MT	LDW 2204T	Mercedes Benz OM602	Mercedes OM603A
<b>Governor</b>	VCS	VCS	VCS	mechanical + VCS	mechanical + VCS
<b>Automatic start booster</b>	yes	no	no	no	no
<b>Cylinder</b>	4	4	4	5	6
<b>Bore</b>	78 mm	88 mm	88 mm	89 mm	89 mm
<b>Stroke</b>	78,4 mm	90,4 mm	90,4 mm	92,4 mm	92,4 mm
<b>Stroke volume</b>	1498 cm <sup>3</sup>	2199 cm <sup>3</sup>	2199 cm <sup>3</sup>	2874 cm <sup>3</sup>	3500 cm <sup>3</sup>
<b>Max. power (DIN 6271-NB) at 3000rpm</b>	31,3 kW	36 kW	36 kW	69 kW	69 kW
<b>Rated speed</b>	3000 rpm	3000 rpm	3000 rpm	4000 rpm	3000 rpm
<b>Idle running speed <sup>2</sup></b>	2900 rpm	3000 rpm	3000 rpm		2900 rpm
<b>Valve clearance (engine cold)</b>	0,2 mm	Hydro	Hydro		0,2 mm
<b>Cylinder head nut torque</b>	63,7 - 68,6 Nm	68 Nm	68 Nm		25 Nm
<b>Compression ratio</b>	22,5:1	22:16	22:16		22:1
<b>Lubrication oil capacity</b>	5,0 l	6,4 l	6,4 l	7,5 l	7,5l
<b>Fuel consumption <sup>3</sup></b>	approx. 2,7 - 7,1l	approx. 4,9-13,1l	approx. 3,78-10,1l	approx. 6,3 - 16,8 l	approx. 6,7 - 17,9l
<b>Oil consumption</b>	max. 1% of fuel consumption			max. 0,5% of fuel consumption	
<b>Oil specification</b>	API CF	API CF	API CF-4	API CF	API CF
<b>Cooling water requirement for seawater circuit (Marine generators only)</b>	40-50l/min	40-50l/min	40-50l/min		
<b>Permissible max. permanent tilt of engine</b>	a) 25° crosswise to the longitudinal axis b) 20° in longitudinal direction				
<b>Recommend starter battery size</b>	12V 70Ah equivalent	12V 88 Ah equivalent	12V 88 Ah equivalent	12V 95 Ah equivalent	12V 95 Ah equivalent
<b>Recommend cable cross size starter battery cable</b> <i>Length 4 meter max.</i>	25mm <sup>2</sup>	50mm <sup>2</sup>	50mm <sup>2</sup>	70mm <sup>2</sup>	70mm <sup>2</sup>
<b>Max. exhaust back pressure</b>	10,7 kPa 107 Millibar	10 kPa 100 Millibar	10kPa 100 Millibar		

<sup>2</sup> progressive speed by VCS

<sup>3</sup> 0,35l/kW electrical power, the randomized values between 30% and 80% of the rated speed

Fig. 9.1-5: Technical data

	Panda 7,5-4	Panda 9-4	Panda 12-4	Panda 17-4	Panda 22-4
<b>Type</b>	Kubota D905	Kubota D1105	Kubota V1505	Kubota V2203	Kubota V2403
<b>Governor</b>	mechanical + VCS	VCS	VCS	VCS	VCS
<b>Automatic start booster</b>	no	no	no	no	no
<b>Cylinder</b>	3	3	4	4	4
<b>Bore</b>	72 mm	78 mm	78mm	87	87 mm
<b>Stroke</b>	73,6 mm	78,4 mm	78,4mm	92,4	102,4 mm
<b>Stroke volume</b>	898 ccm	1123 ccm	1498cm <sup>3</sup>	2197	2434 ccm
<b>Max. power (DIN 6271-NB) at 3000rpm</b>	17,5 kW	18,7 kW	23,3kW	20,1 KW	31,1 kW
<b>Rated speed</b>	1500 rpm	1500 rpm	1500 rpm	1500 rpm	1500 rpm
<b>Idle running speed <sup>2</sup></b>	1500 rpm	1500 rpm	1800 rpm	1500 rpm	1800 rpm
<b>Valve clearance (engine cold)</b>	0,145 - 0,185 mm	0,145 - 0,185 mm	0,2mm	0,2mm	0,18 - 0,22 mm
<b>Cylinder head nut torque</b>	63,7 - 68,6 Nm	63,7 - 68,6 Nm	68Nm	68Nm	93,1 - 98 Nm
<b>Compression ratio</b>	23:1	23:1	22:1	22:1	

	Panda 7,5-4	Panda 9-4	Panda 12-4	Panda 17-4	Panda 22-4
Lubrication oil capacity	5,1 l	5,1 l	6,0l	9,5	9,5 l
Fuel consumption <sup>3</sup>	0,7 - 1,8 l	0,84 - 2,24 l	ca. 1,20-3,36 l	ca. 1,8-4,9 l	approx. 1,95 - 5,2
Oil consumption	max. 1% of fuel consumption				
Oil specification	API CF	API CF	API CF	API CF	API CF
Cooling water requirement for seawater circuit (Marine generators only)	6-28l/min	28-40l/min	28-40l/min	28-40l/min	40-50l/min
Permissible max. permanent tilt of engine	a) 25° crosswise to the longitudinal axis b) 20° in longitudinal direction				
Recommend starter battery size	12V 65Ah equivalent	12V 65Ah equivalent	12V 70Ah equivalent	12V 120Ah equivalent	12V 136Ah equivalent
Recommend cable cross size starter battery cable <i>Length 4 meter max.</i>	25mm <sup>2</sup>	25mm <sup>2</sup>	25mm <sup>2</sup>	70mm <sup>2</sup>	70mm <sup>2</sup>
Max. exhaust back pressure	10,7 kPa 107 Millibar	10,7 kPa 107 Millibar	10,7 kPa 107 Millibar	10,7 kPa 107 Millibar	10,7 kPa 107 Millibar

<sup>2</sup> progressive speed by VCS

<sup>3</sup> 0,35l/kW electrical power, the randomized values between 30% and 80% of the rated speed

Fig. 9.1-6: Technical Data

	Panda 30/4	Panda 30/4	Panda 40/4	Panda 50/4	Panda 70/4
Type	Mitsubishi S-DTS	V3600	V3600	V3800 DI-T	BF4M 1013EC
Governor	VCS	VCS	VCS	Mechanical + GAC	VCS
Automatic start booster	no	no	no	no	no
Cylinder	4	4	4	4	4
Bore	94	98 mm	98 mm	100 mm	108
Stroke	120	120 mm	120 mm	120 mm	130
Stroke volume	3331	3620 ccm	3620 ccm	3769 ccm	4764
Max. power (DIN 6271-NB) at 3000rpm		45,8 kW	58,8 kW	62,0 kW	85,0 kW
Rated speed	1500 rpm	1500 rpm	1500 rpm	1500 rpm	1500 rpm
Idle running speed <sup>2</sup>	1500 rpm	1800 rpm	2800 rpm	1800 rpm	1800 rpm
Valve clearance (engine cold)	0,25mm	0,2 mm	0,2 mm	0,2 mm	Inlet 0,3 + 0,1 / Outlet 0,5 + 0,1
Cylinder head nut torque	118	68 Nm	68 Nm	68 Nm	
Compression ratio	20.5:1	22,6:1	22,6:1	19,0:1	17,6:1
Lubrication oil capacity	10,0	13,2 l	13,2 l	13,2 l	14,0 l
Fuel consumption <sup>3</sup>	approx. 3,15-8,4 l	approx. 3,15-8,4 l	approx. 3,78-10,1 l	approx. 4,2-11,2 l	approx. 6,5-17,3 l
Oil consumption					
Oil specification	API CF4 (SAE30)	API CF	API CF	API CF	API CF
Cooling water requirement for seawater circuit (Marine generators only)	40-50l/min	40-50l/min	40-50l/min	40-50l/min	
Permissible max. permanent tilt of engine					
Recommend starter battery size	12V 136Ah equivalent	12V 136Ah equivalent	12V 136Ah equivalent	12V 136Ah equivalent	
Recommend cable cross size starter battery cable <i>Length 4 meter max.</i>	70mm <sup>2</sup>	70mm <sup>2</sup>	70mm <sup>2</sup>	70mm <sup>2</sup>	
Max. exhaust back pressure	4 kPa 40 Millibar	10,7 kPa 107 Millibar	10,7 kPa 107 Millibar	10,7 kPa 107 Millibar	

<sup>2</sup> progressive speed by VCS

<sup>3</sup> 0,35l/kW electrical power, the randomized values between 30% and 80% of the rated speed

Fig. 9.1-7: Technical Data igenerators

	Panda 5000i	Panda 8000i	Panda 10000i	Panda 15000i	Panda 25i
Type	EA300	Z482	Z602	D902	Kubota V1505
Governor	iControl2	iControl2	iControl2	iControl2	iControl2
Automatic start booster	no	no	no	no	no
Cylinder	1	2	2	3	4
Bore	75mm	67mm	72 mm	72mm	78mm
Stroke	70mm	68mm	73,6 mm	73,6mm	78,4mm
Stroke volume	309cm <sup>3</sup>	479cm <sup>3</sup>	599cm <sup>3</sup>	898cm <sup>3</sup>	1498cm <sup>3</sup>
Max. power (DIN 6271-NB) at 3000rpm	5,1kW	9,32kW	11,6kW	17,5kW	23,3kW
Rated speed	3000rpm	3000rpm	3000rpm	3000UpM	1500 rpm
Idle running speed	2900rpm	2900rpm	3100rpm	2900UpM	1800 rpm
Valve clearance (engine cold)	0,16 - 0,20mm	0,2mm	0,2mm	0,2mm	0,2mm
Cylinder head nut torque	58,8 - 63,7Nm	42Nm	42Nm	42mm	68Nm
Compression ratio	--	23:1	24:1	24:1	22:1
Lubrication oil capacity	1,3l	2,8l	2,8l	3,7l	6,0l
Fuel consumption <sup>3</sup>	approx. 0,42 - 1,12l	approx. 0,7-1,8l	approx. 1,0-2,66l	approx. 1,3-3,6l	approx. 1,20-3,36l
Oil consumption	max. 1% of fuel consumption				
Oil specification	API CF	API CF	API CF	API CF	API CF
Cooling water requirement for seawater circuit (Marine generators only)	--	16-28l/min	16-28l/min	16-28l/min	28-40l/min
Permissible max. permanent tilt of engine	a) 25° crosswise to the longitudinal axis b) 20° in longitudinal direction				
Recommend starter battery size	12V 28Ah equivalent	12V 28Ah equivalent	12V 36Ah equivalent	12V 52Ah equivalent	12V 70Ah equivalent
Recommend cable cross size starter battery cable Length 4 meter max.	25mm <sup>2</sup>	25mm <sup>2</sup>	25mm <sup>2</sup>	25mm <sup>2</sup>	25mm <sup>2</sup>
Max. exhaust back pressure	--	9,3 kPa 93 Millibar <sup>2</sup>	9,3 kPa 93 Millibar	9,3 kPa 93 Millibar <sup>2</sup>	10,7 kPa 107 Millibar

<sup>3</sup> 0,35l/kW electrical power, the randomized values between 30% and 80% of the rated speed

Fig. 9.1-8: Technical Data igenerators

	Panda 45i			
Type	Kubota V2403			
Governor	VCS			
Automatic start booster	no			
Cylinder	4			
Bore	87 mm			
Stroke	102,4 mm			
Stroke volume	2434 ccm			
Max. power (DIN 6271-NB) at 3000rpm	31,1 kW			
Rated speed	2700 rpm			
Idle running speed	1600 rpm			
Valve clearance (engine cold)	0,18 - 0,22 mm			
Cylinder head nut torque	93,1 - 98 Nm			
Compression ratio				
Lubrication oil capacity	9,5 l			
Fuel consumption <sup>3</sup>	approx. 1,95 - 5,2l			
Oil consumption	max. 1% of fuel consumption			
Oil specification	API CF			

	Panda 45i				
Cooling water requirement for seawater circuit (Marine generators only)	55-80 l/min				
Permissible max. permanent tilt of engine	a) 25° crosswise to the longitudinal axis b) 20° in longitudinal direction				
Recommend starter battery size	12V 136Ah equivalent				
Recommend cable cross size starter battery cable <i>Length 4 meter max.</i>	70mm <sup>2</sup>				
Max. exhaust back pressure	10,7 kPa 107 Millibar				

<sup>3</sup> 0,35l/kW electrical power, the randomized values between 30% and 80% of the rated speed

## 9.2 Rated current

Fig. 9.2-1: Rated current

Panda 8000 - 230 V / 50 Hz	27,0 A		Panda 18 - 230 V / 50 Hz	60,3 A
Panda 8000 - 400 V / 50 Hz	8,3 A		Panda 18 - 400 V / 50 Hz	20,0 A
Panda 8000 - 120 V / 60 Hz	61,8 A		Panda 18 - 120 V / 60 Hz	128,0 A
Panda 9000 - 230 V / 50 Hz	34,9 A		Panda 24 - 230 V / 50 Hz	89,1 A
Panda 9000 - 400 V / 50 Hz	11,1 A		Panda 24 - 400 V / 50 Hz	30,1 A
Panda 9000 - 120 V / 60 Hz	74,5 A		Panda 24 - 120 V / 60 Hz	161,1 A
Panda 12000 - 230 V / 50 Hz	41,7 A		Panda 30 - 230 V / 50 Hz	Anfrage
Panda 12000 - 400 V / 50 Hz	13,7 A		Panda 30 - 400 V / 50 Hz	35 A
Panda 12000 - 120 V / 60 Hz	89,0 A		Panda 30 - 120 V / 60 Hz	219 A
Panda 14000 - 230 V / 50 Hz	48,0 A			
Panda 14000 - 400 V / 50 Hz	15,2 A			
Panda 14000 - 120 V / 60 Hz	112,7 A			

## 9.3 Cable cross section

Fig. 9.3.0-1: Cable cross section

length	1 - 3 m	4 - 6 m	7 - 10 m	11 - 15 m	16 - 20 m
16 mm <sup>2</sup>	70 A	63 A	55 A	48 A	42 A
25mm <sup>2</sup>	112 A	100 A	88 A	75 A	63 A
35mm <sup>2</sup>	145 A	130	110	100 A	90 A
50mm <sup>2</sup>	225 A	200 A	175 A	150 A	125 A
70mm <sup>2</sup>	275 A	250 A	225 A	195 A	170 A
95mm <sup>2</sup>	340 A	300 A	280 A	260 A	220 A

## 9.4 Fuel

Use a clean No. 2 Diesel fuel oil (SAE J313 JUN87) according to ASTM D975 and EN 590.

Do not use alternative fuel, because its quality is unknown or it may be inferior in quality. Kerosene, which is very low in cetane rating, adversely effects the engine.



## 9.5 Engine oil

### 9.5.1 Engine oil classification

#### 9.5.1.1 Operating range:

The operating range of an engine oil is determined by SAE class. „SAE“ is for the union of American auto engineers (Society of Automotives Engineers).

The SAE class of an engine oil only informs over the viscosity of the oil (larger number = more viscous, smaller number = more highly liquidly) e.g. to 0W, 10W, 15W, 20, 30, 40. The first number shows the liquid of the oil with cold weather, the second number refers to the fluidity with heat. Complete yearly oils have usually SAE classes of SAE 10W-40, SAE 15W-40 etc.

#### 9.5.1.2 Quality of oil:

The quality of an engine oil is specified by the API standard („American Petroleum Institutes“).

The API designation is to be found on each engine oil bundle. The first letter is always a C.

##### API C for diesel engines

The second letter is for the quality of the oil. The more highly the letter in the alphabet, the better the quality.

API C for diesel engine

Examples for diesel engine oil:

API CC Engine oil for small demands

API CD Engine oil for suction- and turbo diesel engine

API CF Replace the specification API CD since 1994

API CG Engine oil for highest demands, turbo-tested

**See technical data for the specified engine oil**

**Notice!:**

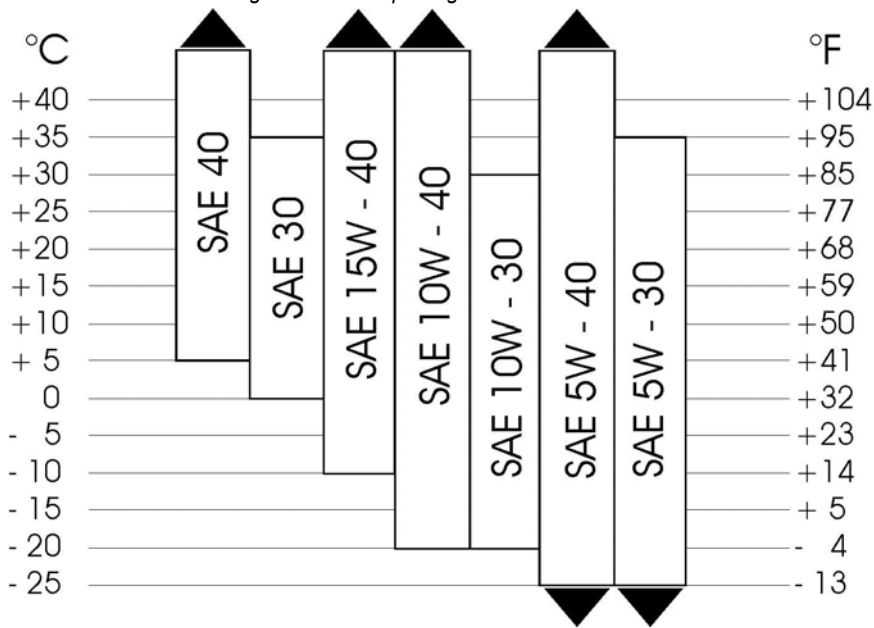


Fig. 9.5.1.2-1: Engine oil type.

Engine oil type	
over 25 °C	SAE30 or SAE10W-30; SAE10W-40
0 °C to 25 °C	SAE20 or SAE10W-30; SAE10W-40
below 0 °C	SAE10W or SAE10W-30; SAE10W-40



Fig. 9.5.1-2: Temp. range of the SAE classes



## 9.6 Coolant specifications

Use a mixture of water and antifreeze. The antifreeze needs to be suitable for aluminium. The antifreeze concentration must be regularly checked in the interests of safety.

Fischer Panda recommend to use the product: GLYSANTIN PROTECT PLUS/G 48

Engine coolant automotive industry Product description		
Product name	GLYSANTIN® PROTECT PLUS / G48	
Chemical nature	Monoethylenglycol with inhibitors	
Physical form	Liquid	
Chemical and physical properties		
Reserve alkalinity of 10ml	ASTM D 1121	13 – 15 ml HCl 01 mol/l
Density, 20°C	DIN 51 757 procedure 4	1,121 – 1,123 g/cm <sup>3</sup>
Water content	DIN 51 777 part 1	max. 3,5 %
pH-value undiluted		7,1 – 7,3

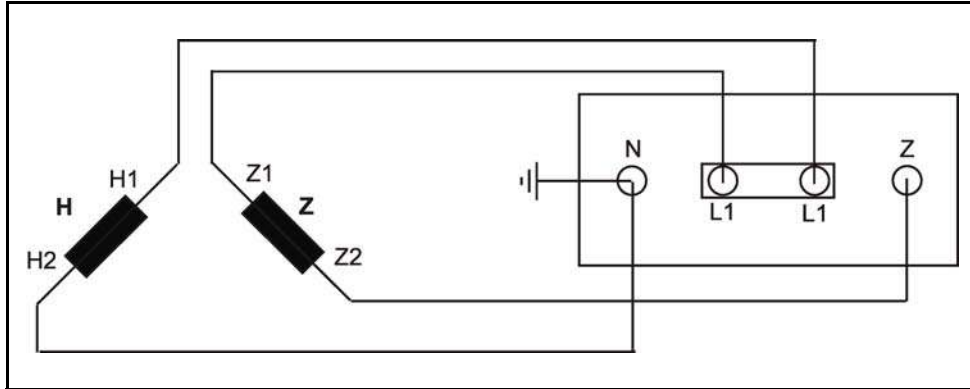
### 9.6.1 Coolant mixture ratio

Water/antifreeze	Temperature
70:30	-20°C
65:35	-25°C
60:40	-30°C
55:45	-35°C
50:50	-40°C

## 9.7 Types of coil

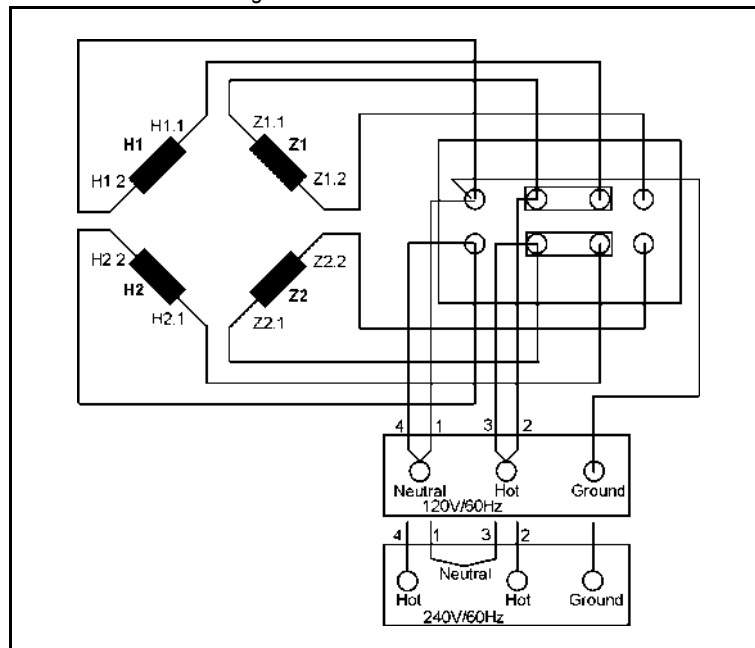
### 9.7.1 HP1 - 230V / 50 Hz

Fig. 9.7.1-1: HP1 - 230V / 50 Hz



### 9.7.2 HP2 - 120V / 60 Hz

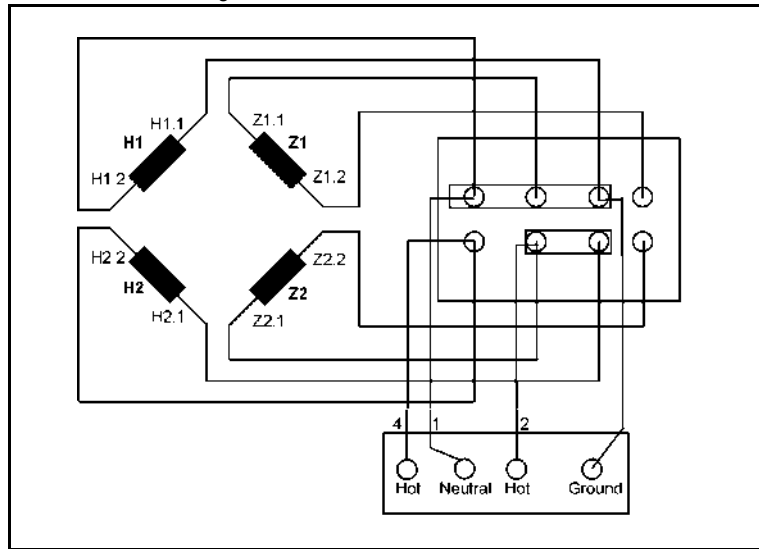
Fig. 9.7.2-1: HP2 - 120V / 60 Hz



### 9.7.3 HP2 - 120V / 60 Hz - Duo

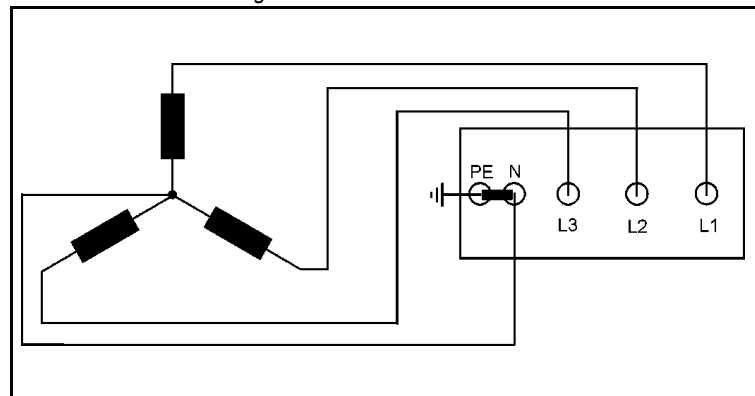


Fig. 9.7.3-1: HP2 - 120V / 60 Hz - Duo



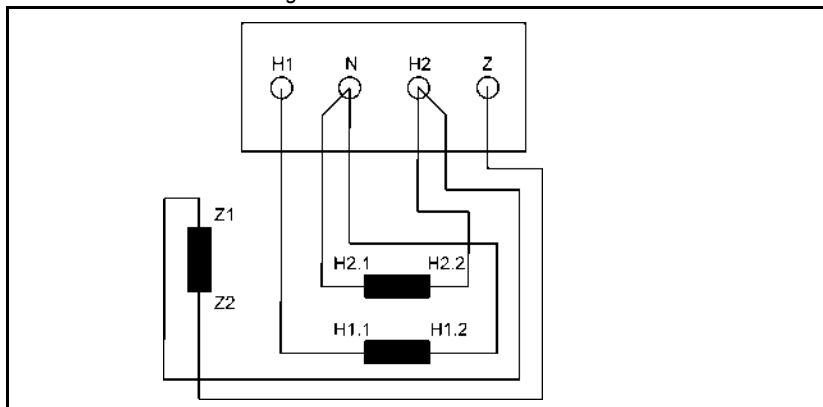
## 9.7.4 HP3 - 400V / 50 Hz

Fig. 9.7.4-1: HP3 - 400V / 50 Hz



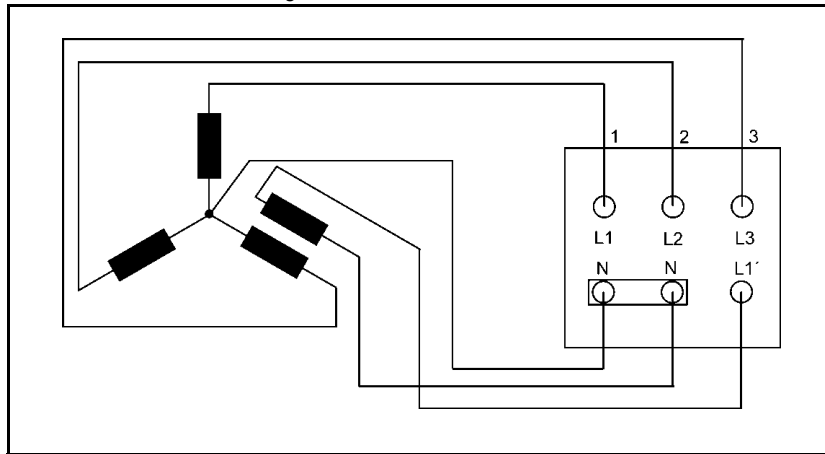
## 9.7.5 HP2 - 120V / 60 Hz

Fig. 9.7.5-1: HP3 - 120V / 60 Hz



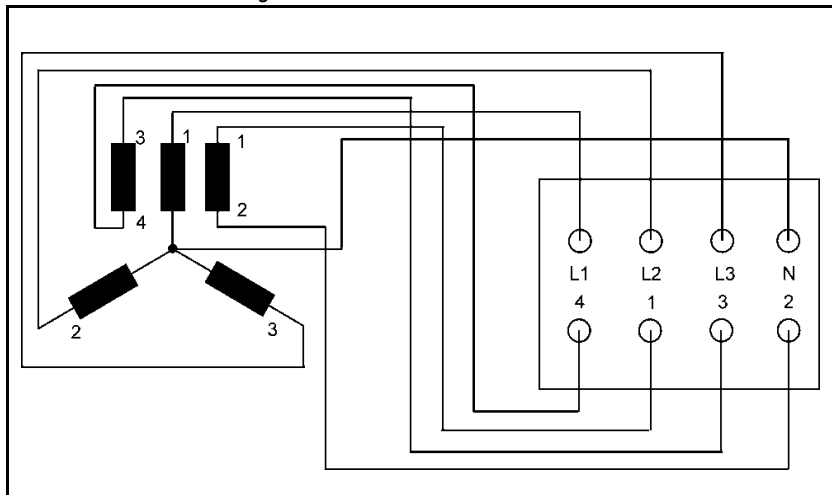
## 9.7.6 DVS - 400V / 50 Hz

Fig. 9.7.6-1: DVS - 400V / 50 Hz



### 9.7.7 DVS - 120V 240V / 60 Hz

Fig. 9.7.7-1: DVS - 120V 240V / 60 Hz



## 9.8 Resistor & inductance of the generator coil

Fig. 9.8-1: Resistor + inductance generator coil HP1

	L-N[Ohm]	L-Z[Ohm]		L-N[Ohm]	L-Z[Ohm]
<b>Mains</b>	<b>120V / 60Hz</b>		<b>Mains</b>	<b>120V / 60Hz</b>	
Panda 8000	ca. 0,7	ca. 0,7	Panda 8000	ca. 2,8	ca. 2,8
Panda 9000	ca. 0,65	ca. 0,65	Panda 9000	ca. 2,8	ca. 2,8
Panda 12000	ca. 0,45	ca. 0,45	Panda 12000	ca. 3,5	ca. 3,5
Panda 18	ca. 0,2	ca. 0,2	Panda 18	ca. 3,2	ca. 3,2
Panda 24	ca. 0,06	ca. 0,06	Panda 24	ca. 0,3	ca. 0,3
<b>Mains:</b>	<b>230V / 50Hz</b>		<b>Mains:</b>	<b>230V / 50Hz</b>	
Panda 8000	ca. 0,9	ca. 0,9	Panda 8000	ca. 3,7	ca. 3,7
Panda 9000	ca. 0,8	ca. 0,8	Panda 9000	ca. 3,7	ca. 3,7
Panda 12000	ca. 0,3	ca. 0,3	Panda 12000	ca. 3,5	ca. 3,5
Panda 14000	ca. 0,25	ca. 0,25	Panda 14000	ca. 2,3	ca. 2,3
Panda 18	ca. 0,25	ca. 0,25	Panda 18	ca. 1,8	ca. 1,8
Panda 24	ca. 0,17	ca. 0,17	Panda 24	ca. 1,3	ca. 1,3
Panda 30	ca. 0,1	ca. 0,1	Panda 30	ca. 0,9	ca. 0,9

Fig. 9.8-2: Resistor generator coil DVS

	L1-N[Ohm]	L2-N[Ohm]	L3-N[Ohm]	L1'-N[Ohm]	1-2[Ohm]	3-4[Ohm]
<b>Mains</b>	<b>120V / 60Hz</b>					
Panda 8000	ca. 0,7	ca. 0,7	ca. 0,7	ca. 0,15	ca. 0,15	
Panda 9000	ca. 0,65	ca. 0,65	ca. 0,65	ca. 0,17	ca. 0,17	
Panda 12000	ca. 0,45	ca. 0,45	ca. 0,45	ca. 0,15	ca. 0,15	
Panda 18	ca. 0,2	ca. 0,2	ca. 0,2	ca. 0,05	ca. 0,05	
Panda 24	ca. 0,06	ca. 0,06	ca. 0,06			
<b>Mains:</b>	<b>230V / 50Hz</b>					
Panda 8000	ca. 0,9		ca. 0,9		ca. 0,9	ca. 0,4
Panda 9000	ca. 0,8		ca. 0,8		ca. 0,8	ca. 0,4
Panda 12000	ca. 0,3		ca. 0,3		ca. 0,3	ca. 0,2
Panda 14000	ca. 0,25	ca. 0,25	ca. 0,25	ca. 0,12		
Panda 18	ca. 0,25	ca. 0,25	ca. 0,25	ca. 0,1		
Panda 24	ca. 0,17	ca. 0,17	ca. 0,17	ca. 0,1		
Panda 30	ca. 0,1	ca. 0,1	ca. 0,1	ca. 0,08		

Fig. 9.8-3: Inductance generator coil DVS

	L1-N[mH]	L2-N[mH]	L3-N[mH]	L1'-N[mH]	1-2[mH]	3-4[mH]
<b>Mains</b>	<b>120V / 60Hz</b>					
Panda 8000	ca. 2,8	ca. 2,8	ca. 2,8	ca. 0,8	ca. 0,8	
Panda 9000	ca. 2,8	ca. 2,8	ca. 2,8		ca. 0,9	ca. 0,9
Panda 12000	ca. 3,5	ca. 3,5	ca. 3,5	ca. 1,0	ca. 1,0	
Panda 18	ca. 3,2	ca. 3,2	ca. 3,2		ca. 0,4	ca. 0,4
Panda 24	ca. 0,3	ca. 0,3	ca. 0,3			
<b>Mains:</b>	<b>230V / 50Hz</b>					
Panda 8000	ca. 3,7	ca. 3,7	ca. 3,7	ca. 2,3		
Panda 9000	ca. 3,7	ca. 3,7	ca. 3,7	ca. 2,3		
Panda 12000	ca. 3,5	ca. 3,5	ca. 3,5	ca. 2,3		
Panda 14000	ca. 2,3	ca. 2,3	ca. 2,3	ca. 1,5		
Panda 18	ca. 1,8	ca. 1,8	ca. 1,8	ca. 1,1		
Panda 24	ca. 1,3	ca. 1,3	ca. 1,3	ca. 0,8		
Panda 30	ca. 0,9	ca. 0,9	ca. 0,9	ca. 0,6		

## 9.9 Voltage values stator coil

Fig. 9.9-1: Voltage values stator coil HP3

Terminal	Panda 8000	Panda 9000	Panda 12000	Panda 14000	Panda 18	Panda 24	Panda 30
L1 - L2	3-5 Volt	4-6 Volt	5-7 Volt	6-9 Volt	6-10 Volt	6-11 Volt	7-12 Volt
L2 - L3	3-5 Volt	4-6 Volt	5-7 Volt	6-9 Volt	6-10 Volt	6-11 Volt	7-12 Volt
L3 - L1	3-5 Volt	4-6 Volt	5-7 Volt	6-9 Volt	6-10 Volt	6-11 Volt	7-12 Volt
L1' - N (50Hz)	~ 2-3 Volt	~ 2-3 Volt	~ 3-4 Volt	~ 3-5 Volt	~ 3-5 Volt	~ 3-5 Volt	~ 3-6 Volt
4 - 2 (60Hz)	~ 2-3 Volt	~ 2-3 Volt	~ 3-4 Volt		~ 3-5 Volt	~ 3-5 Volt	

Fig. 9.9-2: Voltage values stator coil HP1

Terminal	Panda 8000	Panda 9000	Panda 12000	Panda 14000	Panda 18	Panda 24	Panda 30
L - N	~ 2-3 Volt	~ 2-3 Volt	~ 3-4 Volt	~ 3-5 Volt	~ 3-5 Volt	~ 3-5 Volt	~ 3-6 Volt
4 - 2 (60Hz)	~ 2-3 Volt	~ 2-3 Volt	~ 3-4 Volt		~ 3-5 Volt	~ 3-5 Volt	

If your generator is not mentioned, ask your local Fischer Panda Dealer for the technical datas coil.



## 9.10 Diameter of conduits

Fig. 9.10-1: Diameter of conduits

Generator type	Ø Cooling water conduit		Ø Exhaust conduit [mm]	Ø Fuel conduit	
	Freshwater [mm]	Seawater [mm]		Supply [mm]	Return [mm]
Panda PMS 3,8 ND	12	12	30	8	8
Panda PMS 4,5 ND	12	12	30	8	8
Panda PMS 4500 SCB	12	12	30	8	8
Panda PMS 5000 SCE	12	12	30	8	8
Panda PMS 4500 FCB	12	12	30	8	8
Panda PMS 5000 LPE	16	16	30	8	8
Panda PMS 6000 ND	20	20	40	8	8
Panda PMS 8000 NE (8 mini Digital)	20	20	40	8	8
Panda PMS 9000 ND	20	20	40	8	8
Panda PMS 12000 NE (12 mini Digital)	20	20	40	8	8
Panda PMS 14000 NE	20	20	40	8	8
Panda PMS 18 NE (16 Digital)	25	20	50	8	8
Panda PMS 24 NE (22/25 Digital)	25	20	50	8	8
Panda PMS 30 NE	25	20	50	8	8
Panda PMS 33 KU	30	25	50	8	8
Panda PMS 42 KU	30	30	50	8	8
Panda PMS 32 YA	30	30	50	8	8
Panda PMS 50 YA	30	30	60	8	8
Panda PMS 60 YA	-	-	60	8	8
Panda PMS 50 MB	40	30	60	8	8
Panda PMS 60 MB	40	40	60	8	8
Panda PMS 75 MB	40	30	60	8	8
Panda PMS-HD 7,5-4 KU	25	20	40	8	8
Panda PMS-HD 09-4 KU	25	20	50	8	8
Panda PMS-HD 12-4 KU	25	20	50	8	8
Panda PMS-HD 17-4 KU	25	25	60	8	8
Panda PMS-HD 22-4 KU	30	30	60	8	8
Panda PMS-HD 30-4 KU	30	30	60	8	8
Panda PMS-HD 40-4 KU	30	30	60	8	8
Panda PMS-HD 60-4 DZ	-	-	-	-	-
Panda PMS-HD 70-4 DZ	-	-	-	-	-
Panda PMS-HD 85-4 DZ	-	-	-	-	-
Panda PMS-HD 110-4 DZ	-	-	-	-	-
Panda PMS-HD 130-4 DZ	-	-	-	-	-



Leere Seite / Intentionally blank





# Fischer Panda®

Power  
wherever  
you are™



## Generator Control Panel P6+ Manual

12V version - 21.02.02.046P

24V special version - 21.02.02.047P

Option automatic adapter - 21.02.02.016P

Option master-slave adapter - 21.02.02.015P

Fischer Panda GmbH



## Current revision status

	Document
<b>Actual:</b>	Panel Generator Control P6+ RE0703_Kunde_eng.R08_3.9.14
<b>Replace:</b>	Panel Generator Control P6+ RE0703_Kunde_eng.R07_24.11.11

Revision	Page
New article numbers	

## Hardware

Generator	Revision	Modification Strike Plate	Date	Upgrade

### Created by

Fischer Panda GmbH - Head of Technical Documentation

Otto-Hahn-Str. 32-34

33104 Paderborn - Germany

Phone: +49 (0) 5254-9202-0

E-Mail: [info@fischerpanda.de](mailto:info@fischerpanda.de)

web: [www.fischerpanda.de](http://www.fischerpanda.de)

### Copyright

Reproduction and modification of the manual is permitted only after agreement with the manufacturer!

Fischer Panda GmbH, 33104 Paderborn, reserves all rights regarding text and graphics in this document. Details are given to the best of our knowledge. No liability is accepted for correctness. Please note: technical modifications aimed at improving the product may be implemented without prior notice. Therefore, it must be ensured prior to installation that the pictures, diagrams and related material are applicable to the genset supplied. In case of doubt, verify upon delivery that documentation and equipment match.



## 10. Safety Instructions Generator Control P6+

### 10.1 Personal requirements

---

The settings described here can be performed by the operator, unless otherwise indicated.

The installation should be carried out by specially trained personnel or by authorized repair shops (Fischer Panda service points).

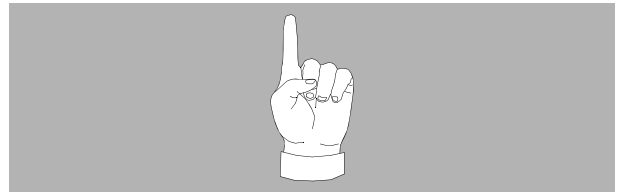
### 10.2 Safety instructions

---

**Follow the general safety instruction at the front of this manual.**

If these not exist, they can be requested at Fischer Panda GmbH, 33104 Paderborn.

**Note!**



**Danger for life! - The generator can be equipped with an automatic start device. This means expected starting of the generator, the starter battery must be disconnected before start working at the generator.**

**Warning! Automatic start**



**The generator must not be put into operation with cover removed.**

If the generator is mounted without sound cover, the rotating parts (pulley, belt, etc.) must be covered and protected so that an injury is excluded.

**Warning!**



All service, maintenance or repair work on the unit may be made only while the motor is off.

**Danger for Life. Improper handling, operation, installation and maintenance can result in severe personal injury and/or material damage.**

**Warning! Danger of Life - High voltage**



Electrical voltages above 48 volts (battery chargers greater than 36 volts) are always dangerous to life). The rules of the respective regional authority must be adhered to. Only an electrician may carry out installation of the electrical connections for safety reasons.

**Disconnect the battery when working on the generator.**

**Attention!**



The battery must always be disconnected (first negative then positive pole), when work on the generator or the electrical system of the generator are made, so that the generator can not be started accidentally.

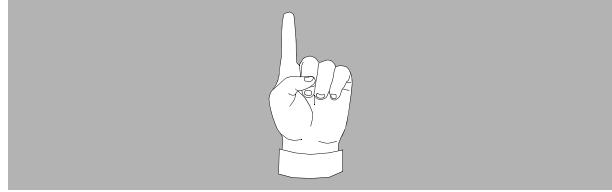
This is especially true for systems with an automatic start function. The automatic start function is to be deactivated

before the work.

*Sea valve must be closed. (only PMS version)*

**Note also the safety of the other components of your system.**

**Note!**

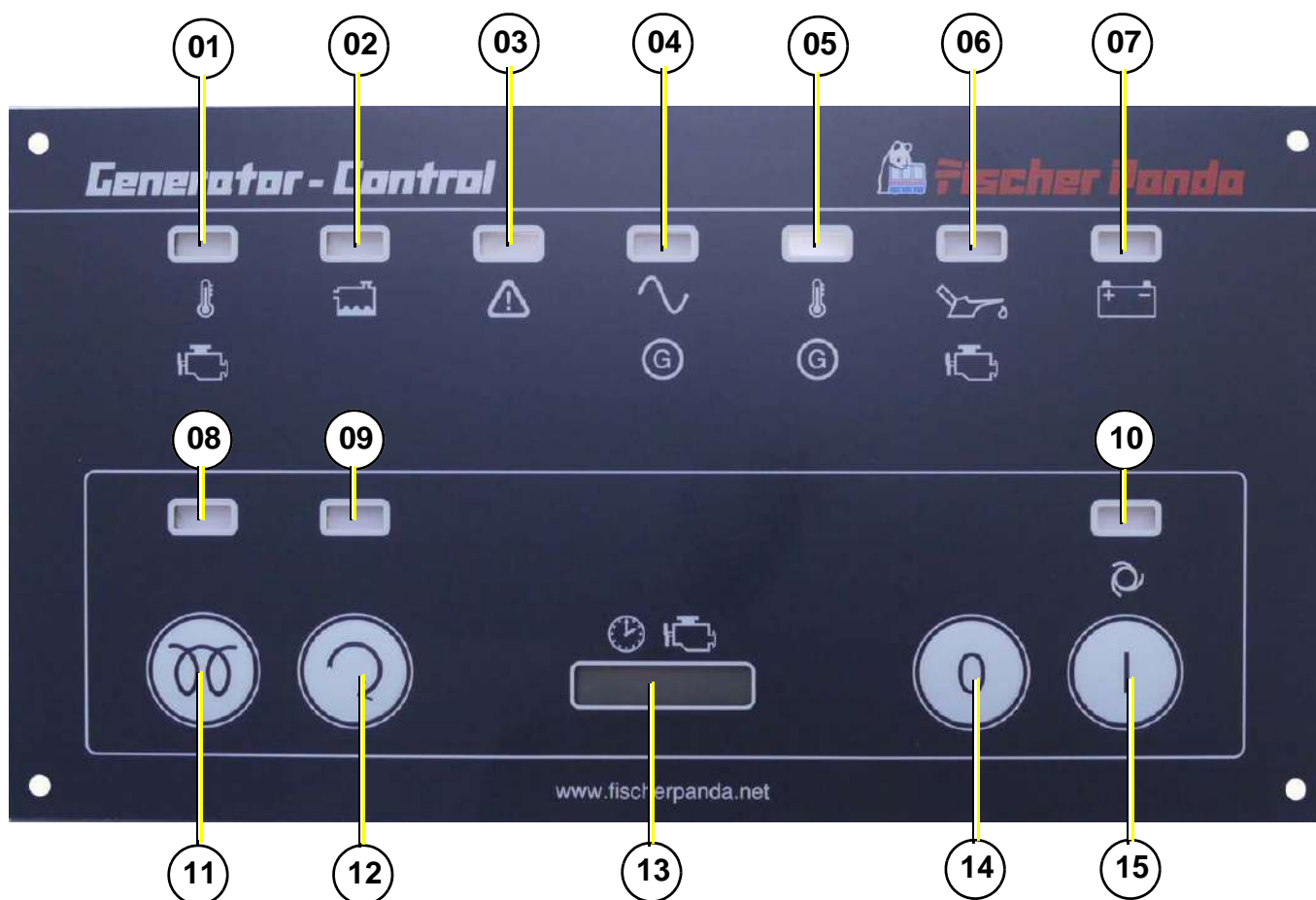


## 11. General operation

### 11.1 Panel Generator Control

Fischer Panda Art. No. 21.02.02.009P

Fig. 11.1-1: Panel front



- 01. LED for coolant temperature red<sup>1</sup>
- 02. LED for water leak red/yellow<sup>1</sup> (sensor optional)
- 03. LED for AC-voltage fault red/yellow<sup>1</sup>
- 04. LED for AC-voltage ok green<sup>1</sup>
- 05. LED for winding temperature red<sup>1</sup>
- 06. LED for oil pressure red<sup>1</sup>
- 07. LED for battery charge voltage fault green/red<sup>1</sup>

- 08. LED for pre-glow „heat“ orange<sup>1</sup>
- 09. LED for Generator „start“ green<sup>1</sup>
- 10. LED for Generator „stand-by“ green<sup>1</sup>
- 11. Push button for pre-glow „heat“
- 12. Push button for Generator „start“
- 13. Operating hours counter
- 14. Push button panel „off“
- 15. Push button panel „on“

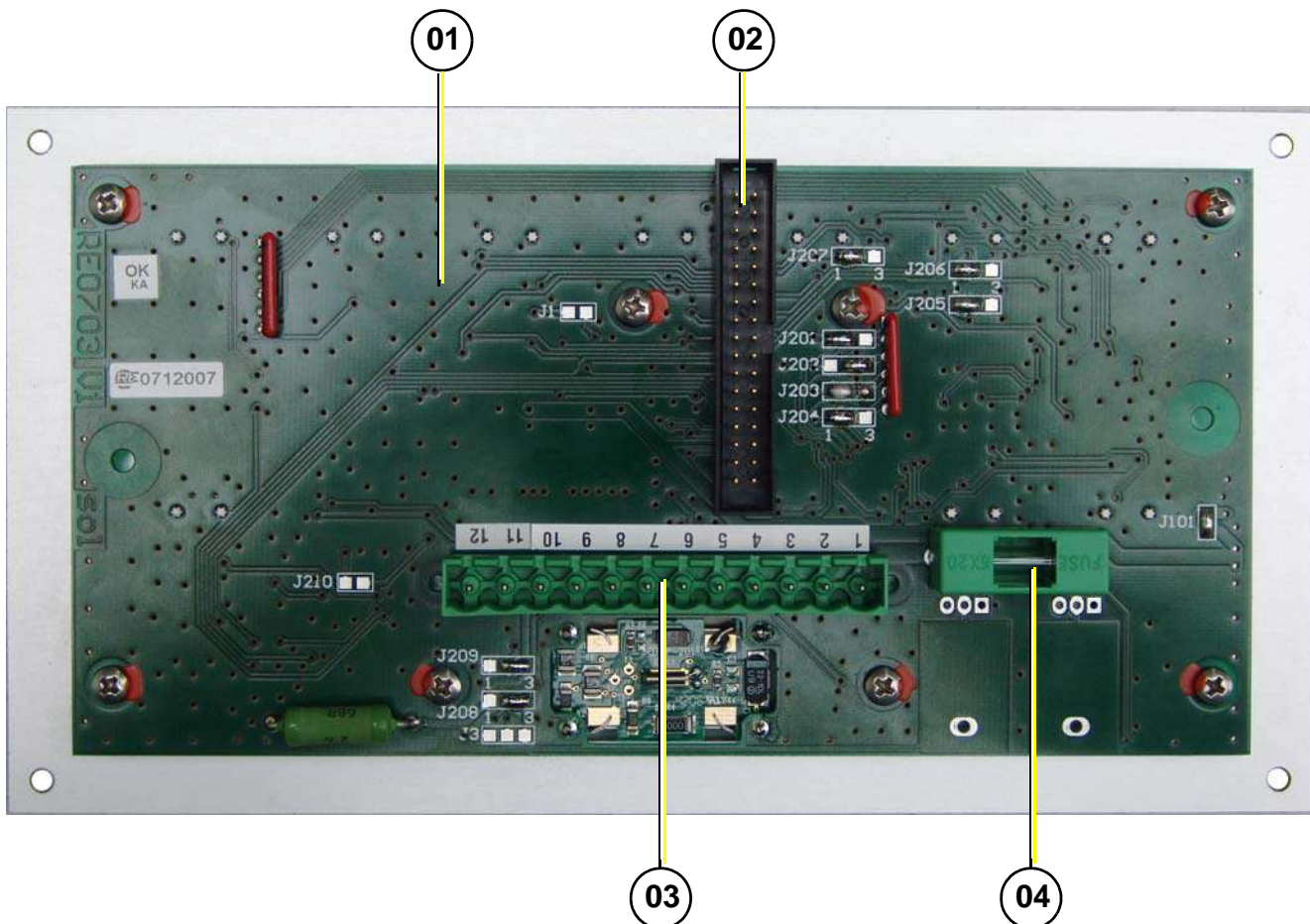
LED green: normal operation mode, LED red: fault, LED yellow: warning, LED orange: active



## 11.1 Rear view 12 V-version

Fischer Panda Art. No. 21.02.02.009P

Fig. 11.1-1: Panel rear view 12 V-version

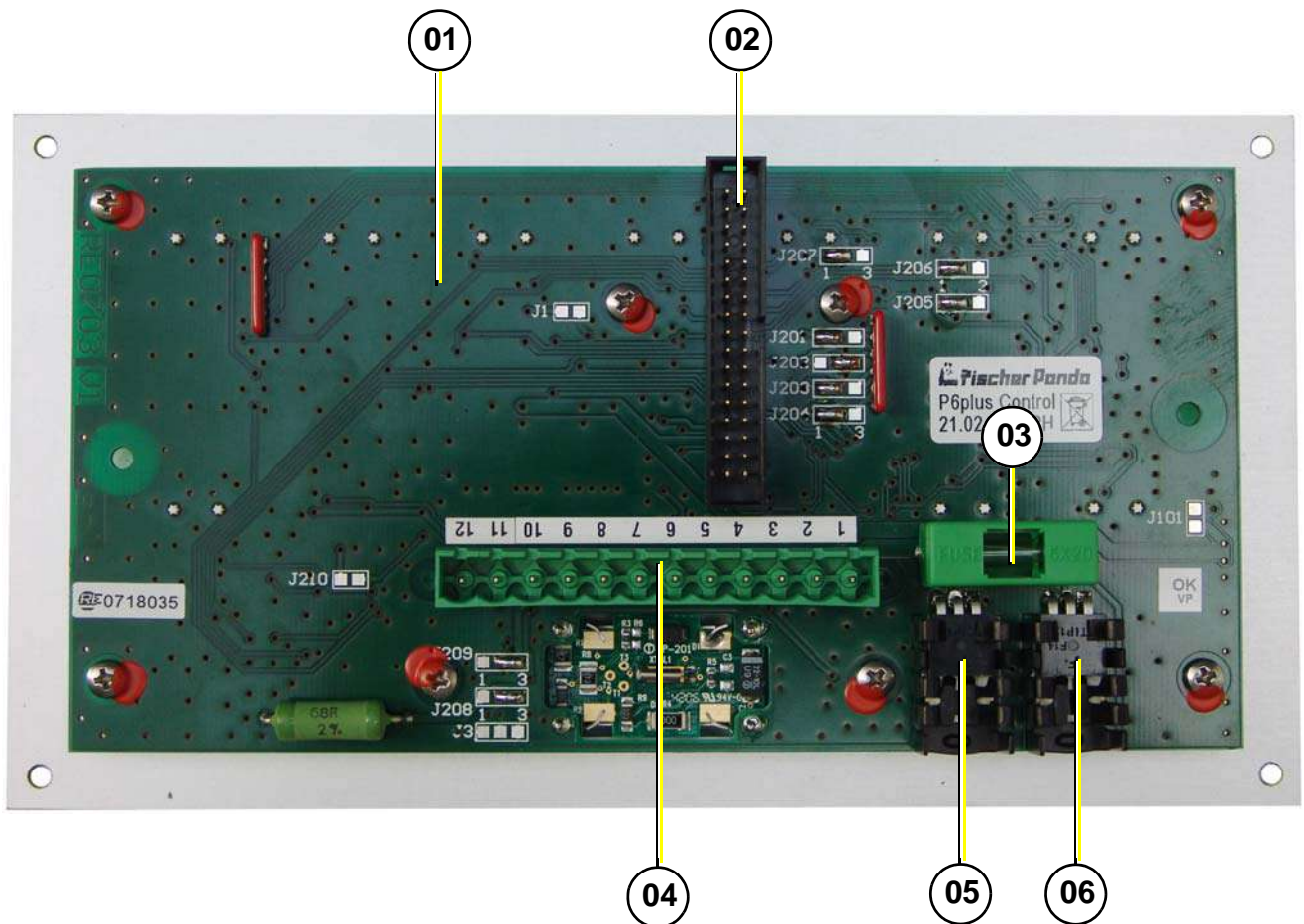


- 01. Control board
- 02. Terminal block (master-slave adapter: left row; automatic adapter: right row)
- 03. Terminals 1-12 (see section 11.3.2, "Terminal connections," on page 216)
- 04. Fuse 630 mA slow-blow

## 11.2 Rear view 24 V-version

Fischer Panda Art. No. 21.02.02.012P

Fig. 11.2-1: Panel rear view 24 V-version



- 01. Control board
- 02. Terminal block (master-slave adapter: left row; automatic adapter: right row)
- 03. Fuse 630 mA slow-blow
- 04. Terminals 1-12 (see section 11.3.2, "Terminal connections," on page 216)
- 05. Linear controller 24 V
- 06. Linear controller 24 V



### 11.3 Installation of the remote control panel

#### 11.3.1 Placement.

Install the remote control panel at a dry, good accessible and shady place.

Connect the remote control panel to the standard 12 core cable at the generator. (1:1)

#### 11.3.2 Terminal connections

Standard for NC temperature switch configured i.e. in case of failure „open“.

Fig. 11.3.2-1: Terminal connections

Clamp no.	Clamp name	IN / OUT	Description
1	Vbat	IN	power supply + 12 V (or optional 24 V, must be adjusted by jumper)
2	GND	IN	power supply -
3	T-Engine	IN	Error "coolant temperature". Input for thermo-switch to GND. The input is adjustable for NC/NO (N = no error) (must be adjusted by solder Jumper). The input loads the switch with $\geq 22$ mA to +12 V (with 24 V-operated internally generated). The occurrence of an error is delayed, for analysis and displayed, around 100ms. Omission not. The in/out status is indicated with red LED.
4	Water leak (Replace air filter)	IN	Error "water leak". Input for sensor switch to GND. The input is adjustable for NC/NO (N = no error) (must be adjusted by solder Jumper). The input loads the switch with $\geq 10$ mA to +12 V (with 24 V-operated internally generated). The occurrence of an error is delayed, for analysis and displayed, around 100 ms. Omission not. The input status is indicated with red LED.  The input can be used alternatively for the signal "Replace air filter" (must be adjusted by solder Jumper). Then the signal does not lead to switching off and is indicated with yellow LED.
5	Oil-Press	IN	Error "oil pressure". Input for oil pressure switches to GND. The input is adjustable for NC/NO (N = no error) (must be adjusted by solder Jumper). The input loads the switch with $\geq 22$ mA to +12 V (with 24 V-operated internally generated). The occurrence of an error is delayed, for analysis and displayed, around 1s. Omission not. The input status is indicated with red LED.
6	DC-Control	IN / OUT	Load control display. Input for signal of the dynamo. The input is adjustable for GND = OK or 12 V/ 24 V = OK (must be adjusted by solder Jumper). The input loads the signal with 5 mA at 12 V and 10 mA at 24 V. The input status is indicated with red and green LED.  The connection can supply an energizing current for the dynamo over a fixed resistor with 68R. Either with the control panel switched on or with "Fuel pump" switched on (must be adjusted by solder Jumper). This function is available only in 12 V-operation.
7	AC-Control	IN	AC control display. Input for NC-open-collector-sensor-switch to GND (N = OK). The input loads the switch with $\geq 2,5$ mA to +12 V (with 24 V-operated internally generated). The input status is indicated with red and green LED's.
8	Heat	OUT	Output for pre-glow relays. The output is so long active, as the button "Heat" is pressed. The output supplies, if active, the voltage of clamp 1. Additionally the output can be operated via the button "start" (must be adjusted by solder Jumper). Consider (notes 1-4).
9	Fuel-Pump	OUT	Output for fuel pump relay. The output is active, if no error is present (inputs 3, 4, 5, 11 and 12, if configured accordingly). The button "start" suppresses the error analysis and the output is then also active in the case of error, if the button "start" is pressed. The output supplies, if active, the voltage of clamp 1. Consider (notes 1-4).
10	Start	OUT	Output for starting relay. The output is active, as long as the button "start" is pressed. The output supplies, if active, the voltage of clamp 1. Consider (notes 1-4).
11	AC-Fault (Fuel Level) [former T-Oil]	IN	Error generator AC input for NC-open-collector-sensor-switch to GND (N = no error). The input loads the switch with $\geq 2,5$ mA to +12 V. (with 24 V-operated internally generated). The occurrence of an error is delayed, for analysis and displayed, around 100ms. Omission not. The input status is indicated with red LED.  The input can be used alternatively for the signal "Fuel level" (must be adjusted by solder Jumper). The signal does not lead to switching off and is indicated with yellow LED.  The input can be used alternatively for the signal "error oil-temperature". The input is adjustable for NC/NO (N = no error) (must be adjusted by solder Jumper). The load of the sensor switch is adjustable to $\geq 10$ mA by +12 V (must be adjusted by solder Jumper).



Clamp no.	Clamp name	IN / OUT	Description
12	T-Winding	IN	Error "winding temperature". Input for thermo-switch to GND. The input is adjustable for NC/NO (N = no error) (must be adjusted by solder Jumper). The input loads the switch with $\geq 22$ mA to +12 V (with 24 V-operated internally generated). The occurrence of an error is delayed, for analysis and displayed, around 100 ms. Omission not. The input status is indicated with red LED.

Notes:

Power rating of the output: max. 0,5 A in continuous operation and briefly 1,0 A.

The supply of all output currents may not exceed (less 0,2 A power consumption) the rated current of the safety device of the control panel.

The output has a free wheeling diode, which short circuits negative voltages (related to GND).

The output has a Z-diode, which prevents a supply of positive voltage (related to GND) into the output.

### 11.3.3 Function of the jumpers

Fig. 11.3.3-1: Function of the solder jumper

Jumper	Status	Description
J1	closed	during operation of the start button heat is along-operated
	open	Function deactivated
J3	1-2	Dynamo excitation resistor 68R is switched on with Fuel-Pump (1)
	2-3	Dynamo excitation resistor 68R is switched on with Panel-ON (1)
	open	Dynamo excitation resistor is deactivated
J101	closed	12 V - operation
	open	24 V - operation (optional)
J201	1-2	T-Engine-input, for contact, which opens in case of error (2)
	2-3	T-Engine-input, for contact, which closes in case of error (2)
J202	1-2	Water leak-input / Replace air filter, for contact, which opens in case of error (2)
	2-3	Water leak-input / Replace air filter, for contact, which closes in case of error (2)
J203	1-2	Oil-Press-input, for contact, which opens in case of error (2)
	2-3	Oil-Press-input, for contact, which closes in case of error (2)
J204	1-2	AC-Fault-input / Fuel level, for contact, which opens in case of error (2)
	2-3	AC-Fault-input / Fuel level, for contact, which closes in case of error (2)
J205	1-2	T-Winding-input, for contact, which opens in case of error (2)
	2-3	T-Winding-input, for contact, which closes in case of error (2)
J206	1-2	Input Water leak has red LED and switches off
	2-3	Input Water leak has yellow LED and does not switch off
J207	1-2	Input AC-Fault has red LED and switches off
	2-3	Input AC-Fault has yellow LED and does not switch off
J208	1-2	DC-Control-Signal (-) = OK dynamo 12 V at Kubota Z 482 / D 722 engines
	2-3	DC-Control-Signal (+) = OK three-phase DC-alternator
J209	1-2	DC-Control-Signal (-) = OK dynamo 12 V at Kubota Z 482 / D 722 engines
	2-3	DC-Control-Signal (+) = OK three-phase DC-alternator
J210	closed	Input AC-Fault has Pull-Up-current $\geq 10$ mA
	open	Input AC-Fault has Pull-Up-current $\geq 2,5$ mA

The solder jumpers are marked on the printed circuit board (with jumper no. and at three-part solder jumper with soldering surface no.)

(1): Equivalent resistance for load control lamp e.g. for use with three-phase alternator also integrated automatic controller of Bosch. The resistance value is  $68 \Omega$  3 W, i.e. only for 12 V.

(2): A closed contact switches the appropriate input to GND.



### 11.3.4 Configuration and adjustment

#### 11.3.4.1 Configuration and setting sheet KE01

Standard jumpering for generators with three-phase DC-alternator (Kubota Super 5 series).

Panel only for 12 V-operation.

The safety device is installed with the value 0,63 AT.

The circuit parts for 24 V-operation are not equipped.

Fig. 11.3.4.1-1: Settings of soldered jumper for this configuration (column Conf.)

Jumper	Status	Conf.	Description
J1	closed		during operation of the start button heat is along-operated
	open	X	Function deactivated
J3	1-2		Dynamo excitation resistor 68R is switched on with Fuel-Pump (1)
	2-3		Dynamo excitation resistor 68R is switched on with Panel-ON (1)
	open	X	Dynamo excitation resistor is deactivated
J101	closed	X	12 V - operation
	open		<del>24 V - operation</del> (not possible)
J201	1-2	X	T-Engine-input, for contact, which opens in case of error (2)
	2-3		T-Engine-input, for contact, which closes in case of error (2)
J202	1-2		Water leak-input / Replace air filter, for contact, which opens in case of error (2)
	2-3	X	Water leak-input / Replace air filter, for contact, which closes in case of error (2)
J203	1-2	X	Oil-Press-input, for contact, which opens in case of error (2)
	2-3		Oil-Press-input, for contact, which closes in case of error (2)
J204	1-2	X	AC-Fault-input / Fuel level, for contact, which opens in case of error (2)
	2-3		AC-Fault-input / Fuel level, for contact, which closes in case of error (2)
J205	1-2	X	T-Winding-input, for contact, which opens in case of error (2)
	2-3		T-Winding-input, for contact, which closes in case of error (2)
J206	1-2	X	Input Water leak has red LED and switches off
	2-3		Input Water leak has yellow LED and does not switch off
J207	1-2	X	Input AC-Fault has red LED and switches off
	2-3		Input AC-Fault has yellow LED and does not switch off
J208	1-2		DC-Control-Signal (-) = OK dynamo 12 V at Kubota Z 482 / D 722 engines
	2-3	X	DC-Control-Signal (+) = OK three-phase DC-alternator
J209	1-2		DC-Control-Signal (-) = OK dynamo 12 V at Kubota Z 482 / D 722 engines
	2-3	X	DC-Control-Signal (+) = OK three-phase DC-alternator
J210	closed		Input AC-Fault has Pull-Up-current $\geq 10$ mA
	open	X	Input AC-Fault has Pull-Up-current $\geq 2,5$ mA

The solder jumpers are marked on the printed circuit board (with jumper no. and at three-part solder jumper with soldering surface no.)

(1): Equivalent resistance for load control lamp e.g. for use with three-phase alternator also integrated automatic controller of Bosch. The resistance value is 68  $\Omega$  3 W, i.e. only for 12 V.

(2): A closed contact switches the appropriate input to GND.

### 11.3.4.2 Configuration and setting sheet KE02

Standard jumpering for generators with three-phase DC-alternator.

Panel for 24 V-operation (over attitude of solder jumper J101 alternatively 12 V-operation is possible).

The safety device is installed with the value 0,63 AT.

The circuit parts for 24 V-operation are not equipped.

Fig. 11.3.4.2-1: Settings of soldered jumper for this configuration (column Conf.)

Jumper	Status	Conf.	Description
J1	closed		during operation of the start button heat is along-operated
	open	X	Function deactivated
J3	1-2		Dynamo excitation resistor 68R is switched on with Fuel-Pump (1)
	2-3		Dynamo excitation resistor 68R is switched on with Panel-ON (1)
	open	X	Dynamo excitation resistor is deactivated
J101	closed		12 V - operation
	open	X	24 V - operation
J201	1-2	X	T-Engine-input, for contact, which opens in case of error (2)
	2-3		T-Engine-input, for contact, which closes in case of error (2)
J202	1-2		Water leak-input / Replace air filter, for contact, which opens in case of error (2)
	2-3	X	Water leak-input / Replace air filter, for contact, which closes in case of error (2)
J203	1-2	X	Oil-Press-input, for contact, which opens in case of error (2)
	2-3		Oil-Press-input, for contact, which closes in case of error (2)
J204	1-2	X	AC-Fault-input / Fuel level, for contact, which opens in case of error (2)
	2-3		AC-Fault-input / Fuel level, for contact, which closes in case of error (2)
J205	1-2	X	T-Winding-input, for contact, which opens in case of error (2)
	2-3		T-Winding-input, for contact, which closes in case of error (2)
J206	1-2	X	Input Water leak has red LED and switches off
	2-3		Input Water leak has yellow LED and does not switch off
J207	1-2	X	Input AC-Fault has red LED and switches off
	2-3		Input AC-Fault has yellow LED and does not switch off
J208	1-2		DC-Control-Signal (-) = OK dynamo 12 V at Kubota Z 482 / D 722 engines
	2-3	X	DC-Control-Signal (+) = OK three-phase DC-alternator
J209	1-2		DC-Control-Signal (-) = OK dynamo 12 V at Kubota Z 482 / D 722 engines
	2-3	X	DC-Control-Signal (+) = OK three-phase DC-alternator
J210	closed		Input AC-Fault has Pull-Up-current $\geq 10$ mA
	open	X	Input AC-Fault has Pull-Up-current $\geq 2,5$ mA

The solder jumpers are marked on the printed circuit board (with jumper no. and at three-part solder jumper with soldering surface no.)

(1): Equivalent resistance for load control lamp e.g. for use with three-phase alternator also integrated automatic controller of Bosch. The resistance value is 68  $\Omega$  3 W, i.e. only for 12 V.

(2): A closed contact switches the appropriate input to GND.



### 11.3.4.3 Configuration and setting sheet KE03

Standard jumpering for generators with DC-alternator.

Panel only for 12 V-operation.

The safety device is installed with the value 0,63 AT.

The circuit parts for 24 V-operation are not equipped.

Fig. 11.3.4.3-1: Settings of soldered jumper for this configuration (column Conf.)

Jumper	Status	Conf.	Description
J1	closed		during operation of the start button heat is along-operated
	open	X	Function deactivated
J3	1-2		Dynamo excitation resistor 68R is switched on with Fuel-Pump (1)
	2-3		Dynamo excitation resistor 68R is switched on with Panel-ON (1)
	open	X	Dynamo excitation resistor is deactivated
J101	closed	X	12 V - operation
	open		<del>24 V - operation</del> (not possible)
J201	1-2	X	T-Engine-input, for contact, which opens in case of error (2)
	2-3		T-Engine-input, for contact, which closes in case of error (2)
J202	1-2		Water leak-input / Replace air filter, for contact, which opens in case of error (2)
	2-3	X	Water leak-input / Replace air filter, for contact, which closes in case of error (2)
J203	1-2	X	Oil-Press-input, for contact, which opens in case of error (2)
	2-3		Oil-Press-input, for contact, which closes in case of error (2)
J204	1-2	X	AC-Fault-input / Fuel level, for contact, which opens in case of error (2)
	2-3		AC-Fault-input / Fuel level, for contact, which closes in case of error (2)
J205	1-2	X	T-Winding-input, for contact, which opens in case of error (2)
	2-3		T-Winding-input, for contact, which closes in case of error (2)
J206	1-2	X	Input Water leak has red LED and switches off
	2-3		Input Water leak has yellow LED and does not switch off
J207	1-2	X	Input AC-Fault has red LED and switches off
	2-3		Input AC-Fault has yellow LED and does not switch off
J208	1-2	X	DC-Control-Signal (-) = OK dynamo 12 V at Kubota Z 482 / D 722 engines
	2-3		DC-Control-Signal (+) = OK three-phase DC-alternator
J209	1-2	X	DC-Control-Signal (-) = OK dynamo 12 V at Kubota Z 482 / D 722 engines
	2-3		DC-Control-Signal (+) = OK three-phase DC-alternator
J210	closed		Input AC-Fault has Pull-Up-current $\geq 10$ mA
	open	X	Input AC-Fault has Pull-Up-current $\geq 2,5$ mA

The solder jumpers are marked on the printed circuit board (with jumper no. and at three-part solder jumper with soldering surface no.)

(1): Equivalent resistance for load control lamp e.g. for use with three-phase alternator also integrated automatic controller of Bosch. The resistance value is  $68 \Omega$  3 W, i.e. only for 12 V.

(2): A closed contact switches the appropriate input to GND.



## 11.3.4.4 Configuration and setting sheet KE04

Standard jumpering for generators with DC-alternator.

Panel for 24V-operation (over attitude of solder jumper J101 alternatively 12 V-operation is possible).

The safety device is installed with the value 0,63 AT.

The circuit parts for 24 V-operation are not equipped.

Fig. 11.3.4.4-1: Settings of soldered jumper for this configuration (column Conf.)

Jumper	Status	Conf.	Description
J1	closed		during operation of the start button heat is along-operated
	closed	X	Function deactivated
J3	1-2		Dynamo excitation resistor 68R is switched on with Fuel-Pump (1)
	2-3		Dynamo excitation resistor 68R is switched on with Panel-ON (1)
	closed	X	Dynamo excitation resistor is deactivated
J101	closed		12 V - operation
	closed	X	24 V - operation
J201	1-2	X	T-Engine-input, for contact, which opens in case of error (2)
	2-3		T-Engine-input, for contact, which closes in case of error (2)
J202	1-2		Water leak-input / Replace air filter, for contact, which opens in case of error (2)
	2-3	X	Water leak-input / Replace air filter, for contact, which closes in case of error (2)
J203	1-2	X	Oil-Press-input, for contact, which opens in case of error (2)
	2-3		Oil-Press-input, for contact, which closes in case of error (2)
J204	1-2	X	AC-Fault-input / Fuel level, for contact, which opens in case of error (2)
	2-3		AC-Fault-input / Fuel level, for contact, which closes in case of error (2)
J205	1-2	X	T-Winding-input, for contact, which opens in case of error (2)
	2-3		T-Winding-input, for contact, which closes in case of error (2)
J206	1-2	X	Input Water leak has red LED and switches off
	2-3		Input Water leak has yellow LED and does not switch off
J207	1-2	X	Input AC-Fault has red LED and switches off
	2-3		Input AC-Fault has yellow LED and does not switch off
J208	1-2	X	DC-Control-Signal (-) = OK dynamo 12 V at Kubota Z 482 / D 722 engines
	2-3		DC-Control-Signal (+) = OK three-phase DC-alternator
J209	1-2	X	DC-Control-Signal (-) = OK dynamo 12 V at Kubota Z 482 / D 722 engines
	2-3		DC-Control-Signal (+) = OK three-phase DC-alternator
J210	closed		Input AC-Fault has Pull-Up-current $\geq 10$ mA
	open	X	Input AC-Fault has Pull-Up-current $\geq 2,5$ mA

The solder jumpers are marked on the printed circuit board (with jumper no. and at three-part solder jumper with soldering surface no.)

(1): Equivalent resistance for load control lamp e.g. for use with three-phase alternator also integrated automatic controller of Bosch. The resistance value is  $68 \Omega$  3 W, i.e. only for 12 V.

(2): A closed contact switches the appropriate input to GND.



## 11.4 Starting preparation / Checks (daily)

---

### 11.4.1 Marine version

---

1. Oil level control (ideal level: 2/3 MAX).

The level should be about 2/3 of the maximum level of a cold engine.

Further, if installed, the oil level of the oil-cooled bearing must be controlled before each start - see sediment bowl at generator front cover!.

2. State of cooling water.

The external expansion tank should be filled up to 1/3 of the maximum in a cold state. It is very important that a large expansion area remains above the cooling water level.

3. Check if sea cock for cooling water intake is open.

For safety reasons, the sea cock must be closed after the generator has been switched off. It should be re-opened before starting the generator.

4. Check raw water filter.

The raw water filter must be regularly checked and cleaned. The impeller fatigue increases, if residual affects the raw water intake.

5. Visual inspection.

Control fixing bolts, check hose connectors for leakages, control electrical connections.

6. Switch off the load.

The generator should only be started without load.

7. Open fuel valve, if installed.

8. Close battery main switch (on).

### 11.4.2 Vehicle version

---

1. Oil level control (ideal level: 2/3 MAX).

The level should be about 2/3 of the maximum level of a cold engine.

Further, if installed, the oil level of the oil-cooled bearing must be controlled before each start - see sediment bowl at generator front cover!.

2. State of cooling water.

The external expansion tank should be filled up to 1/3 of the maximum in a cold state. It is very important that a large expansion area remains above the cooling water level.

3. Visual inspection.

Control fixing bolts, check hose connectors for leakages, control electrical connections.

4. Switch off the load.

The generator should only be started without load.

5. Open fuel valve, if installed.

6. Close battery main switch (on).



## 11.5 Starting and stopping the generators

### 11.5.1 Starting the generator

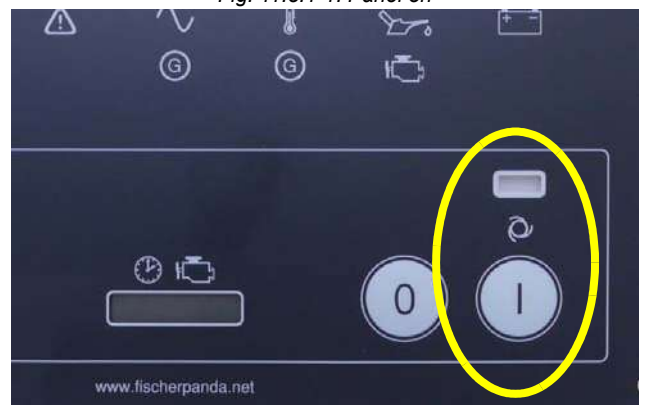
**Danger for life! - The generator can be equipped with an automatic start device. This means the generator can be started by an external signal. To avoid an unexpected starting of the generator, the starter battery must be disconnected before start working at the generator.**

**Warning!: Automatic start**



1. Press button „on“ (switch on).  
LED for „on“ = green.

Fig. 11.5.1-1: Panel on



2. Press button „heat“ (pre-glow engine).

LED for „heat“ = orange.  
Depending upon engine type and execution pre-heating can be necessary. Pre-heat is necessary at an operating temperature <20 °C.

Fig. 11.5.1-2: Pre-glow



3. Press button „start“ (start engine).

LED for „start“ = green.  
The electric starter may only be used for a maximum of 20 seconds. Thereafter, a pause of at least, 60 seconds is required. If the genset does not immediately start, then the fuel intake should be checked to ensure it is flowing freely. (For temperatures below - 8 °C check whether there is winter fuel)

4. Switch on load.

The load should only be switched on if the generator voltage is within the permissible range. Parallel connection of several loads should be avoided, especially if there are loads with electric motors, such as air-conditioning units in the system. In this case, the load must be connected Step by Step.

Fig. 11.5.1-3: Start



**In the event of starting problems, close the sea water inlet cock. Panda marine generators only.**

Should there be any reason to turn the engine (over) or start the engine i.e. to bleed the fuel system, the sea water inlet cock must be closed! During the starting process, the cooling water pump is driven with the motor. The cooling water is discharged to the exhaust outlet and, since the motor has not run, the exhaust pressure is not high enough to expel the sea water which has been brought to the exhaust outlet. To avoid filling the exhaust outlet with water and causing further problems, close the inlet sea water valve.

*Once the engine is running, be sure to open the inlet valve!*

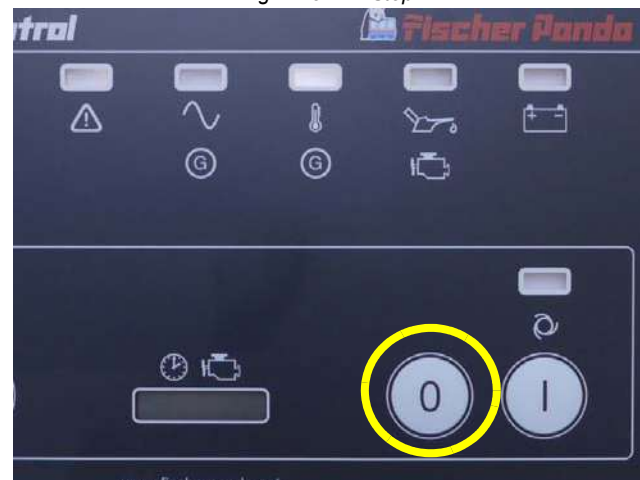
**Attention!**



## 11.5.2 Stopping the generator

1. Switch off load.
2. Recommendation: With turbo engines and during load more than highly 70 % of the rated output, stabilize generator temperature at least 5 minutes with load switched off.  
At higher ambient temperatures (more than 25 °C) the generator should always run for at least 5 minutes without load, before it is switched off, regardless of the load.
3. Press button „off“ (switch off).  
LED for „on“ = off.

Fig. 11.5.2-1: Stop



**Never switch off the battery until the generator has stopped, if necessary close fuel valve!**

**Attention!**



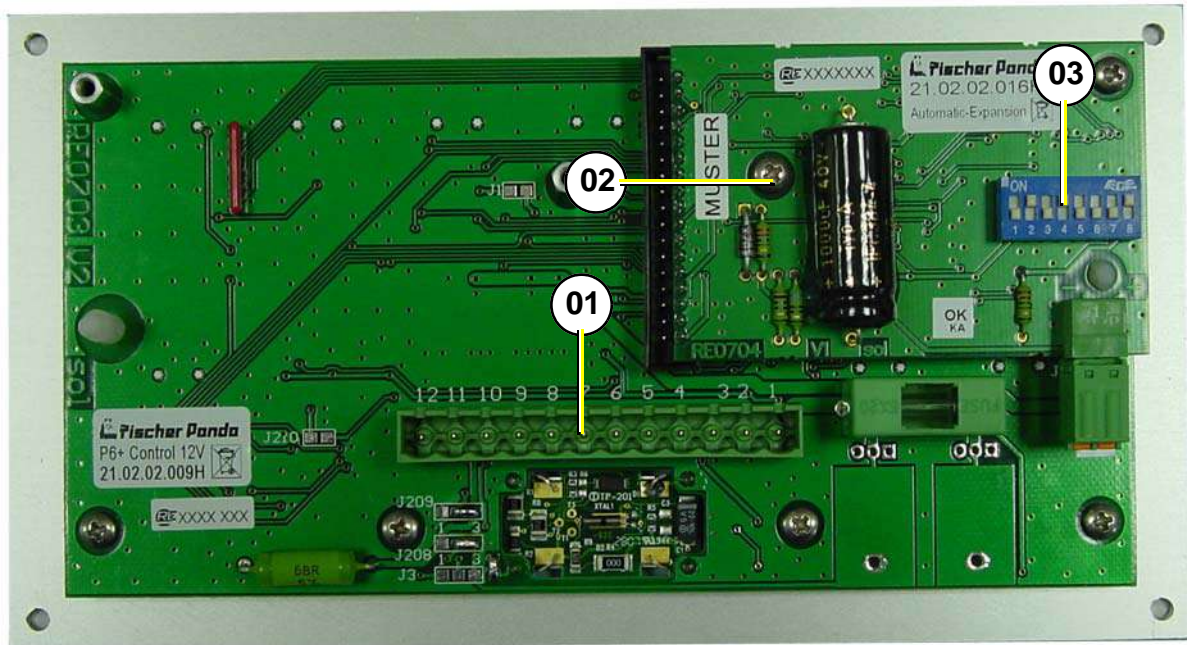




## 11.6 Automatic adapter - optional

Fischer Panda Art. No. 21.02.02.016P

Fig. 11.6-1: Panel 21.02.02.009P with Automatic adapter 21.02.02.016P



- 01. Main terminals
- 02. Automatic adapter 21.02.02.016P
- 03. 8-pole DIP-switch

### 11.6.1 Function:

The automatic adapter RE0704 extends the generator control panel P6+ with an automatic input. A potential-free contact can be attached to this input. If this contact is closed, then the generator, which is attached to the generator control panel P6+, is started automatically. If the contact is opened, then the generator is stopped automatically.

The automatic starting procedure consists of pre-heating (heat) and operating the starter (start). It can be again aborted at any time by opening the contact at the automatic input.

For automatic stopping (stop) the output "Fuel pump" (clamp 9 generator control panel) is switched off. The time for the automatic stop procedure can be terminated only by switching off generator control panel prematurely.

The times for "heat", "start" and "stop" are separately adjustable (see below).

The additional automatic adapter switched on and off using the generator control panel with its push buttons "on" and "off".

If the contact at the automatic input is connected, while the generator control panel is switched on, then the automatic starting procedure is carried out.

If the power supply is attached or switched on using the generator control panel, while the contact of the automatic input is closed, then the automatic starting procedure won't be carried out, because the generator control panel is always switched off after attaching the power supply (generator the control panel must have been separate from the power supply for at least 60 s).

**If the contact at the automatic input is closed and if the panel is switched on again after a voltage drop, the automatic start (glow, start) will be introduced.**

**Attention!**



## 11.6.2 The Automatic input:

With (-) characterized connection is connected to GND.

With (+) characterized connection is the input.

The input is connected through a resistance to 12 V (with 24 V-operated internally generated). If the two connections are short circuited over a potential-free contact, then the input current flows.

To be considered for an electronic contact the low input current and the polarity is to be selected.

The high input current is to be selected for an electromechanical contact.

The input is debounced (delay time approx. 1 s).

On the input an external voltages must not be set.

Fig. 11.6.2-1: Data

Data:	
Parameter	Information
Operation voltage	The automatic adapter power is supplied via the generator control panel P6+. The same absolute maximum ratings obtain as with the generator control panel P6+.
Operation temperature	The same absolute maximum ratings obtain as with the generator control panel P6+.
Proper power consumption	10 mA - 20 mA
Tolerance of times	± 10 %

Fig. 11.6.2-2: Settings

8-pole DIP-switch S1 settings (S1.1 to S1.8):										
		standard	S1.1	S1.2	S1.3	S1.4	S1.5	S1.6	S1.7	S1.8
Heat-time	2,5 s		OFF	OFF						
	5 s		ON	OFF						
	10 s	X	OFF	ON						
	20 s		ON	ON						
Start-time	8 s	X			OFF					
	16 s				ON					
Stop-time	16 s					OFF	OFF			
	32 s	X				ON	OFF			
	64 s					OFF	ON			
	128 s					ON	ON			
Operation-mode	Normal	X						OFF		
	Test (all times over 16)							ON		
Input current	1,25 mA									OFF
	7 mA	X								ON

**The automatic adapter must only be used together with an additional device. The starter should only be switched on when the generator stationary shut-down!** **Attention!**



### 11.6.3 Terminal connections

Connection for the automatic adapter X2 (row with odd pin numbers // I/O view from operating panel)

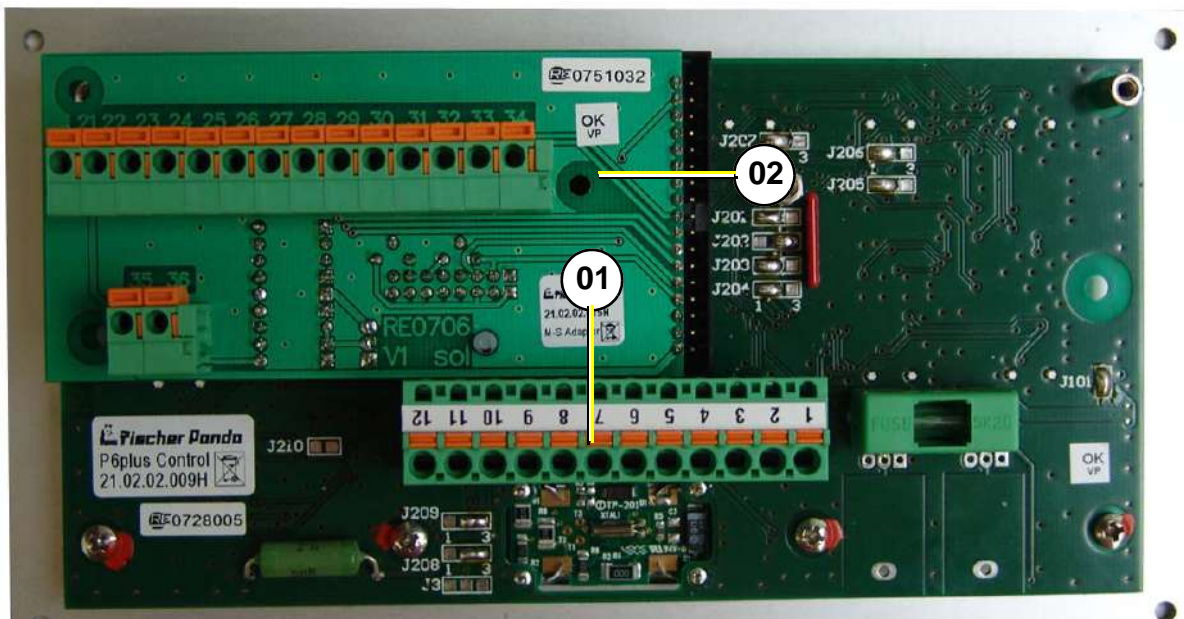
Fig. 11.6.3-1: Terminal connections automatic adapter

Pin-no.	Pin-name	I / O	Description
1	VBF	O	power supply + (operation voltage behind fuse)
3	GND	O	power supply - (ground)
5	VBFS	O	power supply + switched (voltage Pin 1, with panel switched on)
7	12V	O	power supply + switched, at 12 V-operation over closed soldered jumper J101 connected with VBFS (at optional 24 V-operation: VBFS over internal voltage regulator at 12,9 V regulated)
9	GND	O	power supply - (ground)
11	GND	O	power supply - (ground)
13	/Heat-signal	I	Heat is active, if the input is switched to GND
15	/Start-signal	I	Start is active, if the input is switched to GND
17	GND	O	power supply - (ground)
19	GND	O	power supply - (ground)
21	GND	O	power supply - (ground)
23	GND	O	power supply - (ground)
25	GND	O	power supply - (ground)
27	/Stop-signal	I	The Fuel pump signal is switched off, as long as the input is switched to GND, (also when starting)
29	FP-Int	O	Fuel pump signal internally, decoupled over diode from external signal
31	/Fault-signal	O	Output is switched to GND, if an error is present (inputs 3, 4, 5, 11 and 12, if configured and generally for 2 s, after switching on the panel)
33	GND	O	power supply - (ground)

## 11.7 Master-Slave adapter - optional

### 11.7.1 Fischer Panda Art. No. 21.02.02.015P, 12 V-version

Fig. 11.7.1-1: Panel 21.02.02.009P with master-slave adapter 21.02.02.015P

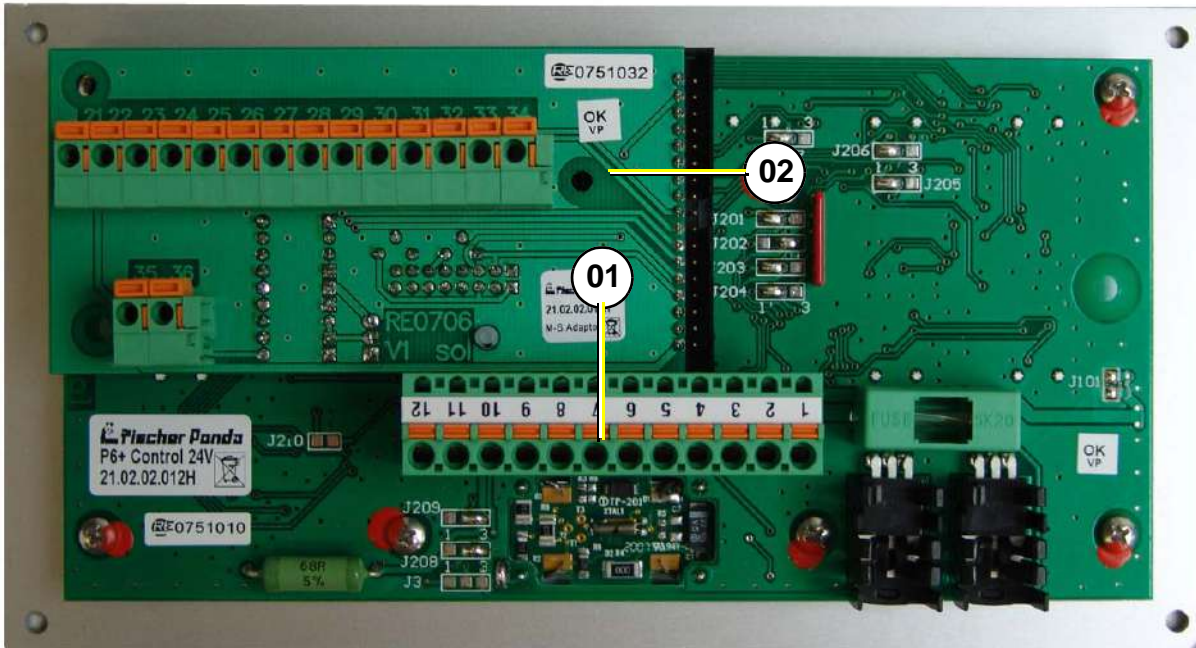


- 01. Main terminals
- 02. Master-slave adapter 21.02.02.015P



## 11.7.2 Fischer Panda Art. No. 21.02.02.01P, 24 V-version

Fig. 11.7.2-1: Panel 21.02.02.012P with master-slave adapter 21.02.02.015P



- 01. Main terminals
- 02. Master-slave adapter 21.02.02.015P

With the Master-Slave-Adapter RE0706 two Generator Control Panels P6+ RE0703 can be connected to a Master-Slave-Combination. In addition on each Generator Control Panel P6+ an Master-Slave-Adapter RE0706 is installed. The Generator Control Panel P6+ is interconnected by the 14pole connecting terminals on the Master-Slave-Adapters 1:1. The Master-Panel is hereby defined when the generator is connected to the main connector. Thus, the main connector of the Slave-Panel should not be occupied (unconnected).

The solder jumpers on the Master-Panel have to be coded in the same manner as for a Master-Panel without a Slave-Panel as in normal operation. The solder jumpers on the Slave-Panel are coded as for slave operation (please see the appropriate adjustment pages for the Generator Control Panel P6+ RE0703).

The Master-Panel and Slave-Panel are identical, and only differs as a result of the coding. Both Master-Slave-Panels are also identical.

### 11.7.3 Terminal Connections:

- X2: (14polig, 21 - 34) master Slave connection (1:1 wire)
- X3: (2polig, 35 - 36) 35: Panel on signal of the Generator Control Panel P6+ RE0703  
36: Error signal of the Generator Control Panel P6+ RE0703

The Panel-ON-Signal is active when the panel is switched on.

The error signal is so long active, as the panel recognizes an error, which must lead to switching the generator off.

The output voltage corresponds to the operating voltage of the Generator Control Panel P6+ less 0,7 V - 1,4 V. Each output has a free wheeling diode which short circuits externals voltage supplies under 0 V and a decoupling diode which decouples the circuitry from external power feeding.

### 11.7.4 Fuse:

A 0,8AT fuse must be installed on the Master-Panel.

## 11.7.5 Terminal connections

### 11.7.5.1 Terminal X2 (IN/OUT from view Master-Operating-Panel)

Fig. 11.7.5-1: Terminal connections terminal X2 (IN/OUT from the view of the master-control-panel)

Pin-No.	Pin-name	IN / OUT	Description
21	VBF	O	power supply + (operation voltage behind fuse 12 Vdc or 24 Vdc depending on system)
22	GND	O	power supply - (ground)
23	ON-Signal	I / O	Panels are switched on, if the connection is switched using a push button (on master or slave) to VBF
24	OFF-Signal	I / O	Panels are switched off, if the connection is switched using a push button (on master or slave) to VBF
25	/Heat-Signal	I / O	Heat is active, if the connection is switched over a push button (on master or Slave) to GND
26	/Start-Signal	I / O	Start is active, if the connection is switched over a push button (on master or Slave) to GND
27	LED-T-Engine	O	Output for LED T-Engine on the Slave panel, is switched to GND, if the LED is illuminated
28	LED-Water leak (Replace Air filter)	O	Output for LED Water leak on the Slave panel, is switched to GND, if the LED is illuminated
29	LED-Oil-Press	O	Output for LED Oil-Press on the Slave panel, is switched to GND, if the LED is illuminated
30	LED-AC-Fault (Fuel Level)	O	Output for LED AC-Fault on the Slave panel, is switched to GND, if the LED is illuminated
31	LED-T-Winding	O	Output for LED T-Winding on the Slave panel, is switched to GND, if the LED is illuminated
32	DC-Control	O	Output for LED DC-Control-display on the Slave panel. The DC control signal is ground through 1:1.
33	AC-Control		Output for LED AC-Control-display on the Slave panel. The AC control signal is ground through 1:1.
34	VBFS	O	power supply + switched (otherwise like 21, VBF)

The use of these connections for other purposes, other than the master-slave connection of two generator control panels, is generally forbidden. In individual cases, after consultation and clarifying the technical details, a release for another use can, if technically possible, be allowed.

### 11.7.5.2 Terminal X3

Fig. 11.7.5.2-1: Terminal connections terminal X3

Pin-No.	Pin-name	IN / OUT	Description
35	Panel ON	O	With panel (ON/OFF) switched voltage of clamp X2.1 (VBF). (Consider notes 1-4)
36	Error	O	Output is switched on, if a critical error is present. (Consider notes 1-4)

**Notes:**

1. Power rating of the output: max. 0,5 A in continuous operation and briefly 1,0 A.
2. The supply of all output currents may not exceed (less 0,2 A power consumption) the rated current of the safety device of the control panel.
3. The output has a free wheeling diode, which short circuit negative voltages (related to GND).
4. The output has a Z-diode, which prevents an overvoltage (related to GND) into the output.



### 11.7.6 Configuration and adjustment

#### 11.7.6.1 Configuration and setting sheet KE05

Standard jumpering for use as Slave-Panel in connection with **two** Master-Slave-Adapters RE0706 and a Generator Control Panel P6+ RE0703 as Master-Panel. Panel only for 12 V-operation.

The safety device is installed with the value 0,63 AT. The circuit parts for 24 V-operation are not equipped.

Fig. 11.7.6-1: Settings of soldered jumper for this configuration (column Conf.)

Jumper	Status	Conf.	Description
J1	closed		during operation of the start button heat is along-operated
	open	XM	Function deactivated
J3	1-2		Dynamo excitation resistor 68R is switched on with Fuel-Pump (1)
	2-3		Dynamo excitation resistor 68R is switched on with Panel-ON (1)
	open	XM	Dynamo excitation resistor is deactivated
J101	closed	M	12 V - operation
	open	M	<del>24 V - operation</del> (not possible)
J201	1-2		T-Engine-input, for contact, which opens in case of error (2)
	2-3	XM	T-Engine-input, for contact, which closes in case of error (2)
J202	1-2		Water leak-input / Replace air filter, for contact, which opens in case of error (2)
	2-3	XM	Water leak-input / Replace air filter, for contact, which closes in case of error (2)
J203	1-2		Oil-Press-input, for contact, which opens in case of error (2)
	2-3	XM	Oil-Press-input, for contact, which closes in case of error (2)
J204	1-2		AC-Fault-input / Fuel level, for contact, which opens in case of error (2)
	2-3	XM	AC-Fault-input / Fuel level, for contact, which closes in case of error (2)
J205	1-2		T-Winding-input, for contact, which opens in case of error (2)
	2-3	XM	T-Winding-input, for contact, which closes in case of error (2)
J206	1-2	M	Input Water leak has red LED and switches off
	2-3	M	Input Water leak has yellow LED and does not switch off
J207	1-2	M	Input AC-Fault has red LED and switches off
	2-3	M	Input AC-Fault has yellow LED and does not switch off
J208	1-2	M	DC-Control-Signal (-) = OK dynamo 12 V at Kubota Z 482 / D 722 engines
	2-3	M	DC-Control-Signal (+) = OK three-phase DC-alternator
J209	1-2	M	DC-Control-Signal (-) = OK dynamo 12 V at Kubota Z 482 / D 722 engines
	2-3	M	DC-Control-Signal (+) = OK three-phase DC-alternator
J210	closed		Input AC-Fault has Pull-Up-current $\geq 10$ mA
	open	XM	Input AC-Fault has Pull-Up-current $\geq 2,5$ mA

The solder jumpers are marked on the printed circuit board (with jumper no. and at three-part solder jumper with soldering surface no.)

X = Jumper must be so set

XM = Jumper, function must be so set on the master panel is selected

M = Jumper must be set exactly the same, as on the master panel.

(1): Equivalent resistance for load control lamp e.g. for use with three-phase alternator also integrated automatic controller of Bosch. The resistance value is  $68 \Omega$  3 W, i.e. only for 12 V.

(2): A closed contact switches the appropriate input to GND.

### 11.7.6.2 Configuration and setting sheet KE06

Standard jumpering for use as Slave-Panel in connection with **two** Master-Slave-Adapters RE0706 and a Generator Control Panel P6+ RE0703 as Master-Panel. Panel for 24 V-operation. (over attitude of solder jumper J101 alternatively 12 V-operation is possible)

The safety device is installed with the value 0,63 AT.

The circuit parts for 24 V-operation are not equipped.

Fig. 11.7.6.2-1: Settings of soldered jumper for this configuration (column Conf.)

Jumper	Status	Conf.	Description
J1	closed		during operation of the start button heat is along-operated
	open	XM	Function deactivated
J3	1-2		Dynamo excitation resistor 68R is switched on with Fuel-Pump (1)
	2-3		Dynamo excitation resistor 68R is switched on with Panel-ON (1)
	open	XM	Dynamo excitation resistor is deactivated
J101	closed	M	12 V - operation
	open	M	24 V - operation
J201	1-2		T-Engine-input, for contact, which opens in case of error (2)
	2-3	XM	T-Engine-input, for contact, which closes in case of error (2)
J202	1-2		Water leak-input / Replace air filter, for contact, which opens in case of error (2)
	2-3	XM	Water leak-input / Replace air filter, for contact, which closes in case of error (2)
J203	1-2		Oil-Press-input, for contact, which opens in case of error (2)
	2-3	XM	Oil-Press-input, for contact, which closes in case of error (2)
J204	1-2		AC-Fault-input / Fuel level, for contact, which opens in case of error (2)
	2-3	XM	AC-Fault-input / Fuel level, for contact, which closes in case of error (2)
J205	1-2		T-Winding-input, for contact, which opens in case of error (2)
	2-3	XM	T-Winding-input, for contact, which closes in case of error (2)
J206	1-2	M	Input Water leak has red LED and switches off
	2-3	M	Input Water leak has yellow LED and does not switch off
J207	1-2	M	Input AC-Fault has red LED and switches off
	2-3	M	Input AC-Fault has yellow LED and does not switch off
J208	1-2	M	DC-Control-Signal (-) = OK dynamo 12 V at Kubota Z 482 / D 722 engines
	2-3	M	DC-Control-Signal (+) = OK three-phase DC-alternator
J209	1-2	M	DC-Control-Signal (-) = OK dynamo 12 V at Kubota Z 482 / D 722 engines
	2-3	M	DC-Control-Signal (+) = OK three-phase DC-alternator
J210	closed		Input AC-Fault has Pull-Up-current $\geq 10$ mA
	open	XM	Input AC-Fault has Pull-Up-current $\geq 2,5$ mA

The solder jumpers are marked on the printed circuit board (with jumper no. and at three-part solder jumper with soldering surface no.)

X = Jumper must be so set

XM = Jumper, function must be so set on the master panel is selected

M = Jumper must be set exactly the same, as on the master panel,

(1): Equivalent resistance for load control lamp e.g. for use with three-phase alternator also integrated automatic controller of Bosch. The resistance value is 68  $\Omega$  3 W, i.e. only for 12 V.

(2): A closed contact switches the appropriate input to GND.



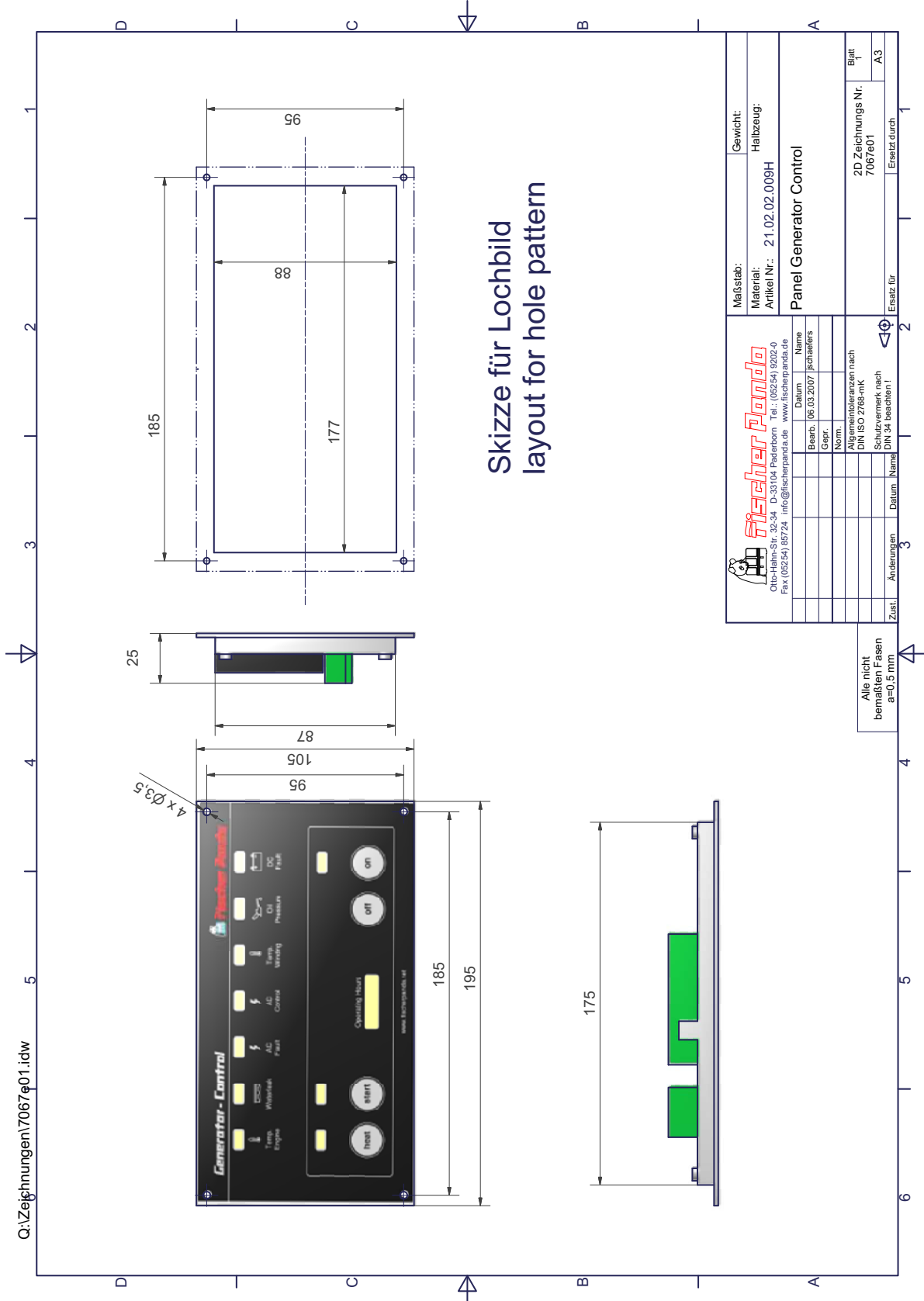
Leere Seite / Intentionally blank



# 12. Measurements

## 12.1 Hole pattern

Fig. 12.1-1: Hole pattern





Leere Seite / Intentionally blank